

BFM

Balanced Flue Commercial
Water Heater

BFM - 30/50/80/100/120



Installation, User and Service
Manual

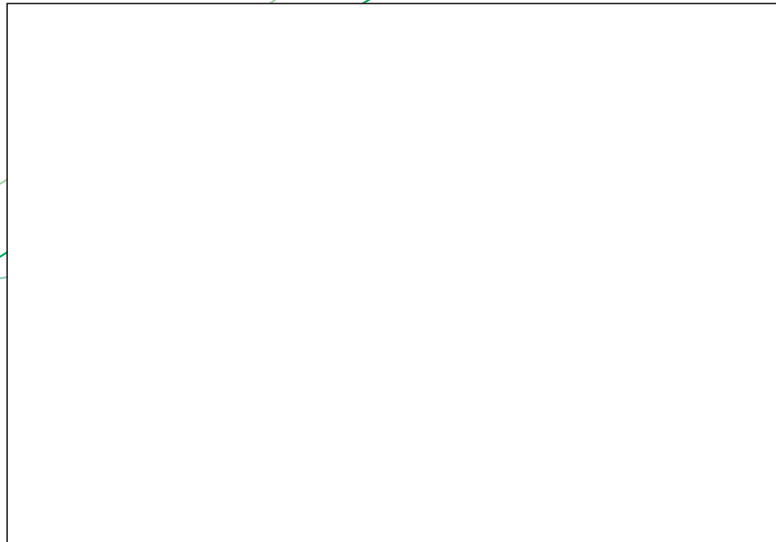

your installer

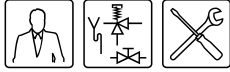

Read this manual carefully

Warning

Read this manual carefully before starting up the water heater. Failure to read this manual and to follow the instructions in this manual may lead to accidents, personal injury, and damage to the appliance.

Copyright © 2015 A.O. Smith water Products Company

All rights reserved.

Nothing from this publication may be copied, reproduced and/or published by means of printing, photocopying or by whatsoever means, without the prior written approval of A.O. Smith water Products Company.

A.O. Smith water Products Company reserves the right to modify specifications stated in this manual.

Trademarks

Any brand names mentioned in this manual are registered trademarks of their respective owners.

Liability

A.O. Smith water Products Company accepts no liability for claims from third parties arising from improper use other than that stated in this manual and in accordance with the General Conditions registered at the Eindhoven Chamber of Commerce.

Refer further to the General Conditions. These are available on request, free of charge.

Although considerable care has been taken to ensure a correct and suitably comprehensive description of all relevant components, the manual may nonetheless contain errors and inaccuracies.

Should you detect any errors or inaccuracies in the manual, we would be grateful if you would inform us. This helps us to further improve our documentation.

More information

If you have any comments or queries concerning any aspect related to the appliance, then please do not hesitate to contact:

A.O. Smith water Products Company

PO Box 70

5500 AB Veldhoven

Netherlands

Telephone: (free) 0870 - AOSMITH
0870 - 267 64 84

General: +31 40 294 25 39

Fax: +31 40 294 25 00

E-mail : info@aosmith.nl

Website: www.aosmithinternational.com

In the event of problems with connecting to the gas, electricity or water supply, please contact your installation's supplier/installation engineer .

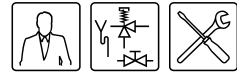

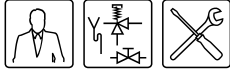
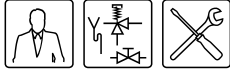

Table of contents

1	Introduction	7
1.1	About the appliance	7
1.2	What to do if you smell gas-	7
1.3	Regulations	7
1.4	Maintenance-	8
1.5	Forms of notation	8
1.6	Target groups	8
1.7	Overview of this document	9
2	Working principle of the appliance-	11
2.1	Introduction	11
2.2	General working principle of the appliance	12
2.3	The appliance's heating cycle	13
2.4	Protection for the appliance	14
2.5	Safety of the installation	15
3	Installation	17
3.1	Introduction	17
3.2	Packaging	17
3.3	Ambient conditions-	18
3.4	Technical specifications	20
3.5	Installation diagram	25
3.6	Water connections, Vented-	26
3.7	Water connections, Unvented	27
3.8	Gas connection	28
3.9	Air supply and flue	29
3.10	Electrical connection	35
3.11	Checking the supply pressure and burner pressure	37
4	Conversion to a different gas category	41
4.1	Conversion	41
4.2	Orifice replacement	42
4.3	Replacement of burner pressure regulator or blank plate BFM 30-50-80-100-	43
5	Filling-	45
5.1	Filling unvented installations	46
5.2	Filling vented installations	46
6	Draining	47
6.1	Draining unvented installations	48
6.2	Draining vented installations	48
7	The control panel-	49
7.1	Introduction	49
7.2	Control panel	49
7.3	Explanation of icons	49
7.4	ON/OFF switch	49
7.5	Control thermostat	49
7.6	Burner control reset button	49

Table of contents

8	Status of the appliance	51
8.1	Introduction	51
8.2	Operating modes	51
8.3	Error conditions	51
9	Starting and running	53
9.1	Introduction	53
9.2	Starting the appliance	53
9.3	The appliance's heating cycle	53
10	Shutting down	55
10.1	Introduction	55
10.2	Shutting down the appliance for a brief period (OFF mode)	55
10.3	Isolating the appliance from the mains	55
10.4	Shutting the appliance down for a long period	55
10.5	Disposal	55
11	Troubleshooting	57
11.1	Introduction	57
11.2	Troubleshooting: general errors	58
11.3	Troubleshooting: insufficient hot water	59
11.4	Troubleshooting: No hot water	60
12	Performing maintenance	63
12.1	Introduction	63
12.2	Preparation for maintenance	63
12.3	Water-side maintenance	64
12.4	Gas-side maintenance	66
12.5	Finalising maintenance	66
13	Warranty (certificate)	67
13.1	General warranty	67
13.2	Tank warranty	67
13.3	Conditions for Installation and use	67
13.4	Exclusions	68
13.5	Scope of the warranty	68
13.6	Claims	68
13.7	Obligations of A.O. Smith	68
14	Electrical diagram	69
14.1	Introduction	69
14.2	BFM Electrical Diagram	70



1 Introduction

1.1 About the appliance



This manual describes how to install, service and use the BFM appliance. The BFM appliance is a gas-fired sealed boiler with a fan in the air supply. The parallel or concentric chimney connections are appliance-dependent. Possible installation types are C13 or C33. The information in this manual applies to the: BFM 30, BFM 50, BFM 80, BFM 100 and BFM 120.

The appliance has been manufactured and equipped in accordance with the European standard for gas-fired storage water heaters for the production of domestic hot water (EN 89). The appliances are therefore compliant with the European Directive for Gas Appliances, and are entitled to bear the CE mark.

Warning

Read this manual carefully before starting up the water heater. Failure to read the manual and to follow the printed instructions may lead to personal injury and damage to the appliance.

1.2 What to do if you smell gas

Warning

If there is a **gas smell**:

No naked flames! No smoking!

Avoid causing sparks! Do not use any electrical equipment or switch, i.e. no telephones, plugs or bells!

Open windows and doors!

Shut off the mains gas supply valve!

Warn occupants and leave the building!

After leaving the building, alert the gas distribution company or your installation engineer.

1.3 Regulations

As the (end) user, installation engineer or service and maintenance engineer, you must ensure that the entire installation complies, as a minimum, with the official local:

- building regulations;
- energy supplier's directives for existing gas installations;
- directives and technical guidelines for natural gas installations;
- safety requirements for low-voltage installations;
- regulations governing the supply of drinking water;
- regulations governing ventilation in buildings;
- regulations governing the supply of air for combustion;
- regulations governing the discharge of products of combustion;
- requirements for installations that consume gas;
- regulations governing indoor waste water disposal;
- regulations imposed by fire brigade, power companies and municipality.

Furthermore, the installation must comply with the manufacturer's instructions.

Note

Later amendments and/or additions to all regulations, requirements and guidelines published on or prior to the moment of installing, will apply to the installation.

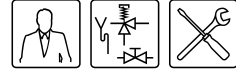

1.4 Maintenance

A service should be carried out at least once a year, both on the water side and on the gas side. Maintenance frequency depends, among other things, on the water quality, the average burning time per day and the set water temperature.

 **Note**

To determine the correct maintenance frequency, it is recommended to arrange for the service and maintenance engineer to check the appliance on both the water and gas side within three months following installation. Based on this check, the best maintenance frequency can be determined.

 **Note**

Regular maintenance extends the service life of the appliance.

 **Note**

Both the end user and the service and maintenance engineer are responsible for regular maintenance. They will need to establish clear agreements on this.

 **Note**

If the appliance is not regularly maintained, the warranty will become void.

1.5 Forms of notation

The following notation is used in this manual:

 **Note**

Important information.



Caution

Ignoring this information can lead to the appliance being damaged.



Warning

Failure to carefully read this information may lead to personal injury and serious damage to the appliance.



1.6 Target groups

The three target groups for this manual are:

- (end) users;
- installation engineers;
- service and maintenance engineers.

Symbols on each page indicate the target groups for whom the information is intended. See the table.

Target group symbols































Symbol	Target group
	(End) user
	Installation engineer
	Service and maintenance engineer



1.7 Overview of this document

The table provides an overview of the contents of this document.

Contents of this document

Chapter	Target groups	Description
<u>Working principle of the appliance</u>	  	This chapter describes how the appliance functions.
<u>Installation</u>	 	This chapter describes the installation activity to be completed before you actually start up the appliance.
<u>Filling</u>	  	This chapter describes how to fill the appliance.
<u>Draining</u>	  	This chapter describes how to drain the appliance.
<u>The control panel</u>	  	This chapter describes the general operation of the appliance and explains how to use the control panel.
<u>Status of the appliance</u>	  	This chapter describes the status (mode or condition) that the appliance may have, and possible actions to take.
<u>Starting and running</u>	  	This chapter describes how to start the appliance running. The general heating cycle of the appliance is also described.
<u>Shutting down</u>	  	This chapter describes how to shut the appliance down for a brief or long period of time.
<u>Troubleshooting</u>	  	This chapter is mainly intended for the installation engineer and the service and maintenance engineer. It describes appliance errors. A table is included stating potential symptoms, causes and solutions. End users may also refer to this chapter for additional information about the appliance.
<u>Performing maintenance</u>		This chapter sets out the maintenance tasks to be carried out during a service.
<u>Warranty (certificate)</u>	  	This chapter states the warranty terms and conditions.



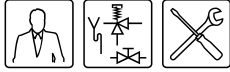

2 Working principle of the appliance

2.1 Introduction

Topics covered in this chapter:

- General working principle of the appliance;
- The appliance's heating cycle;
- Protection for the appliance;
- Safety of the installation.

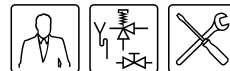

2.2 General working principle of the appliance

The figure shows a cut-away view of the appliance.

Cut-away view of the appliance

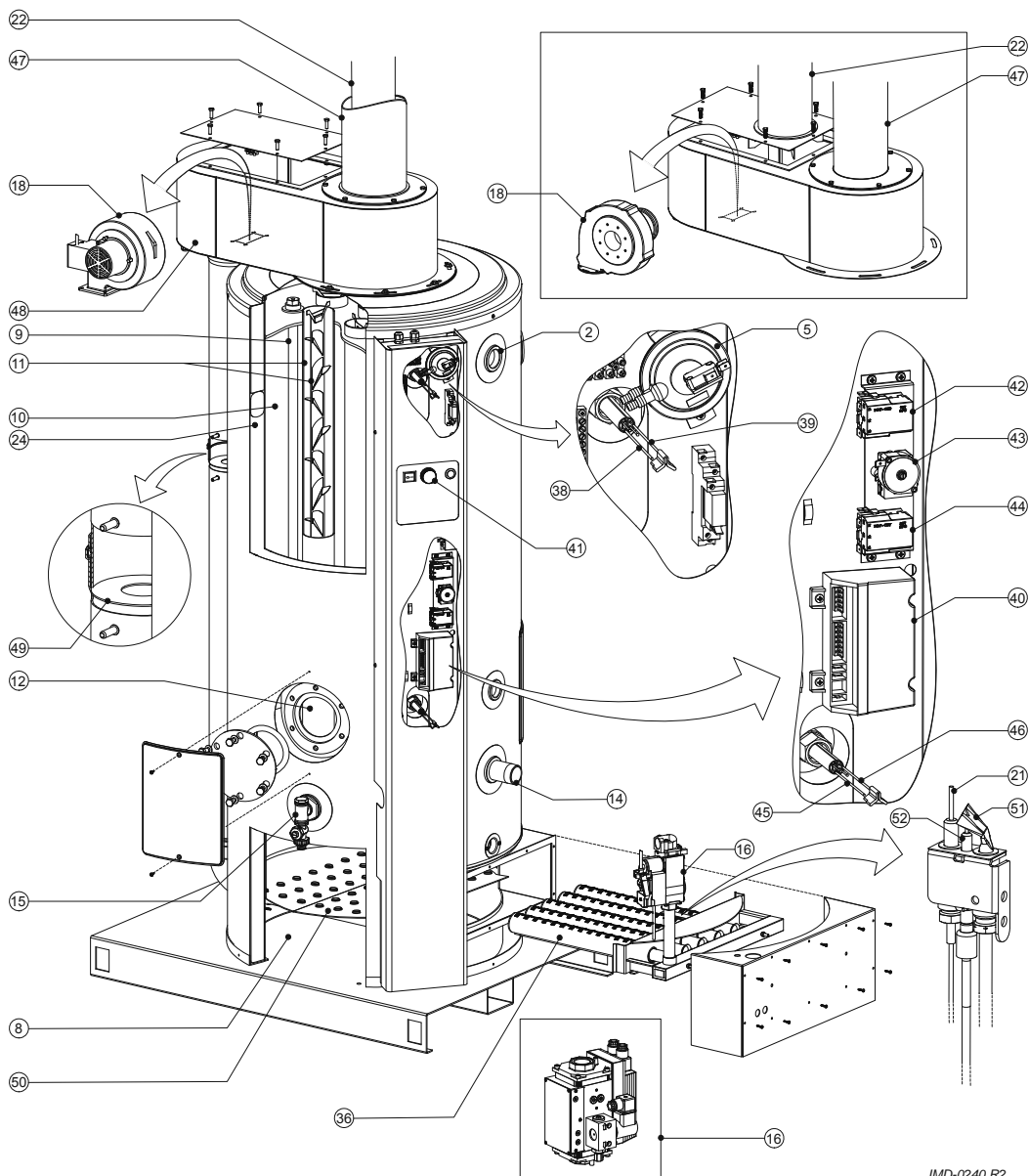

IMD-0240 R2

Legend

Only applicable numbers are mentioned.

2. hot water outlet

5. pressure switch

8. combustion chamber

9. anode

10. tank

11. heat exchanger

12. inspection and cleaning opening

14. cold water inlet

15. drain valve

16. gas control valve

18. fan

21. flame probe

22. chimney pipe

24. insulation layer

36. bar burners/burner tray

38. safety thermostat sensor

39. high-limit thermostat sensor

40. burner control

41. control thermostat

42. high-limit thermostat

43. safety thermostat

44. frost thermostat

45. control thermostat sensor

46. frost thermostat sensor

47. air supply

49. air restrictor

50. combustion chamber with air distribution plate

51. pilot burner

52. spark igniter

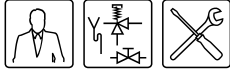

In this appliance, the cold water enters the bottom of the tank through the cold water inlet (14). The heat of combustion is conducted to the water by the combustion chamber (50) and heat exchanger (11). The heated tap water leaves the tank through the hot water outlet (2). Once the appliance is completely filled with water, it will constantly be under mains water pressure. When hot water is drawn from the appliance, it is immediately replenished with cold water.

The air required for combustion is forced into the combustion chamber by the fan.

The gas required for combustion flows via the gas control valve (16) in the manifold. The gas control valve for the BFM 120 is non-standard (see box). Orifices are mounted in the manifold. The gas is injected into the burner bars at pressure from these orifices (36). The burner bars together form the burner tray. The injection of gas into the burner bars also draws in the primary air from the combustion chamber, which is required for combustion. The narrow opening in the orifice causes the gas flow to accelerate. This in turn causes a partial vacuum. It is this partial vacuum that draws in the air (the Venturi effect).

Ignition of the gas/air mixture takes place in two stages. First, the pilot flame is ignited by a spark igniter. This pilot flame then ensures that the complete ignition takes place.

The flue gases released by this combustion are led through the heat exchanger. The heat exchanger is composed of flue tubes that contain flue baffles. These retard the flow of the flue gases, thereby increasing the thermal efficiency of the appliance.

The flue gases are exhausted from the appliance via the top box (46). The top box of the BFM 100 and 120 is non-standard (see box).

An air distribution plate (50) mounted below the burner tray radiation shield also serves as a radiation shield. Any condensation that forms is drained towards the siphon via the air distribution plate.

The PU insulation layer (24) prevents heat loss. The inside of the tank is enamelled to protect against corrosion. The anodes (9) offer extra protection.

2.3 The appliance's heating cycle

The entire appliance is controlled by the burner control (40) and the control thermostat (41) or frost thermostat (44). The control thermostat and frost thermostat both independently measure the water temperature (T_{water}). The appliance's heating cycle is activated as soon as T_{water} falls below the threshold value (T_{set}). The value of T_{set} depends on the selected mode of the appliance (8.2 "Operating modes"). When the appliance is in OFF mode (frost protection), this value is determined by the frost thermostat (threshold value = 20 °C). When the appliance is in 'ON mode', the threshold value can be set via the control thermostat (± 40 °C - ± 70 °C).

The instant T_{water} falls below T_{set} , the appropriate thermostat (control or frost) will close, and the burner control will identify a heat demand. The gas control valve will open, and the gas will mix with air. This mixture is ignited by the spark igniter, and the water becomes heated. As soon as T_{water} rises above T_{set} , the thermostats will open once more. The heat demand is suspended, and the burner control stops the heating cycle.

The thermostats have a certain margin both when opening and when closing. We refer to this margin as hysteresis. The hysteresis cannot be adjusted.

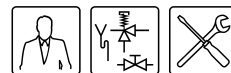

2.4 Protection for the appliance

2.4.1 Introduction

The burner control monitors the water temperature by means of thermostats, and ensures that the combustion is safe. This takes place using:

- the Water temperature protection;
- the Flame probe;
- the Pressure switch.

2.4.2 Water temperature protection

By means of the frost, high-limit and safety thermostats, the burner control monitors three temperatures that are important for safety. The table explains the working principle of the thermostats with sensors.

Temperature protection

Protection	Description
Frost thermostat	When the frost thermostat sensor (46) measures a temperature of 20 °C or less, the heating cycle (2.3 "The appliance's heating cycle") will start.
High-limit thermostat	When the high-limit thermostat sensor (39) measures a temperature higher than 84 °C, the high-limit thermostat will open. The heat demand is terminated and the burner control halts the heating cycle until the high-limit thermostats close once more. At that moment the burner control will reset the appliance and the heating cycle will restart. The high-limit safeguard serves to prevent overheating and/or excessive formation of scale in the appliance.
Safety thermostat	When the safety thermostat sensor (38) measures a temperature higher than 93 °C, the safety thermostat will open. The heat demand is terminated and the burner control will immediately halt the heating cycle. The burner control will go into a lockout error state. This must be manually reset before the appliance can resume operation.

2.4.3 Pressure switch

The pressure switch ensures the discharge of flue gases and the supply of incoming air during the pre-purge and normal running of the appliance. The default state of the pressure switch is open. When sufficient pressure difference is reached, the pressure switch closes. However, in the event of a fault, the pressure switch is tripped open, and the heating cycle is interrupted. The table shows the trip point per appliance.



Note

The trip point of the pressure switch is not adjustable.

Pressure switch trip points

Appliance	Closing pressure difference	Opening pressure difference
BFM 30	> 200 Pa	< 170 Pa
BFM 50	> 270 Pa	< 240 Pa
BFM 80	> 255 Pa	< 225 Pa
BFM 100	> 610 Pa	< 580 Pa
BFM 120	> 255 Pa	< 225 Pa

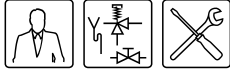

2.5 Safety of the installation

2.4.4 Flame probe

To ensure that no gas can flow when there is no combustion, the water heater is fitted with a flame probe (21). The burner control uses the ionisation-detecting properties of this probe for flame detection. The burner control closes the gas valve the instant it determines that there is a gas flow but no flame is present.

In addition to the appliance's standard built-in safety monitoring, the appliance must also be protected by an expansion vessel, expansion valve, pressure reducing valve, non-return valve and a T&P valve.

The use of an expansion vessel, expansion valve and/or pressure reducing valve depends on the type of installation: unvented or vented.

2.5.1 Unvented installation

With an unvented installation, an expansion valve valve and expansion vessel prevent the buildup of excessive pressure in the tank. This prevents damage being caused to the enamelled coating (in the appliance) or to the tank. A non-return valve prevents excessive pressure buildup in the water supply system. This valve also prevents water from flowing backwards from the tank into the cold water supply system. The pressure reducing valve protects the installation against an excessively high water supply pressure (> 8 bar). These components are fitted to the cold water pipe ([3.6 "Water connections, Vented"](#)).

2.5.2 Vented installation

With a vented installation, excess pressure is taken up by the open cold water head tank. The height of the head tank determines the working pressure in the water heater, which may not exceed 8 bar. The installation must also be fitted with a vent pipe from the hot water pipe, that opens into the cold water tank.

Ideally, the vent pipe should discharge into a separate tundish/drain or otherwise to the open cold water head tank. The water heater should also be fitted on the hot water side with a stop valve ([3.7.3 "Hot water side"](#)).

2.5.3 T&P valve

A T&P valve is only mandatory in an unvented installation. However, A.O. Smith also recommends the use of a T&P valve in vented installations.

A T&P (Temperature and Pressure Relief) valve monitors the pressure in the tank and the water temperature at the top of the tank. If the pressure in the tank becomes excessive (> 10 bar) or the water temperature is too high (> 97 °C), the valve will open. The hot water can now flow out of the tank. Because the appliance is under water supply pressure, cold water will automatically flow into the tank. The valve remains open until the unsafe situation has been rectified. The appliance is fitted standard with a connecting point for a T&P valve ([3.7.3 "Hot water side"](#)).

2

Working principle of the appliance

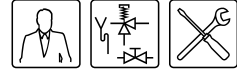



3 Installation

Warning

Installation work should be carried out by an approved installation engineer in compliance with the general and local regulations imposed by the gas, water and power supply companies and the fire service.

The appliance may only be installed in a room that complies with the requirements stated in national and local ventilation regulations ([1.3 "Regulations"](#)).

3.1 Introduction

This chapter describes the installation activities to be carried out before the appliance may be started up ([9 "Starting and running"](#)), in particular:

- [Packaging](#);
- [Ambient conditions](#);
- [Technical specifications](#);
- [Water connections, Vented](#);
- [Water connections, Vented](#);
- [Gas connection](#);
- [Air supply and flue](#);
- [Electrical connection](#);
- [Checking the supply pressure and burner pressure](#).

For a possible conversion to a different gas category, see conversion ([4 "Conversion to a different gas category"](#)).

3.2 Packaging

To avoid damaging the appliance, remove the packaging carefully.

We recommend unpacking the appliance at or near its intended location.

Caution

The appliance may only be manoeuvred in an upright position. Take care that the appliance is not damaged after unpacking.

The packaging prevents damage to the appliance during transport. The packaging material chosen is environmentally friendly, recyclable and relatively easy to dispose of in an environmentally aware way.



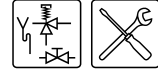

3.3 Ambient conditions

The appliance has a sealed combustion chamber, and obtains its air supply independently of the boiler room. There are therefore no additional ventilation requirements.

Possible installation types are C13 and C33.

3.3.1 Air humidity and ambient temperature

The boiler room must be frost-free, or be protected against frost. The table shows the environmental conditions that must be adhered to for correct functioning of the electronics present in the appliance to be guaranteed.

Air humidity and ambient temperature specifications

Air humidity and ambient temperature	
Air humidity	max. 93% RV at +25 °C
Ambient temperature	Functional: $0 \leq T \leq 60$ °C

3.3.2 Maximum floor load

Allow for the appliance's weight with respect to the maximum floor load; refer to the table.

<i>Weight of the appliance filled with water</i>				
BFM 30	BFM 50	BFM 80	BFM 100	BFM 120
539 kg	543 kg	548 kg	573 kg	573 kg

3.3.3 Water composition

The appliance is intended for heating drinking water. The drinking water must comply with the regulations governing drinking water for human consumption. The table gives an overview of the specifications.

Water specifications

Water composition	
Hardness (alkaline earth ions)	> 1.00 mmol/l: <ul style="list-style-type: none"> • German hardness > 5.6° dH • French hardness > 10.0° fH • English hardness > 7.0° eH
Conductivity	> 125 µS/cm
Acidity (pH value)	7.0 < pH value < 9.5

Note

If the water specifications deviate from those stated in the table, then the tank protection cannot be guaranteed (13 "Warranty (certificate)").

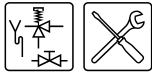

3.3.4 Working clearances

For access to the appliance, it is recommended that the following clearances are observed (see figure):

- AA: around the appliance's control column and cleaning openings: 100 cm.
- BB: all sides of the appliance: 50 cm.
- Above the appliance (room to replace the anodes):
 - 100 cm if using fixed anodes, or
 - 50 cm if using flexible anodes.

If the available clearance is less than 100 cm, flexible magnesium anodes may be ordered.

Note

When installing the appliance, be aware that any leakage from the tank and/or connections can cause damage to the immediate environment or floors below the level of the boiler room. If this is the case, the appliance should be installed above a wastewater drain or in a suitable metal leak tray.

The leak tray must have an appropriate wastewater drain and must be at least 5cm deep with a length and width at least 5cm greater than the diameter of the appliance.

Working clearances

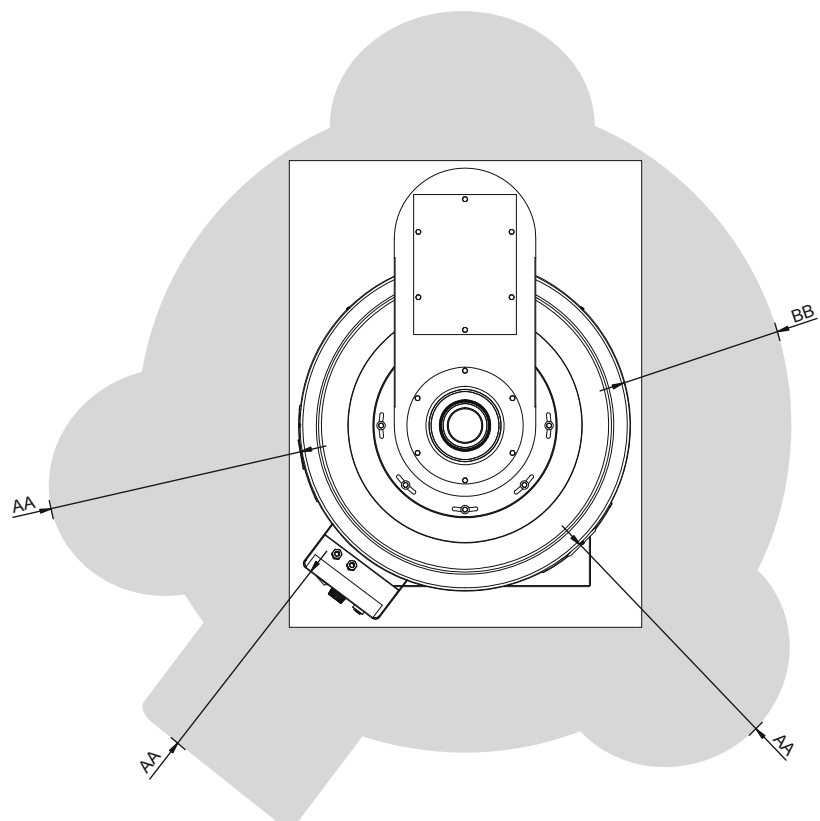

IMD-0241 R1

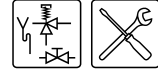

3.4 Technical specifications

The appliance is supplied without accessories. Check the dimensions (3.4.1 "Dimensions of the appliance"), gas data (3.4.3 "Gas data") and other specifications (3.4.2 "General and electrical specifications") of any accessories you plan to use.

3.4.1 Dimensions of the appliance

Plan and elevation of the appliance

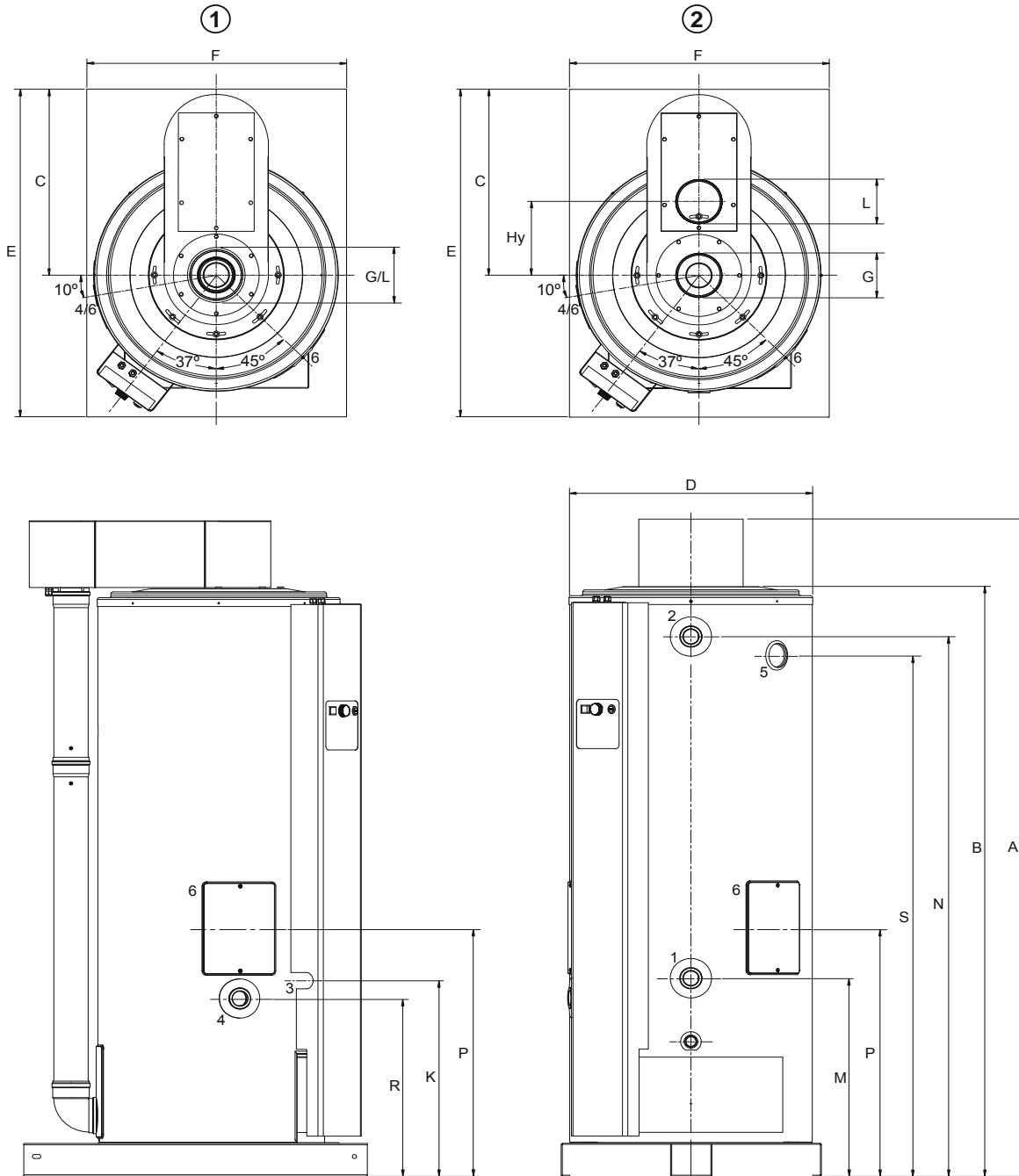

IMD-0057 R5

- (1) = BFM 30-50-80-100
- (2) = BFM 100, 120

Dimensions (all measurements in mm unless otherwise indicated)

Dimension	Description	Unit	BFM 30	BFM 50	BFM 80	BFM 100	BFM 120
A	Total height	mm	2000	2000	2020	2020	2020
B	Height of top of appliance	mm	1800	1800	1820	1820	1820
C	Position on pallet	mm	580	580	580	580	580
D	Appliance diameter	mm	710	710	710	710	710
E	Depth	mm	1000	1000	1000	1000	1000
F	Width	mm	755	755	755	755	755
G	Diameter of chimney flue	mm	80	100	130	130	130
Hy	y-position air supply	mm	-	-	-	235	235
K	Height of gas connection	mm	600	600	600	600	760
L	Diameter of Air supply	mm	125	150	200	130	130
M	Height of cold water supply	mm	600	600	590	590	590
N	Height of hot water outlet	mm	1640	1640	1655	1655	1655
P	Height of cleaning opening	mm	770	770	760	760	760
R	Height of drain valve connection	mm	550	550	540	540	540
S	Height of T&P valve connection	mm	1600	1600	1600	1600	1600
1	Cold water supply connection (external)	-	R1 ¹ / ₂	R1 ¹ / ₂	R1 ¹ / ₂	R1 ¹ / ₂	R1 ¹ / ₂
2	Hot water outlet connection (internal)	-	Rp1 ¹ / ₂	Rp1 ¹ / ₂	Rp1 ¹ / ₂	Rp1 ¹ / ₂	Rp1 ¹ / ₂
3	Gas control valve connection (internal)	-	Rp ³ / ₄	Rp ³ / ₄	Rp ³ / ₄	Rp ³ / ₄	Rp1
4	Drain valve connection (internal)	-	Rp1 ¹ / ₂	Rp1 ¹ / ₂	Rp1 ¹ / ₂	Rp1 ¹ / ₂	Rp1 ¹ / ₂
5	T&P valve connection (internal)	-	1 - 11.5 NPT	1 - 11.5 NPT	Rp1 ¹ / ₂	Rp1 ¹ / ₂	Rp1 ¹ / ₂
6	Cleaning/inspection opening	-	Ø 100	Ø 100	Ø 100	Ø 100	Ø 100

3.4.2 General and electrical specifications

General and electrical specifications

Description	Unit	BFM 30	BFM 50	BFM 80	BFM 100	BFM 120
Volume	ltr.	309	298	253	253	253
Maximum operating pressure	bar	8	8	8	8	8
Empty weight	kg	230	245	295	320	320
Heating-up time $\Delta T = 45\text{ }^{\circ}\text{C}$	minutes	37	22	12	9	8
Diameter of air restrictor	mm	36	42	54	48	64
Number of anodes	-	2	2	4	4	4
Number of bar burners/orifices	-	3	5	7	7	7
Number of flue tubes/flue baffles	-	5	7	16	16	16
Electrical power consumption	W	100	100	100	275	300
Supply voltage (-15% +10% VAC)	volts	230	230	230	230	230
Mains frequency ($\pm 1\text{ Hz}$)	Hz	50	50	50	50	50
IP class	-	20	20	20	20	20

Description	Unit	BFM 30	BFM 50	BFM 80	BFM 100	BFM 120
Load Profile	-	XXL	XXL	XXL	3XL	3XL
Energy Efficiency Class (Energy Label)	-	B	B	B	-	-
Energy Efficiency	%	60	62	60	67	67
Daily Electricity Consumption	kWh	0.099	0.071	0.058	0.152	0.123
Daily Fuel Consumption	kWh GCV	40.324	39.327	40.539	69.917	69.799
Mixed Water 40 °C (V40)	ltr.	1051	∞	∞	2135	∞
Additional Load Profile	-	-	3XL	3XL	-	-
Energy Efficiency	%	-	71	70	-	-
Daily Electricity Consumption	kWh	-	0.112	0.079	-	-
Daily Fuel Consumption	kWh GCV	-	65.936	66.772	-	-
Mixed Water 40 °C (V40)	ltr.	-	526	662	-	-

3.4.3 Gas data

Gas data

Description	Unit	BFM 30	BFM 50	BFM 80	BFM 100	BFM 120
Gas category: 30 through 100 H_2H_3+ , 120: $\text{H}_2\text{H}_3\text{P}$						
Natural gas G20 - 20 mbar						
Orifice diameter	mm	2.60	2.50	2.70	3.20	3.30
Diameter of pilot flame orifice	mm	0.56/0.41	0.56/0.41	0.56/0.41	0.56/0.41	0.56/0.41
(1) = Blank plate (2) = Burner pressure regulator	1 or 2	2	2	2	2	2
Nominal load (gross calorific value)	kW	32.2	52.2	83.3	113.3	127.7
Nominal output	kW	26.4	42.3	67.5	90.8	102.4
Supply pressure	mbar	20	20	20	20	20
Burner pressure (†)	mbar	12.5	12.9	12.9	12.5	14.0
Gas consumption (*)	m^3/h	3.1	5.0	7.9	10.8	12.2
Emissions of Nitrogen Oxides (NO_2)	mg/kWh	248	235	235	246	235
LP gas data						
G30 - 30 mbar (butane)						
Orifice diameter	mm	1.45	1.40	1.50	1.95	n.a.
Diameter of pilot flame orifice	mm	0.25	0.25	0.25	0.25	
(1) = Blank plate (2) = Burner pressure regulator	1 or 2	1	1	1	1	
Nominal load (gross calorific value)	kW	31.4	49.9	81.3	110.5	
Nominal output	kW	26.4	41.4	67.5	90.8	
Supply pressure	mbar	30	30	30	30	
Burner pressure (†)	mbar	-	-	-	-	
Gas consumption (*)	kg/h	2.3	3.6	5.9	8.0	

Description	Unit	BFM 30	BFM 50	BFM 80	BFM 100	BFM 120
LP gas data						
G31 - 37 mbar (propane)						
Orifice diameter	mm	1.45	1.40	1.50	1.95	2.30
Diameter of pilot flame orifice	mm	0.25	0.25	0.25	0.25	0.25
(1) = Blank plate (2) = Burner pressure regulator	1 or 2	1	1	1	1	2
Nominal load (upper value)	kW	30.4	47.8	77.2	110.9	125.0
Nominal output	kW	25.5	39.6	63.9	90.8	102.4
Supply pressure	mbar	37	37	37	37	37
Burner pressure (†)	-	-	-	-	--	22.0
Gas consumption (*)	kg/h	2.2	3.4	5.5	7.9	8.9
(*) Based on 1013.25 mbar and 15 °C.						
(†) If using a blank plate instead of a burner pressure regulator, it is assumed that the burner pressure is equal to the supply pressure. In practice, however, the burner pressure will be lower.						



3.5 Installation diagram

3.5.1 Installation

This figure shows the installation diagram. This diagram is used in the sections in which the actual connection process is described.

Installation diagram

Legend

Only applicable numbers are mentioned.

1. pressure reducing valve (mandatory)
 3. T&P valve
 4. stop valve (recommended)
 5. non-return valve (mandatory)
 6. circulation pump (optional)
 7. top to bottom circulation pump (optional)
 9. drain valve
 10. manual gas valve (mandatory)
 11. service stop valve (mandatory)
 12. temperature gauge (recommended)
 14. hot water draw-off points
 15. expansion valve (mandatory)
 16. expansion vessel (mandatory)
 17. 3-way aeration valve (recommended)
 18. water tank
 19. float valve
- A. cold water supply
 B. hot water supply
 C. circulation pipe
 D. gas supply
 E. overflow pipe
 H. overflow pipe

UNVENTED

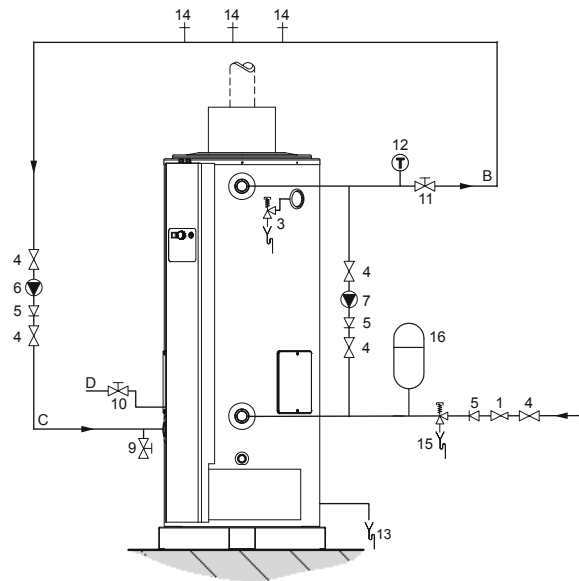

VENTED

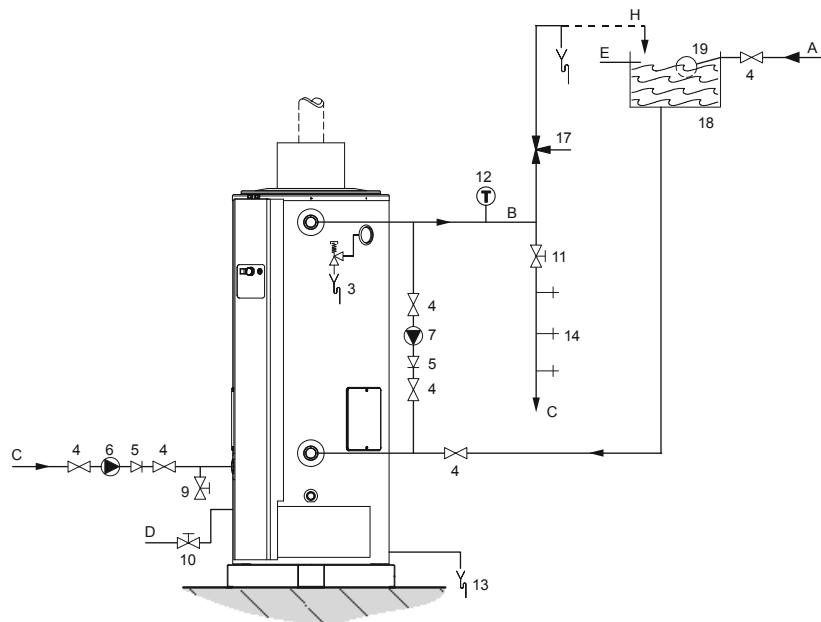

IMD-0467 R0

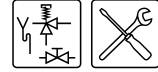

3.6 Water connections, Vented



Warning

The installation should be carried out by an authorised installation engineer, in compliance with general and local regulations (1.3 "Regulations").

3.6.1 Cold water side

See (A) in the installation diagram (3.5 "Installation diagram").

1. Fit an approved stop valve (4) on the cold water side between the cold water head tank (18) and the appliance, as required by regulations (1.3 "Regulations").

3.6.2 Recirculation pipe

You can install a top to bottom circulation pump to prevent water stacking in the boiler.

1. Optional: depending on the draw-off pattern, fit a recirculation pipe (Ø 22 mm), a stop valve (11) and a top to bottom circulation pump (7).
2. Fit a non-return valve (5).
3. Fit a stop valve (11).

3.6.3 Hot water side

See (B) in the installation diagram (3.5 "Installation diagram").



Note

Insulating long hot water pipes prevents unnecessary energy loss.

1. Fit the T&P valve (3).
2. Optional: fit a temperature gauge (12) so you can check the temperature of the tap water.
3. Fit a stop valve (4) in the hot water outlet pipe, for use when servicing.
4. If a circulation pipe is required, continue further by installing the circulation pipe (3.6.5 "Circulation pipe").

3.6.4 Drain valve

1. Fit the standard drain valve (9) supplied with the appliance.
2. If applicable, fit a circulation pipe (3.6.5 "Circulation pipe").
If not, fit the blind threaded plug and gasket (C) supplied with the drain valve, as shown in the figure.

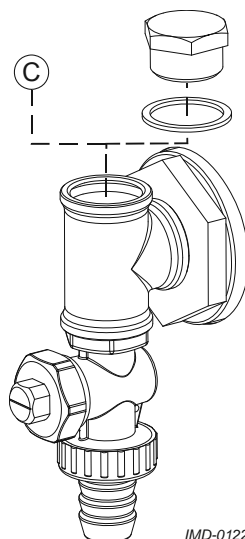

IMD-0122 R1



3.6.5 Circulation pipe

See (C) in the installation diagram (3.5 "Installation diagram").

If an immediate flow of hot water is required at draw-off points, a circulation pump can be installed. This improves comfort and reduces water wastage.

1. Fit a circulation pump (6) of the correct capacity for the length and resistance of the circulation system.
2. Fit a non-return valve (5) behind the circulation pump to guarantee the direction of circulation.
3. Fit two stop valves for service purposes (4).
4. Connect the circulation pipe to the T-piece at the drain valve (9) as shown in the drain valve figure (3.6.4 "Drain valve").

3.7 Water connections, Unvented



Warning

The installation should be carried out by an authorised installation engineer, in compliance with general and local regulations (1.3 "Regulations").

3.7.1 Cold water side

See (A) in the installation diagram (3.5 "Installation diagram").

1. Fit an approved stop valve (4) on the cold water side as required by applicable regulations (1.3 "Regulations").
2. The maximum working pressure of the appliance is 8 bar. Because the pressure in the water pipe at times can exceed 8 bar, you must fit an approved pressure-reducing valve (1).
3. Fit a non-return valve (5) and an expansion vessel (16).
4. Fit an expansion valve (15) and connect the overflow side to an open wastewater pipe.

3.7.2 Recirculation pipe

You can install a top to bottom circulation pump to prevent water stacking in the boiler.

1. Optional: depending on the draw-off pattern, fit a recirculation pipe (Ø 22 mm), a stop valve (11) and a top to bottom circulation pump (7).
2. Fit a non-return valve (5).
3. Fit a stop valve (11).

3.7.3 Hot water side

See (B) in the installation diagram (3.5 "Installation diagram").



Note

Insulating long hot water pipes will prevent unnecessary energy loss.

1. Optional: fit a temperature gauge (12) so you can check the temperature of the tap water.
2. Fit the T&P valve (3).
3. Fit a stop valve (11) in the hot water outlet pipe for servicing.

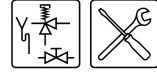

3.7.4 Drain valve

1. Fit the standard drain valve (9) supplied with the appliance.
2. If applicable, fit a circulation pipe (3.6.5 "Circulation pipe").
If not, fit the blind threaded plug and gasket (C) supplied with the drain valve, as shown in the figure.

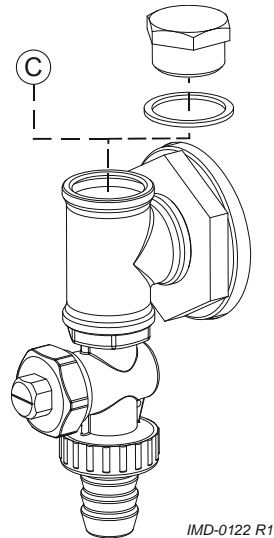

3.7.5 Circulation pipe

See (C) in the installation diagram (3.5 "Installation diagram").

If an immediate flow of hot water is required at draw-off points, a circulation pump can be installed. This improves comfort and reduces water wastage.

1. Fit a circulation pump (6) of the correct capacity for the length and resistance of the circulation system.
2. Fit a non-return valve (5) behind the circulation pump to guarantee the direction of circulation.
3. Fit two stop valves for service purposes (4).
4. Connect the circulation pipe to the T-piece at the drain valve (9) as shown in the drain valve figure (3.6.4 "Drain valve").

3.8 Gas connection

Warning

The installation should be carried out by an authorised installation engineer, in compliance with general and local regulations (1.3 "Regulations").

Caution

Make sure that the diameter and length of the gas supply pipe are large enough to supply sufficient capacity to the appliance.

See (D) in the installation diagram (3.5 "Installation diagram").

1. Fit a manual gas valve (10) in the gas supply pipe.
2. Blow the gas pipe clean before use.
3. Close the manual gas valve.
4. Fit the gas supply pipe to the gas control valve.

Warning

After fitting, check for leaks.

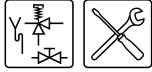

3.9 Air supply and flue

3.9.1 Introduction

Warning

The installation should be carried out by an authorised installation engineer, in compliance with general and local regulations (1.3 "Regulations").

The BFM 30, 50 and 80 differ from the BFM 100 and 120 in how the air supply and chimney flue are connected.

3.9.2 Installing chimney flue components for BFM 30, 50, 80

The BFM-appliances are approved for installation types C13 and C33. The instruction manual describes these types. For a more detailed explanation, please contact your supplier or the manufacturer.

Note

We prescribe the use of a concentric roof or wall flue terminal, exclusively of a type approved for the appliance.

You must fulfil the following requirements:

- The maximum permissible length of chimney pipe (A+B+C) is 7 metres.
- The maximum permissible number of 45° or 90° bends is 2.
- If you are using a horizontal pipe, you must mount it with a minimum run-off of 5 mm per running metre of pipe towards the appliance!
- Make sure that the chimney discharges into an area approved for this type of appliance.

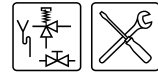

3.9.3 Concentric wall flue terminal BFM 30-50-80

Wall flue terminal

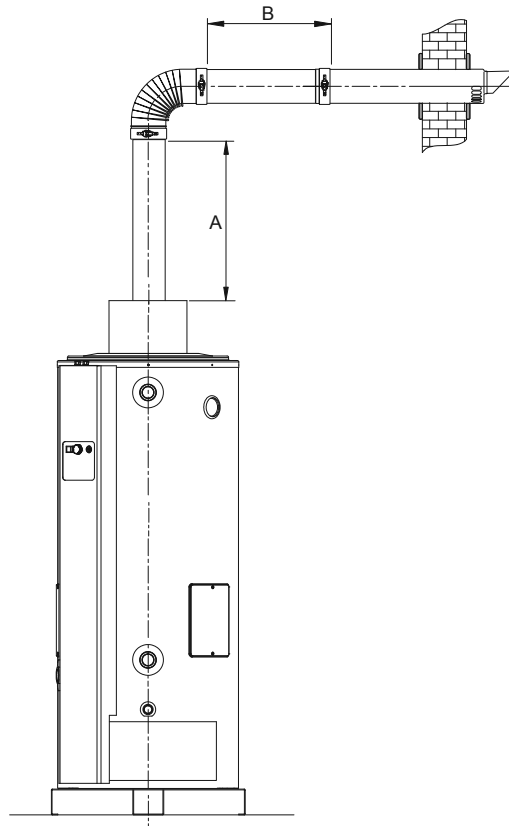

IMD-0060 R2

3.9.4 C13 concentric wall flue terminal specifications (BFM 30, 50, 80)

C13 Concentric wall flue terminal specifications

Subject	Description	
Wall flue terminal set: <ul style="list-style-type: none"> • 1x Wall flue terminal (incl. wall flange & clamping ring) • 1x Pipe 500 mm • 1x Bend 90° 	Art. No.	BFM 30 0302 515 ¹ BFM 50 0302 504 ¹ BFM 80 0302 326 ¹
	Construction	Concentric
	Manufacturer	Muelink & Grol
	Type	M2000 MDV SE WL
Pipe material	Construction	Concentric
	Chimney flue	Thick-walled aluminium with lip ring seal
	Air supply	Thin-walled galvanised sheet steel
Pipe diameters	Chimney flue	BFM 30 Ø 80 mm
		BFM 50 Ø 100 mm
		BFM 80 Ø 130 mm
	Air supply	BFM 30 Ø 125 mm BFM 50 Ø 150 mm BFM 80 Ø 200 mm

(1) No other wall flue terminal is permitted. Order the wall flue terminal set from manufacturer or trade supplier, stating the article number.

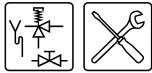

3.9.5 Concentric roof flue terminal BFM 30, 50, 80

Roof flue terminal

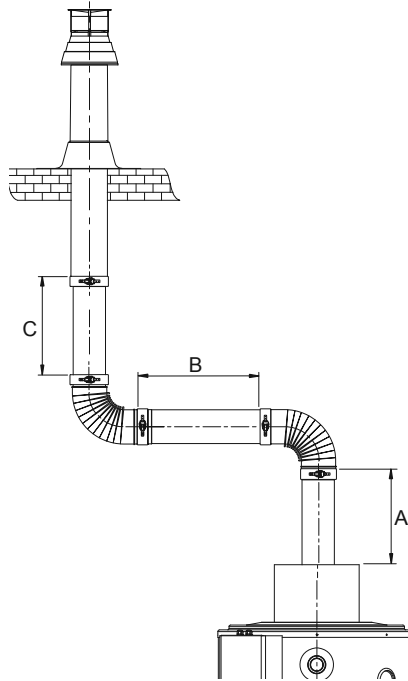

3.9.6 C33 concentric roof flue terminal specifications (BFM 30, 50, 80)

C33 concentric roof flue terminal specifications

Subject		Description	
Roof flue terminal set: <ul style="list-style-type: none"> • 1x Roof flue terminal (incl. clamping ring) • 1x pipe 1000 mm • 1x mounting flange 	Art. No.	BFM 30	0302 518 ¹
		BFM 50	0302 507 ¹
		BFM 80	0302 327 ¹
	Construction	Concentric	
	Manufacturer	Muelink & Grol	
	Type	M2000 DDV SE HR/VR	
Pipe material	Construction	Concentric	
	Chimney flue	Thick-walled aluminium with lip ring seal	
	Air supply	Thin-walled galvanised sheet steel	
Pipe diameters	Chimney flue	BFM 30	Ø 80 mm
		BFM 50	Ø 100 mm
BFM 80		Ø 130 mm	
	Air supply	BFM 30	Ø 125mm
		BFM 50	Ø 150 mm
		BFM 80	Ø 200 mm
(1) No other roof flue terminal is permitted. Order the roof flue terminal set from manufacturer or trade supplier, stating the article number.			

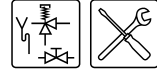

3.9.7 Installing chimney flue components for BFM 100, 120

The air supply duct (1) and chimney flue (2) for the BFM 100 and 120 emerge separately from the top box. They must be connected to the concentric wall flue terminal or roof flue terminal by means of a transition piece.

Parallel connection BFM 100, 120

Legend

- 1. Air supply
- 2. chimney flue

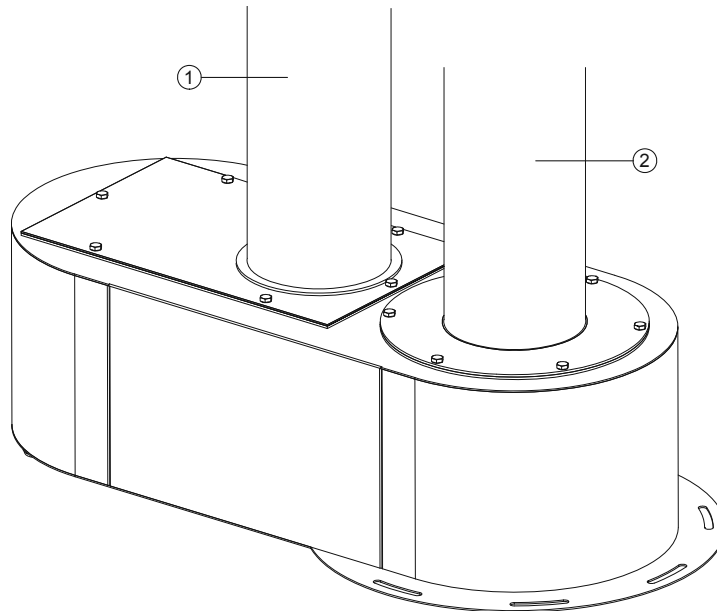

IMD-0252 R1

A.O. Smith prescribes the use of a concentric roof or wall flue terminal, exclusively of a type approved for the appliance. Use of an incorrect roof or wall flue terminal can cause the installation to malfunction.

You must also fulfil the following requirements:

- The maximum permissible length of chimney pipe (A+B+C) is 7 metres.
- The maximum permissible number of 45° or 90° bends is 2.
- If you are using a horizontal pipe, you must mount it with a minimum run-off of 5 mm per running metre of pipe towards the appliance!
- The transition piece to convert the air supply and chimney flue from parallel to concentric must be installed immediately before the wall or roof flue terminal.
- The intake duct of the air supply must be approximately the same as the chimney flue.
- Make sure that the chimney flue discharges into an area approved for this type of appliance.

See the figures. Wall flue terminal ([3.9.8 "Concentric wall flue terminal BFM 100, 120"](#)) and Roof flue terminal ([3.9.10 "Concentric roof flue terminal BFM 100, 120"](#)) for examples of installation.



3.9.8 Concentric wall flue terminal BFM 100, 120

Wall flue terminal

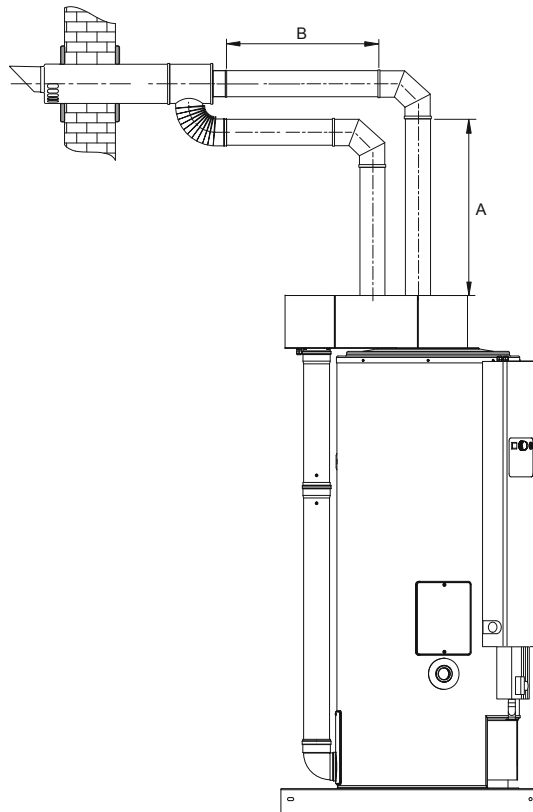

IMD-0226 R1

3.9.9 C13 concentric wall flue terminal specifications (BFM 100, 120)

C13 Concentric wall flue terminal specifications

Subject	Description	
Wall flue terminal set: <ul style="list-style-type: none"> • 1x Wall flue terminal (incl. wall flange & clamping ring) • 1x Clamping ring • 1x Transition piece • 2x Pipe 500 mm • 2x Bend 90° 	Art. No.	0306 774 ¹
	Construction	Concentric
	Manufacturer	Muelink & Grol
	Type	M2000 MDV SCC
Pipe material	Construction	Parallel
	Chimney flue	Thick-walled aluminium with lip ring seal
	Air supply	Thick-walled aluminium with lip ring seal
Pipe diameters	Chimney flue	Ø 130 mm
	Air supply	Ø 130 mm
<i>(1) No other wall flue terminal is permitted. Order the wall flue terminal set from manufacturer or trade supplier, stating the article number.</i>		

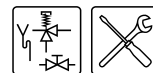

3.9.10 Concentric roof flue terminal BFM 100, 120

Roof flue terminal

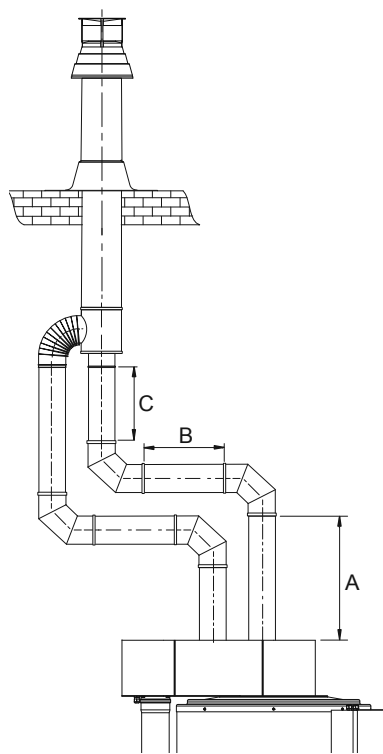

3.9.11 C33 concentric roof flue terminal specifications (BFM 100, 120)

C33 concentric roof flue terminal specifications

Subject	Description	
Roof flue terminal set: • 1x Wall flue terminal (incl. clamping ring) • 1x Pipe 1000 mm • 1x Mounting flange	Art. No.	0306 773 ¹
	Construction	Concentric
	Manufacturer	Muelink & Grol
	Type	M2000 DDV SE
Pipe material	Construction	Parallel
	Chimney flue	Thick-walled aluminium with lip ring seal
	Air supply	Thick-walled aluminium with lip ring seal
Pipe diameters	Chimney flue	Ø 130 mm
	Air supply	Ø 130 mm
<i>(1) No other roof flue terminal is permitted. Order the roof flue terminal set from manufacturer or trade supplier, stating the article number.</i>		



3.10 Electrical connection

Warning

The installation should be carried out by an authorised installation engineer, in compliance with general and local regulations (1.3 "Regulations").

This paragraph describes the electrical connections.

The figure shows a view of the electrical connector block, and the table shows the appropriate connections.

Connector block

Legend

- A. screws
- B. protective cap
- C. connector block

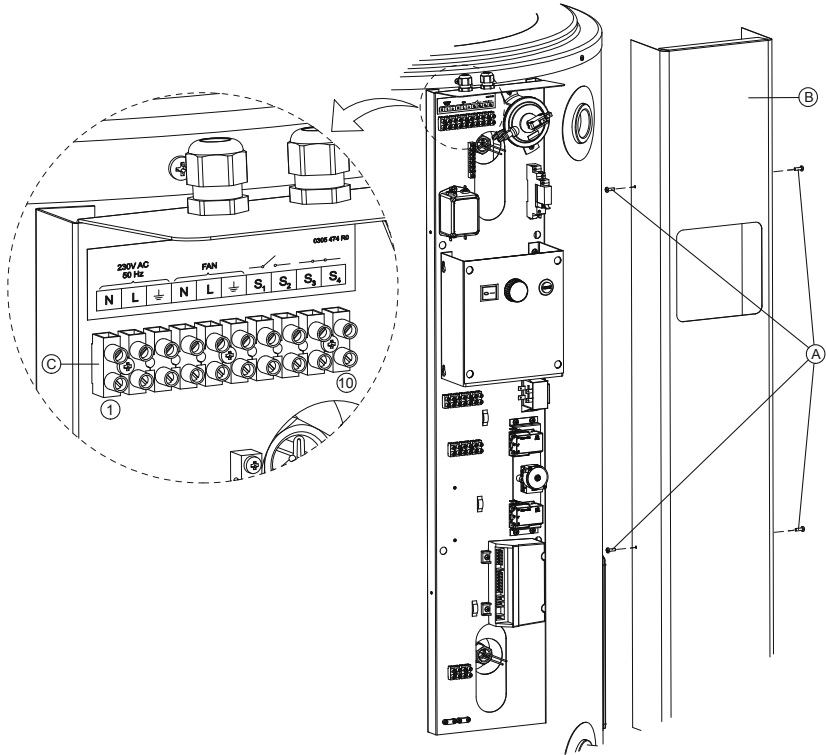

IMD-0243 R1

In preparation you should first remove the two plastic covers and the protective cap of the electrical section.

1. Undo the screws of the plastic covers.
2. Carefully remove the covers from the appliance.
The electrical section is now visible.
3. Loosen the 2 screws (A) of the electrical section, and remove the protective cover (B) from the electrical section.
The connector block (C) is now visible.

Note

Refer to the table for connections 1 through 10.

Consult the electrical diagram (14 "Electrical diagram") for the electrical component connections.

Electrical connector block

Mains power			Fan			Alarm Off			
N	L1	⏚	N	L	⏚	S1	S2	S3	S4
1	2	3	4	5	6	7	8	9	10

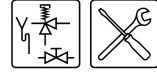

3.10.1 Connecting the mains power

The appliance is supplied without a power cable and isolator.

 **Note**

In order to receive electrical power, the appliance has to be connected to the mains power by means of a permanent electrical connection. A double-pole isolator with a contact gap of at least 3 mm must be fitted between this permanent connection and the appliance. The power cable must have cores of at least 3 x 1.0 mm².

 **Warning**

Leave the appliance isolated until you are ready to start it up.

1. Feed the power cable through the metric strain relief to the top side of the control column.
 2. Connect the earth (\perp), live (L_1) and neutral (N) of the power cable to terminals 1 through 3 in the connector block as stated in the table.
 3. Turn the strain relief tight to clamp the lead.
 4. If you do not need to make any more connections, fit the protective cover onto the control column.
 5. Connect the power cable to the isolator.
-

 **Warning**

Leave the appliance electrically isolated until you are ready to start it up.

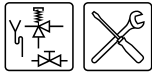

3.11 Checking the supply pressure and burner pressure

Note
Before starting the appliance and/or checking the supply pressure and burner pressure, you must fill (5 "Filling") the appliance.

Caution
Before starting up for the first time or after conversion, you must always check the supply pressure and burner pressure.

Note
The easiest way to check the gas pressures is by using two pressure gauges. This procedure assumes that these two gauges are available.

If the appliance is to be run on a different gas category than the factory preset gas category (see type plate) then you must first convert (4 "Conversion to a different gas category") the appliance.

Gas control valve for BFM 30 through 100

Legend

1. burner pressure regulator
2. burner pressure regulator cap
3. burner pressure regulator adjustment screw
4. gas control valve connector
5. blank plate
6. supply pressure test nipple
7. gas control valve
8. manifold test nipple

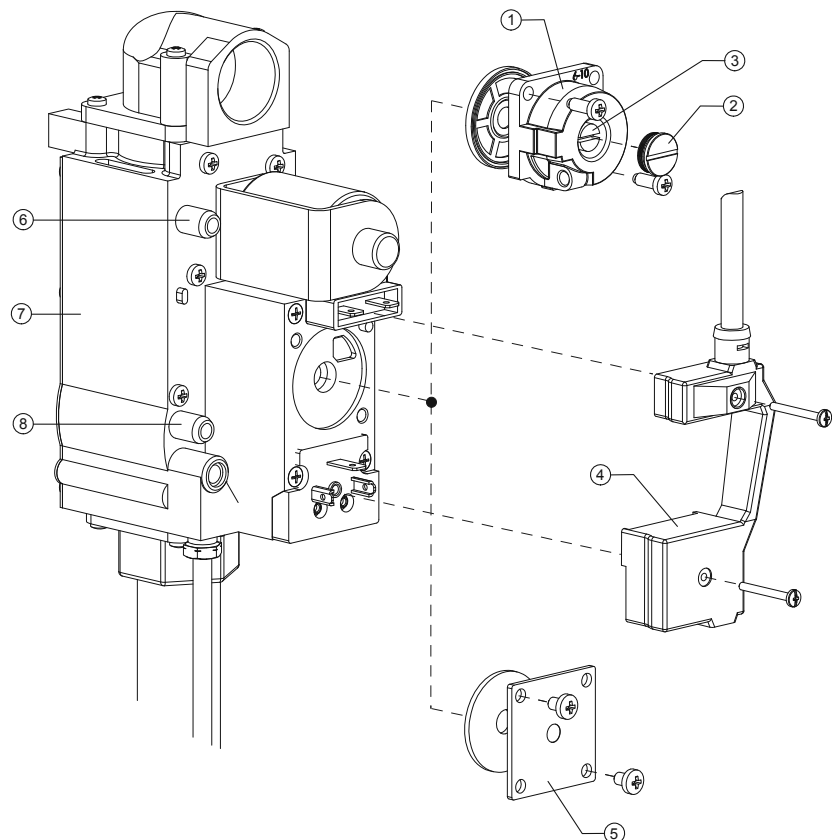

IMD-0256 R1

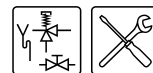

Gas control valve for BFM 120

Legend

1. burner pressure regulator
3. burner pressure regulator adjustment screw
6. supply pressure test nipple
7. gas control valve
8. manifold test nipple

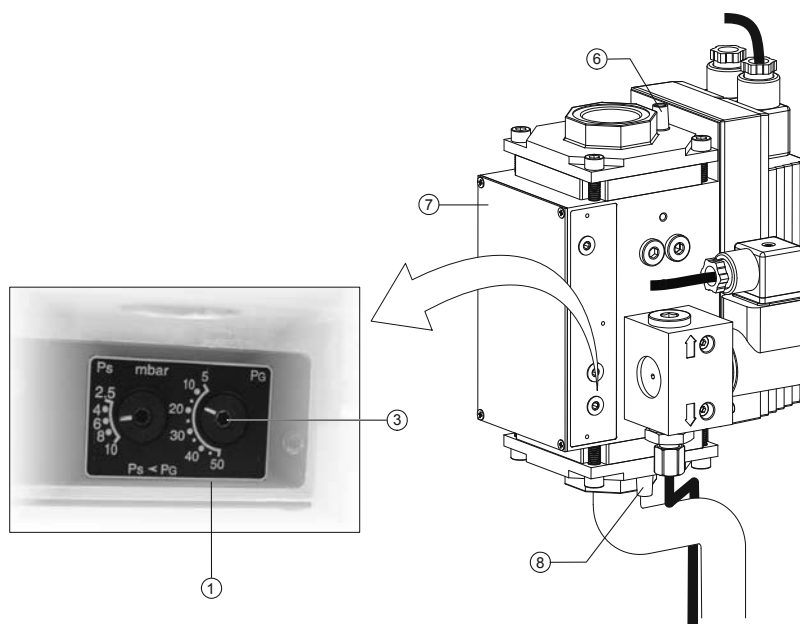

IMD-0257 R1

1. Isolate the appliance from the power supply ([10.3 "Isolating the appliance from the mains"](#)).
2. There are two test nipples on the gas control valve. Test nipple (6) is used to check the supply pressure. The other test nipple on the gas control valve is not used. The manifold test nipple (8) is used to measure the burner pressure.
Sealing screws are located inside the test nipples. Loosen both sealing screws by a few turns. Do not completely loosen them; they can be difficult to re-tighten.
3. Connect a pressure gauge to the manifold test nipple (8).
4. Open the gas supply and bleed the air from the mains gas supply via test nipple (6).
5. Connect a pressure gauge to the manifold test nipple (6) when gas starts to flow from this nipple.
6. Switch on the power to the appliance using the isolator on the appliance.
7. Set the control thermostat to the maximum temperature and start the appliance running by setting the ON/OFF switch to position I.
8. The heating cycle will start, and after a short time the burner tray will ignite.
9. After the burner tray has ignited, wait approximately 1 minute before reading the dynamic pressures.
10. Use the pressure gauge to read the supply pressure at test nipple (6). Refer to the gas data table ([3.4.3 "Gas data"](#)).

**Note**

Consult the mains gas supply company if the supply pressure is not correct.

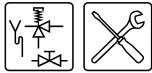

11. Use the pressure gauge to read the burner pressure at nipple (8). Refer to the gas data table (3.4.3 "Gas data").

 **Note**

If the burner pressure is incorrect and the appliance is fitted with a blank plate or high-low control, then you **cannot adjust** the pressure. In this case, consult your installation engineer or supplier. If the appliance is indeed fitted with a burner pressure regulator, then you can adjust the pressure.

BFM 30, 50, 80, 100

12. Remove the cap (2) from the burner pressure regulator.
13. Depending on the correction required, correct the burner pressure by turning adjustment screw (3):
 - Adjustment screw anticlockwise: burner pressure decreases.
 - Adjustment screw clockwise: burner pressure increases.

BFM 120

14. Remove the cap (2) from the burner pressure regulator.
15. Depending on the correction required, correct the burner pressure by turning adjustment screw (3) (PG) using the Allen key supplied with the appliance:
 - Adjustment screw anticlockwise: burner pressure decreases.
 - Adjustment screw clockwise: burner pressure increases.

 **Warning**

Adjustment screw (Ps) adjusts the starting pressure. This need not, and must never be adjusted from the factory preset.

-
16. Check the burner pressure against the value given in the gas table (3.4.3 "Gas data").
 17. If the pressure reading is not correct, repeat the burner pressure adjustment until the correct pressure is obtained.
 18. Shut down the appliance by setting the 0/1 switch to position 0.
 19. Shut off the gas supply.
 20. Disconnect the two pressure gauges and re-tighten the sealing screws in the test nipples.

 **Note**

Before starting-up the appliance, take time to fill in the warranty card supplied with the appliance. This enables us to guarantee the quality of our systems and further enhance our warranty procedure.

Please return this card as soon as possible. Your customer will then receive a warranty certificate with our warranty conditions

3

Installation

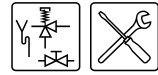



4 Conversion to a different gas category

Caution

The conversion may only be carried out by an authorised installation engineer.

If the appliance must operate on a family of gases (LP gas or natural gas) or other gas category than that for which the appliance has been set at the factory, the appliance will have to be adapted using a special conversion kit.

Caution

You must check the supply pressure and burner pressure once the conversion is complete.

4.1 Conversion

1. Isolate ([10.3 "Isolating the appliance from the mains"](#)) the water heater from the power supply.
 2. Shut off the gas supply.
 3. Referring to the gas table ([3.4.3 "Gas data"](#)), determine whether the pilot flame orifice for the intended gas category is different from the one that is currently fitted. If so, replace ([4.2 "Orifice replacement"](#)) it.
-

Note

The current gas category is stated on the type plate.

4. Referring to the gas table ([3.4.3 "Gas data"](#)), determine whether the main orifice for the intended gas category is different from the one that is currently fitted. If so, replace ([4.2 "Orifice replacement"](#)) it.
5. Referring to the gas table ([3.4.3 "Gas data"](#)), determine whether the use of a blank plate or burner pressure regulator is required for the intended gas category. If this is different than for the current gas category, exchange ([4.3 "Replacement of burner pressure regulator or blank plate BFM 30-50-80-100"](#)) it.
6. Referring to the gas table ([3.4.3 "Gas data"](#)), determine whether the supply pressure and burner pressure for the intended gas category correspond with those for the current gas category, and adjust ([3.11 "Checking the supply pressure and burner pressure"](#)) these if necessary.

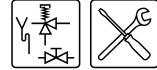

4.2 Orifice replacement

Gas control valve assembly removed

1. strain relief
2. spark electrode lead
3. flame probe lead
4. burner control
5. gas control valve connector(s)
6. gas control valve
7. gas coupling
8. burner tray

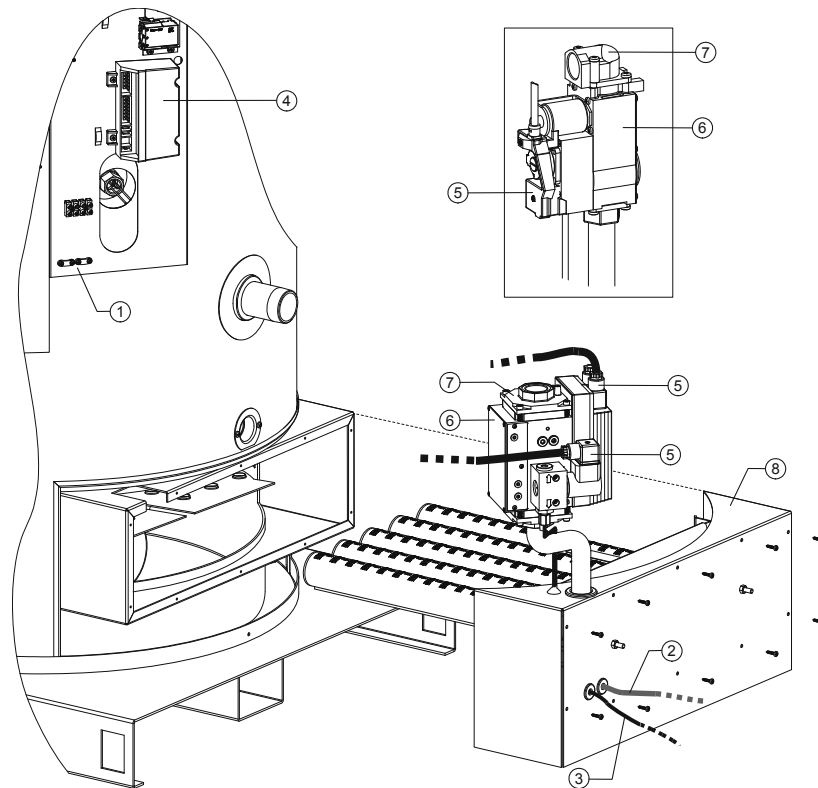

IMD-0254 R1

1. Remove the protective cover from the control column:
undo the 4 screws and remove the protective cover by lifting it. The electrical section will now be exposed.
2. Remove the strain relief (1) and disconnect the leads of the spark electrode (2 = red) and the flame probe (3 = black) from the burner control (4).
3. Unscrew the connector(s) (5) of the gas control valve (6).
4. Remove the gas coupling (7) of the gas control valve.
5. Remove the ten screws that fasten the burner tray (8).
6. Withdraw the burner tray from the appliance.

Note

When exchanging the pilot flame orifice and/or main orifices: Lay the burner tray on its side and approach it from the underside.

7. If the gas table (3.4.3 "Gas data") indicates that the pilot flame orifice needs to be replaced:
 - a. Remove the spark electrode (1) from its retaining clip. This way you will gain space to remove the pilot flame orifice.
 - b. Turn the flame probe (2) and remove it from its bracket to gain space.
 - c. Remove the bracket of the pilot flame orifice (3).
 - d. Replace the current pilot flame orifice (4) with a pilot flame orifice of the correct diameter from the conversion set.
 - e. Check the pilot flame orifice. The orifice diameter is stamped on the orifice itself..
 - f. Re-fit the bracket, the flame probe and the spark electrode.



8. If the gas table ([3.4.3 "Gas data"](#)) indicates that the main burner orifices need to be replaced:
 - a. Remove the main orifices (5).
 - b. Fit the main orifices from the conversion set. Check the required orifice diameter against the value given in the gas table ([3.4.3 "Gas data"](#)). The orifice diameter is stamped on the orifice itself.
9. If necessary, replace the blank plate or burner pressure regulator.
10. Re-fit the burner tray and fasten it using the screws.
11. Fit the gas coupling to the gas control valve and firmly tighten the connector(s) of the gas control valve.
12. Reconnect the leads of the spark electrode and flame probe to the burner control and fasten them in the strain relief.
13. Connect the gas supply.
14. Re-fit the protective cover.

Note

Refer to the electrical diagram ([14 "Electrical diagram"](#)) for correct connection of the electrical components.

4.3 Replacement of burner pressure regulator or blank plate BFM 30-50-80-100

Referring to the gas table, determine whether the gas control valve needs to be fitted with a blank plate or burner pressure regulator. If necessary, replace them as follows:

1. Carry out steps 7 through 9 of orifice replacement ([4.2 "Orifice replacement"](#)).
2. Remove the burner pressure regulator or blank plate from the appliance.
3. Fit the burner pressure regulator or blank plate from the conversion set.
4. Carry out steps 10 through 14 of orifice replacement ([4.2 "Orifice replacement"](#)).

Note

Once you have completed the replacement of the components, you must check the supply pressure and burner pressure to match the intended gas category ([3.11 "Checking the supply pressure and burner pressure"](#)).

4

Conversion to a different gas category

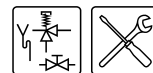

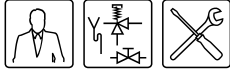

5 Filling

Installation diagram

Legend

Only applicable numbers are mentioned.

1. pressure reducing valve (mandatory)
3. T&P valve
4. stop valve (recommended)
5. non-return valve (mandatory)
6. circulation pump (optional)
7. top to bottom circulation pump (optional)
9. drain valve
10. manual gas valve (mandatory)
11. service stop valve (mandatory)
12. temperature gauge (recommended)
14. hot water draw-off points
15. expansion valve (mandatory)
16. expansion vessel (mandatory)
17. 3-way aeration valve (recommended)
18. water tank
19. float valve
- A. cold water supply
- B. hot water supply
- C. circulation pipe
- D. gas supply
- E. overflow pipe
- H. overflow pipe

UNVENTED

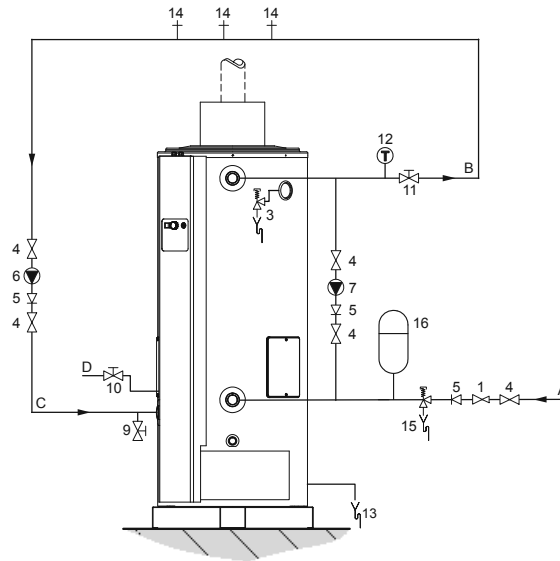

VENTED

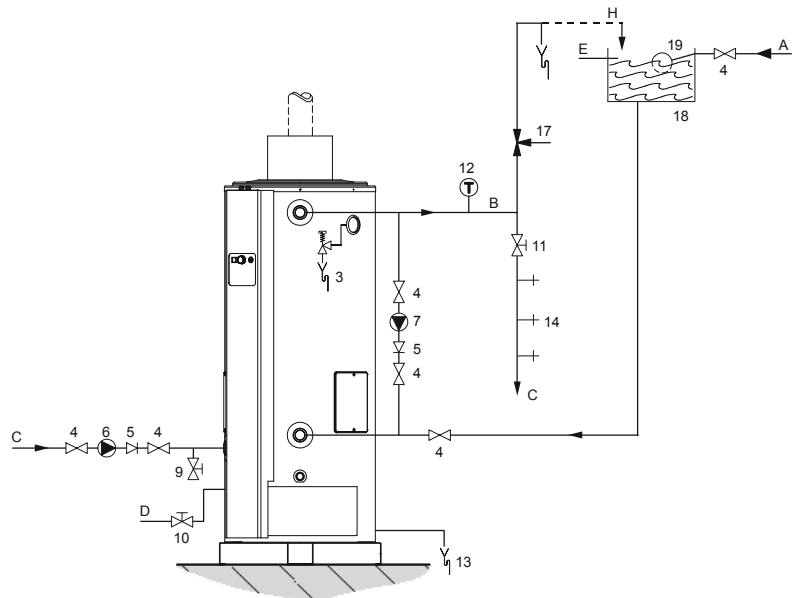

IMD-0467 R0

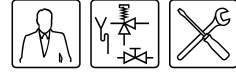

5.1 Filling unvented installations

To fill the appliance, proceed as follows:

1. Open the stop valve (11) in the hot water pipe and, if present, the stop valves (4) for the circulation pump (6).
2. Close the drain valve (9).
3. Open the nearest hot water draw-off point (14).
4. Open the stop valve (4) on the cold water side (A) so that cold water flows into the appliance.
5. Completely fill the appliance. When a full water jet flows from the nearest draw-off point, the appliance is full.
6. Bleed the entire installation of air, for example by opening all draw-off points.
7. The appliance is now under water supply pressure. There should be no water coming out of the expansion valve (15) or out of the T&P valve (3). If there is, the cause might be:
 - The T&P valve is defective or incorrectly fitted.
 - The water supply pressure is greater than the specified 8 bar. Rectify this by fitting a pressure reducing valve (1).
 - The expansion valve in the protected cold supply setup is defective or incorrectly fitted.

5.2 Filling vented installations

To fill the appliance, proceed as follows:

1. Open the stop valve (11) in the hot water pipe and, if present, the stop valves (4) for the circulation pump (6).
2. Close the drain valve (9).
3. Open the nearest hot water draw-off point (14).
4. Open the stop valve (4) on the cold water side (A) so that cold water flows into the appliance.
5. Completely fill the appliance. When a full water jet flows from the nearest draw-off point, the appliance is full.
6. Bleed the entire installation of air, for example by opening all draw-off points.
7. The appliance is now under water supply pressure. There should be no water coming out of the T&P valve (3). If this does happen, the T&P valve might be defective or incorrectly fitted.

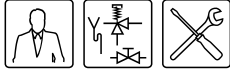

6 Draining

Installation diagram

Legend

Only applicable numbers are mentioned.

1. pressure reducing valve (mandatory)
 3. T&P valve
 4. stop valve (recommended)
 5. non-return valve (mandatory)
 6. circulation pump (optional)
 7. top to bottom circulation pump (optional)
 9. drain valve
 10. manual gas valve (mandatory)
 11. service stop valve (mandatory)
 12. temperature gauge (recommended)
 14. hot water draw-off points
 15. expansion valve (mandatory)
 16. expansion vessel (mandatory)
 17. 3-way aeration valve (recommended)
 18. water tank
 19. float valve
- A. cold water supply
 B. hot water supply
 C. circulation pipe
 D. gas supply
 E. overflow pipe
 H. overflow pipe

UNVENTED

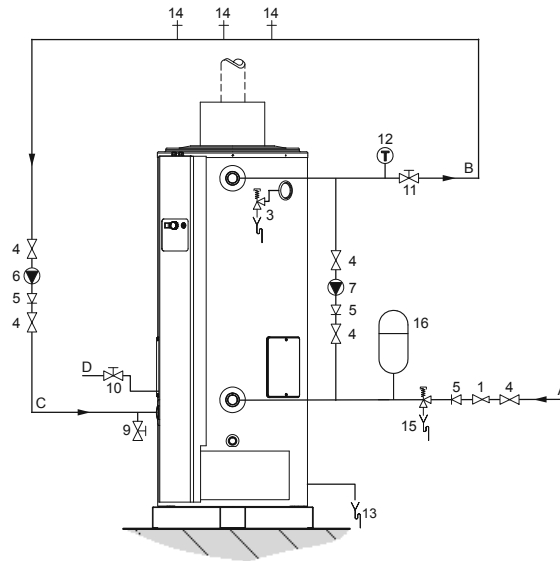

VENTED

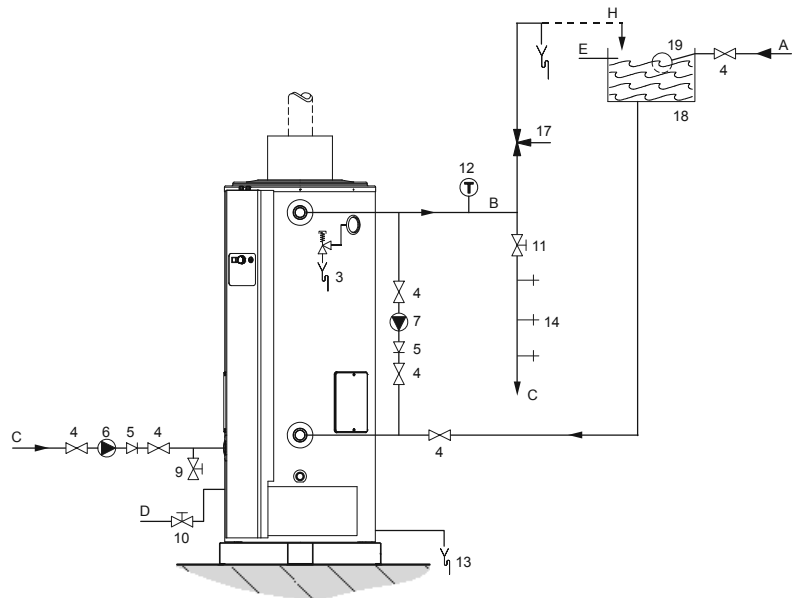

IMD-0467 R0

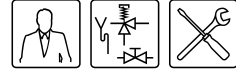

6.1 Draining unvented installations

Some service activities require the appliance to be drained. The procedure is as follows:

1. Shut down the appliance by setting the ON/OFF switch on the control panel to **position 0**.
2. Isolate the water heater from the power supply by putting the isolator between the appliance and the mains power supply to position 0.
3. Shut off the gas supply (10).
4. Close the stop valve (11) in the hot water pipe.
5. Close the supply valve of the cold water supply (A).
6. Open the drain valve (9).
7. Bleed the appliance (or installation) so that it drains completely.

6.2 Draining vented installations

Some service activities require the appliance to be drained. The procedure is as follows:

1. Shut down the appliance by setting the ON/OFF switch on the control panel to **position 0**.
2. Isolate the water heater from the power supply by putting the isolator between the appliance and the mains power supply to position 0.
3. Shut off the gas supply (10).
4. Close the stop valve (11) in the hot water pipe.
5. Close the stop valve (4) between the cold water head tank and the cold water inlet.
6. Open the drain valve (9).
7. Bleed the appliance (or installation) so that it drains completely.

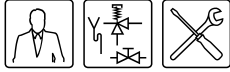

7 The control panel

7.1 Introduction

Topics covered in this chapter:

- [Control panel](#);
- [Explanation of icons](#);
- [ON/OFF switch](#);
- [Control thermostat](#);
- [Burner control reset button](#).

7.2 Control panel



The control panel comprises:

- an ON/OFF switch with status lamp;
- a reset button with status lamp;
- a control thermostat with rotary knob;
- two status lamps.

7.3 Explanation of icons

The table explains the meanings of the icons.

Icons and their meaning

	Name	Explanation
	ON/OFF Switch	ON mode / OFF mode
	Reset button with error status	Resets burner control
	Temperature control	For setting water temperature (Tset)

7.4 ON/OFF switch

The ON/OFF switch sets the appliance in ON mode or OFF mode. In OFF mode the appliance is still electrically live. This ensures that the frost protection is active.



Note

To electrically isolate the appliance, you must use the isolator between the appliance and the mains power supply.

7.5 Control thermostat

Use the rotary knob of the control thermostat to set the desired water temperature between $\pm 40\text{ °C}$ and $\pm 70\text{ °C}$. The range is continuous and is labeled 1 through 4. The table shows the temperatures corresponding to the numbers on the knob.

Temperature settings

Position	Temperature
1	$\pm 40\text{ °C}$
2	$\pm 50\text{ °C}$
3	$\pm 60\text{ °C}$
4	$\pm 70\text{ °C}$

7.6 Burner control reset button

An error in the appliance can cause a lockout of the burner control. When this happens, the reset button lamp will be lit. Once the cause of the error has been rectified, you can reset the appliance using the reset button.



Note

Never use the reset button until you have rectified the error.

Many errors (11 "Troubleshooting") can be identified according to the appliance status (8 "Status of the appliance").

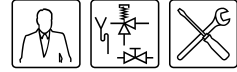

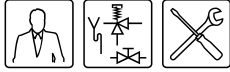

8 Status of the appliance

8.1 Introduction

Topics covered in this chapter:

- [Operating modes](#);
- [Error conditions](#);

8.2 Operating modes

When running, the appliance has three basic operating modes, namely:

- **ELECTRICALLY ISOLATED**

In this mode, the appliance is off and no components are live. The isolator (switch between the appliance and the mains power supply) is off. On the control panel:

- the ON/OFF switch is at position 0;
- the green light is dimmed.

- **OFF**

In this mode, the frost protection is activated. The isolator is at position I. On the control panel:

- the ON/OFF switch is at position 0;
- the green light is lit.

- **ON**

In this mode, the appliance continuously responds to the heat demand. On the control panel:

- the ON/OFF switch is at position I;
- the water temperature can be set using the rotary knob of the control thermostat ([7.5 "Control thermostat"](#));
- the green light is lit.

8.3 Error conditions

When the appliance is in an error condition, the heat demand is (temporarily) ignored, and you cannot draw hot water. The frost protection is also out of action.

The error conditions are divided into three groups:

- **Lock out errors of the burner control**

In this event, the red error light will be lit in the reset button on the control panel. The burner control is in lockout.

Once the cause has been rectified, the reset button must be pressed to restart the appliance.

- **Cycling of appliance**

In this case, the appliance continuously attempts to start, but there is an error that prevents the heating cycle from completing successfully.

Once the cause has been rectified, the appliance will restart automatically.

- **Blocking errors**

You can recognize this condition when the appliance makes no attempt to start the heating cycle, despite the fact that the water is colder than the temperature set with the control thermostat ([7.5 "Control thermostat"](#)). These errors disappear automatically once the cause of the error has been removed, after which the appliance resumes operation by itself.

The cause of the error is not shown on the control panel. For a comprehensive overview of errors, refer to troubleshooting. ([11 "Troubleshooting"](#))

As an end user, if you find the appliance in an error condition, you can attempt to start the appliance running by pressing the rest button once. However, if the error returns or occurs several times in a short time, you must contact your service and maintenance engineer.

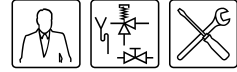

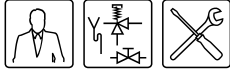

9 Starting and running

9.1 Introduction

Topics covered in this chapter:

- [Starting the appliance](#);
- [The appliance's heating cycle](#).

9.2 Starting the appliance

Start the appliance as follows:

1. Fill the appliance ([5 "Filling"](#)).
2. Open ([3.5 "Installation diagram"](#)) the manual gas valve.
3. Switch on the power to the appliance using the isolator between the appliance and the power supply.
4. Put the appliance in ON mode by setting the ON/OFF switch on the control panel to **position I**.
5. Using the control thermostat ([7.5 "Control thermostat"](#)), set the desired water temperature.

If there is a heat demand, the appliance will run through the heating cycle ([9.3 "The appliance's heating cycle"](#)).

9.3 The appliance's heating cycle

The appliance's heating cycle is activated as soon as the measured water temperature (T_{water}) falls below the threshold value (T_{set}). This threshold value depends on the currently selected appliance operating mode. For example, if the appliance is in OFF mode (frost protection), then this value is 20 °C. If the appliance is in ON mode, for example, then this threshold value can be selected, e.g. position 3 (± 60 °C).

The heating cycle runs successively through the following states:

1. HEAT DEMAND;
2. WAIT;
3. PRE-GLOW;
4. IGNITION;
5. RUNNING;
6. WAIT.

The entire cycle is explained in the example below.

Note

The cycle has the same steps when frost protection is activated.

1. The control thermostat sensor measures the temperature. The water temperature falls below the set temperature of (for example) 60 °C, causing the control thermostat to close. The burner control now detects a demand and starts the heating cycle.
2. Following demand, the wait period starts. This wait ensures that the ignition is safe. The wait period lasts approximately 15 seconds.
3. Once the wait period has elapsed (there is audible 'clicking' of the relay in the burner control), the PRE-GLOW starts.
4. After about 12 seconds (pre)glowing, the gas control valve opens and ignition takes place.
5. After ignition, the flame is detected and the appliance will be running. This means that actual heating has started.
6. When the water reaches the set temperature, the demand ceases. The gas control valve closes and the burner tray is extinguished. A new wait period of about 10 seconds starts.
7. At the end of this wait, the appliance enters the idle state, and waits until the water temperature once more falls below the set temperature.

With any subsequent heat demand, the heating cycle will resume from step 1.

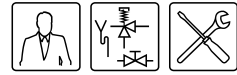

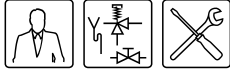

10 Shutting down

10.1 Introduction

Topics covered in this chapter:

- Shutting down the appliance for a brief period (OFF mode);
- Isolating the appliance from the mains;
- Shutting the appliance down for a long period;
- Disposal.

10.2 Shutting down the appliance for a brief period (OFF mode)

To shut the appliance down for a brief period, you must activate frost protection using the appliance's heating cycle (2.3 "The appliance's heating cycle").

By using the frost protection, you can prevent water freezing in the appliance. Frost protection is activated by setting the ON/OFF switch on the control panel to position 0.

10.3 Isolating the appliance from the mains

The appliance should only be isolated from mains power in the correct way. The correct procedure is as follows:

1. Shut down the appliance by setting the ON/OFF switch to position 0.
2. Isolate the water heater from the power supply by putting the isolator between the appliance and the mains power supply to position 0.

10.4 Shutting the appliance down for a long period

To shut the appliance down for a longer period, you must drain the appliance (6 "Draining").

10.5 Disposal

Old end-of-life appliances contain materials that need to be recycled. When disposing of old devices that have reached the end of their service life, you should take account of local legislation relating to waste disposal.

You must therefore never dispose of your old appliance together with regular waste, but should and it into a municipal waste collection depot for electrical and electronic equipment. Ask your dealer/installation engineer for advice if necessary. The old appliance must be stored out of reach of children.



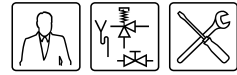

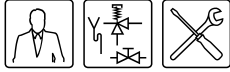

11 Troubleshooting

11.1 Introduction

This chapter deals with the following problems with the appliance:

- Gas smell.
- Water leakage.
- Explosive ignition.
- Poor flame profile.
- No hot water.
- Insufficient hot water.

When the appliance is in an error condition, the heat demand is (temporarily) ignored, and you cannot draw hot water. The frost protection is also out of action. The error conditions are divided into three groups:

- **Lock out errors of the burner control**

In this event, the red error light will be lit on the control panel. The burner control is in lockout.

Once the cause has been rectified, the reset button must be pressed to restart the appliance.

- **Cycling of appliance**

In this case, the appliance continuously attempts to start, but there is an error that prevents the heating cycle (9.3 "The appliance's heating cycle") from completing successfully. Once the cause has been rectified, the appliance will restart automatically.

- **Blocking errors**

You can recognize this condition when the appliance does not start running, despite the fact that the water is colder than the temperature set with the control thermostat (7.5 "Control thermostat").

These errors disappear automatically once the cause of the error has been removed, after which the appliance resumes operation by itself.

Possible error conditions are explained in the following troubleshooting tables.

 **Note**





Footnotes referred to in the tables can be found on the last page of each table.



11.2 Troubleshooting: general errors

 **Warning**
Maintenance may only be performed by a qualified service and maintenance engineer.

General errors

Symptom	Cause	Solution	Remark
Gas smell	Gas leak	 Warning Close the main gas valve immediately.	 Warning Contact your installation engineer or local gas company immediately.
		 Warning Do not operate any switches.	
		 Warning No naked flames.	
		 Warning Ventilate the boiler room.	
Water leakage	Leakage from a water connection (threaded)	Tighten the threaded connection	If the leak persists, consult your installation engineer
	Leakage from another nearby water appliance or pipe segment	Trace the leak	
	Leakage from the appliance's tank	Consult the supplier and/or manufacturer	
	Condensation	Before drawing (too much) tap water, wait until the water in the boiler has reached the set temperature.	
Explosive ignition Poor flame profile	Incorrect supply pressure and/or burner pressure	Set the correct supply pressure and/or burner pressure. (3.11 " Checking the supply pressure and burner pressure ")	If ignition is not improved, consult your installation engineer.
	Contaminated burner	Clean the burner(s) (12.4.2 "Clean the burner(s)")	
	Contaminated orifice	Clean the orifice(s) (12.4.3 "Clean the orifice(s)")	
	Inadequate air supply	Improve the air supply by providing better ventilation in the boiler room.	

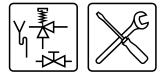

11.3 Troubleshooting: insufficient hot water

Warning
Maintenance may only be performed by a qualified service and maintenance engineer.

Insufficient hot water

Symptom	Cause	Solution	Remark
Insufficient hot water	Water temperature setting (T_{set}) is too low	Set the control thermostat (<u>7.5 "Control thermostat"</u>) to a higher value	
	Hot water supply is used up	<ol style="list-style-type: none"> 1. Reduce hot water consumption and give the appliance time to heat up. 2. If this error persists, check whether the high-limit thermostat is switching. If this is the case, check that the circulation and/or top to bottom circulation pump are working. 	If this error persists, check whether the high-limit thermostat is switching.

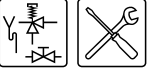

11.4 Troubleshooting: No hot water

No hot water

Symptom	Cause	Solution	Remark
No attempt to start heating cycle	No supply voltage present	<ol style="list-style-type: none"> 1. Check if the isolator is ON. 2. Check whether there is power to the isolator 3. Check whether there is power to the electrical connector block 4. Check whether there is power to the burner control 5. Check fuse in the burner control <p>The measured voltage must be 230 VAC (-15%, +10%).</p>	See the BFM electrical diagram (14 "Electrical diagram") If the error cannot be rectified, contact your installation engineer
No attempt to start heating cycle (blocking error)	Pressure switch not closing	<ol style="list-style-type: none"> 1. Blockage in the chimney flue or air supply <ul style="list-style-type: none"> - Trace the blockage - Remove the blockage 2. Defective pressure switch <ul style="list-style-type: none"> - Check the wiring of the pressure switch - Check that the pressure switch is working 	Once the error is rectified, the appliance will automatically start up if there is a heat demand If the error cannot be resolved or is persistent, contact your installation engineer
	Failure in the thermostat circuit	<ol style="list-style-type: none"> 1. Check whether the control thermostat is switched (closed) 2. Check leads and sensors of the control and high-limit thermostats 	
Repetitive starting of the heating cycle (cycling of the appliance)	Too much resistance in the chimney flue (the pressure switch opens during heating)	<ol style="list-style-type: none"> 1. Check whether the chimney flue configuration (3.9 "Air supply and flue") has been installed in accordance with instructions 	If the error cannot be resolved or is persistent, contact your installation engineer

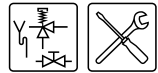

Symptom	Cause	Solution	Remark	
Burner control reset button (burner control lock out error)	There are three possible causes for this error. In order to determine the cause, you must cause the error to appear again:	<ol style="list-style-type: none"> 1. Reset the appliance by pressing the reset button 1x 2. Cause (a) occurs between step 4 and step 5 of the heating cycle 3. Cause (b) occurs in step 5 or 6 4. Cause (c) occurs in step 7 	see the appliance's heating cycle (9.3 "The appliance's heating cycle")	
	(a) Continuous failure in the safety circuit	<ol style="list-style-type: none"> 1. Check whether the thermostat is defective 2. Check whether the sensor of the thermostat is defective 3. Check the leads of the thermostat 	If the error cannot be resolved or is persistent, contact your installation engineer	
	(b) Failed start attempt	No gas:	<ol style="list-style-type: none"> 1. Check that the gas valve is open 2. Check whether the gas control valve is opening (clicking of the gas control valve) 3. Check the leads of the gas control valve 	If the error cannot be resolved or is persistent, contact your installation engineer
		No ignition:	<ol style="list-style-type: none"> 1. Check whether the spark igniter is sparking in the pilot flame cap 2. Check the leads of the glow igniter 3. Check whether the spark igniter is correctly mounted in the bracket 	
		No flame detection:	<ol style="list-style-type: none"> 1. Check whether the flame probe is defective 2. Check that the flame probe leads are properly connected 	
(c) Failure in the safety circuit during heating (the safety thermostat has switched)	<ol style="list-style-type: none"> 1. Check whether the control thermostat is working 2. Check whether the high-limit thermostat is working 3. Check that the circulation pump (if present) is working 	If the error cannot be resolved or is persistent, contact your installation engineer		

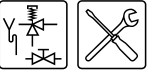



12 Performing maintenance

12.1 Introduction

Caution

Maintenance may only be carried out by an approved service and maintenance engineer.

At each service, the appliance undergoes maintenance on both the water side and the gas side. The maintenance must be carried out in the following order.

1. Water-side maintenance
2. Water-side maintenance
3. Gas-side maintenance
4. Finalising maintenance

Note

Before ordering spare parts, it is important to write down the appliance type and model, and the full serial number of the appliance. These details can be found on the rating plate. Only by ordering with this information can you be sure to receive the correct spare parts.

12.2 Preparation for maintenance

To test whether all components are still working properly, complete the following steps:

1. Set the ON/OFF switch on the control panel to **position 0**.
2. Set the control thermostat to the highest value (note the original setting) and set the ON/OFF switch back again to **position I**.
3. If there is no heat demand, draw off some water to create a heat demand.
4. Check whether the heating cycle (9.3 "The appliance's heating cycle") runs correctly.
5. Set the control thermostat back to the original setting and set the ON/OFF switch back again to **position I**.
6. Check the supply and burner pressure (3.11 "Checking the supply pressure and burner pressure"), and adjust them if necessary.
7. Check that all components of the chimney flue system are properly attached.
8. Test the operation of the overflow valve of the protected cold supply set-up. The water should spurt out.
9. Test the overflow operation of the T&P valve. The water should spurt out.
10. Test the overflow operation of the T&P valve. The water should spurt out with a strong jet.
11. Check the drainpipes from the discharge points of all valves and remove any scale deposits that may be present.
12. Drain the appliance (6 "Draining").



12.3 Water-side maintenance

12.3.1 Introduction

The following steps must be carried out on the water side:

1. Checking the anodes.
2. Descaling and cleaning the tank.

12.3.2 Checking the anodes

Timely replacement of the anodes extends the service life of the appliance. The appliance's anodes must be replaced as soon as they are 60% or more used up (take this into consideration when determining the maintenance frequency).

1. Remove the chimney flue components from the top box.
2. Remove the cover from the top box.
3. Disconnect the fan leads and withdraw the cable through the strain relief.
4. Undo the screws in the top box.
5. Remove the top box from the appliance.
6. Undo the screws of the lid in the top side of the appliance.
7. Remove the lid from the appliance.
8. Remove the sealing ring from the appliance.
9. Loosen the anodes using suitable tools.
10. Check the anodes, and if necessary, replace them.
11. Now also check the flue baffles (12.4.4 "Checking the flue baffles"). If necessary, replace them.
12. Place a new sealing ring on the rim of the tank and re-fit the lid.
13. Fit: the top box.
14. Feed the fan cable through the strain relief and connect the leads to the fan. See addendum (14 "Electrical diagram").
15. Fit: the cover onto the top box.



12.3.3 Descaling and cleaning the tank

Scale and lime buildup prevent effective conduction of the heat to the water. Periodic cleaning and descaling prevents buildup of these deposits. This increases the service life of the appliance, and also improves the heating process.

Take the rate of scale formation into account when deciding on maintenance frequency. Scale formation depends on the local water composition, the water consumption and the water temperature setting. A water temperature setting of maximum 60 °C is recommended for prevention of excessive scale buildup.

To ensure the perfectly watertight sealing of a cleaning opening, the gasket (6), O-ring (7), sealing rings (4), bolts (3) and possibly the lid (5) should be replaced with new components after opening (see the figure). A special set is obtainable from the supplier/manufacturer.

To simplify the task of descaling and cleaning the tank, the appliance is equipped with two cleaning openings.

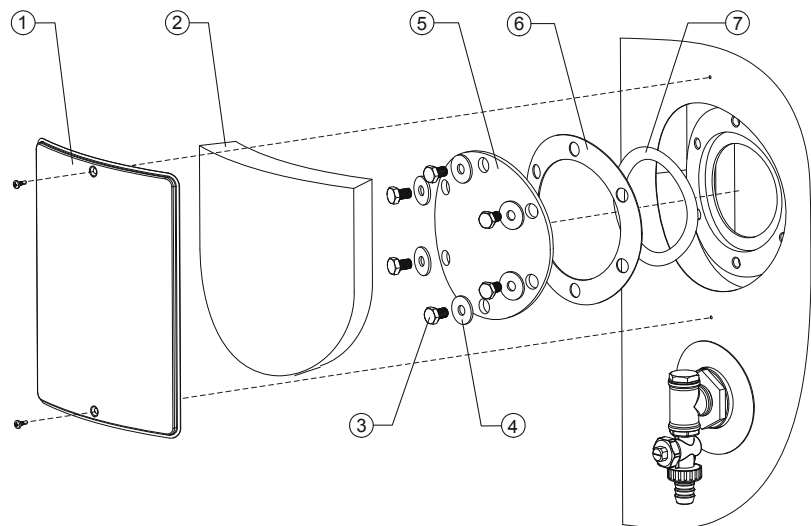

IMD-0235 R2

1. Remove the cover plate (1) on the outer jacket (see the figure).
2. Carefully remove the insulation layer (2) and set it to one side. This will be needed again later.
3. Undo the bolts.
4. Remove the lid, the gasket and the O-ring.
5. Inspect the tank and remove the loose scale deposits and contamination.
6. If the scale cannot be removed by hand, descale the appliance with a descaling agent. Contact the supplier/manufacturer for advice on what descaling agent to use.

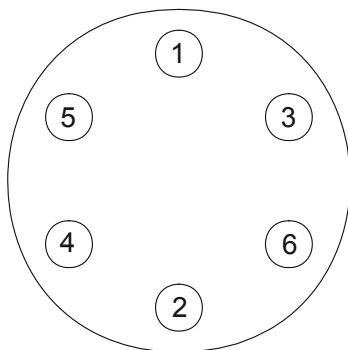

IMD-0282 R1

7. Close the cleaning opening. To avoid damage to the tank, tighten the bolts that fasten the lid with a torque no greater than 50 Nm. Use suitable tools for this. For the best possible watertight seal of the cleaning opening, the bolts in the lid should be torqued down in the sequence shown in the figure.

12.4 Gas-side maintenance

12.4.1 Introduction

The following steps must be carried out on the gas side:

1. Clean the burner(s).
2. Clean the orifice(s).
3. Checking the flue baffles.

12.4.2 Clean the burner(s)

1. Detach the burner(s)
2. Remove all contamination present on the burner(s).
3. Fit the burner(s)

12.4.3 Clean the orifice(s)

1. Detach the orifice(s)
2. Remove all contamination present in the orifice(s).
3. Fit the orifice(s)

12.4.4 Checking the flue baffles



Warning

The flue baffles can be hot.

1. Remove the flue baffles from the appliance.
2. Check the flue baffles for the presence of corrosion, removing this if necessary.
3. Check the flue baffles for wear, and replace the flue baffles if necessary.

12.5 Finalising maintenance

To finalise the maintenance, carry out the following steps:

1. Fill the appliance (5 "Filling").
2. Start the appliance (9 "Starting and running").

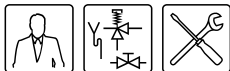

13 Warranty (certificate)

To register your warranty, you should complete and return the enclosed warranty card after which a warranty certificate will be sent to you. This certificate gives the owner of a appliance supplied by A.O. Smith water Products Company B.V. of Veldhoven, The Netherlands (hereinafter "A.O. Smith") the right to the warranty set out below, defining the commitments of A.O. Smith to the owner.

13.1 General warranty

If within one year of the original installation date of a water heater supplied by A.O. Smith, following verification, and at the sole discretion of A.O. Smith, a section or part (with exclusion of the tank) proves to be defective or fails to function correctly due to manufacturing and/or material defects, then A.O. Smith shall repair or replace this section or part.

13.2 Tank warranty

If within 3 years of the original installation date of a water heater supplied by A.O. Smith, following inspection, and at the sole discretion of A.O. Smith, the glass-lined steel tank proves to be leaking due to rust or corrosion occurring on the water side, then A.O. Smith shall offer to replace the defective water heater with an entirely new water heater of equivalent size and quality. The warranty period given on the replacement water heater shall be equal to the remaining warranty period of the original water heater that was supplied. Notwithstanding that stated earlier in this article, in the event that unfiltered or softened water is used, or allowed to stand in the water heater, the warranty shall be reduced to one year from the original installation date.

13.3 Conditions for Installation and use

The warranty set out in article 1 and 2 will apply solely under the following conditions:

- a. The water heater is installed under strict adherence to A.O. Smith installation instructions for the specific model, and the relevant government and local authority installation and building codes, rules and regulations in force at the time of installation.
- b. The water heater remains installed at the original site of installation.
- c. The appliance is exclusively used with drinking water, which at all times can freely circulate (a separately installed heat exchanger is mandatory for heating salt water or corrosive water).
- d. The tank is safeguarded against harmful scaling and lime buildup by means of periodic maintenance.
- e. The water temperatures in the heater do not exceed the maximum setting of the thermostats, which form a part of the water heater.
- f. The water pressure and/or heat load do not exceed the maximum values stated on the water heater rating plate.
- g. The water heater is installed in a non-corrosive atmosphere or environment.
- h. The water heater is connected to a protected cold supply arrangement, which is: approved by the relevant authority; with sufficient capacity for this purpose; supplying a pressure no greater than the working pressure stated on the water heater; and where applicable by a likewise approved temperature and pressure relief valve, fitted in accordance with installation instructions of A.O. Smith applying to the specific model of water heater, and further in compliance with the government and local authority installation and building codes, rules and regulations.
- i. The appliance is at all times fitted with cathodic protection. If sacrificial anodes are used for this, these must be replaced and renewed when, and as soon as, they are 60% or more consumed. When electric anodes are used, it is important to ensure that they continue to work properly.

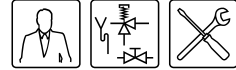

13.4 Exclusions

The warranty set out in articles 1 and 2 will not apply in the event of:

- a. damage to the water heater caused by an external factor;
- b. misuse, neglect (including frost damage), modification, incorrect and/or unauthorised use of the water heater and any attempt to repair leaks;
- c. contaminants or other substances having been allowed to enter the tank;
- d. the conductivity of the water being less than 125 $\mu\text{S}/\text{cm}$ and/or the hardness (alkaline-earth ions) of the water being less than 1.00 mmol/litre (3.3.3 "Water composition");
- e. unfiltered, recirculated water flowing through or being stored in the water heater;
- f. any attempts at repair to a defective water heater other than by an approved service engineer.

13.5 Scope of the warranty

The obligations of A.O. Smith pursuant to the specified warranty do not extend beyond free delivery from the Veldhoven warehouse of the replacement sections, parts or water heater respectively. Shipping, labour, installation and any other costs associated with the replacement will not be accepted by A.O. Smith.

13.6 Claims

A claim on grounds of the specified warranty must be submitted to the dealer from whom the water heater was purchased, or to another authorised dealer for A.O. Smith water Products Company products. Inspection of the water heater as referred to in articles 1 and 2 shall take place in one of the laboratories of A.O. Smith water Products Company.

13.7 Obligations of A.O. Smith

A.O. Smith grants no other warranty or guarantee over its water heaters nor the (sections or parts of) water heaters supplied for replacement, other than the warranty expressly set out in this Certificate.

Under the terms of the supplied warranty, A.O. Smith is not liable for damage to persons or property caused by (sections or parts, or the glass-lined steel tank of) a (replacement) water heater that it has supplied.

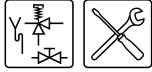

14 Electrical diagram

14.1 Introduction

This chapter shows the electrical diagram(s) and accompanying legend.

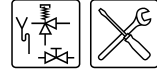

14.2 BFM Electrical Diagram.

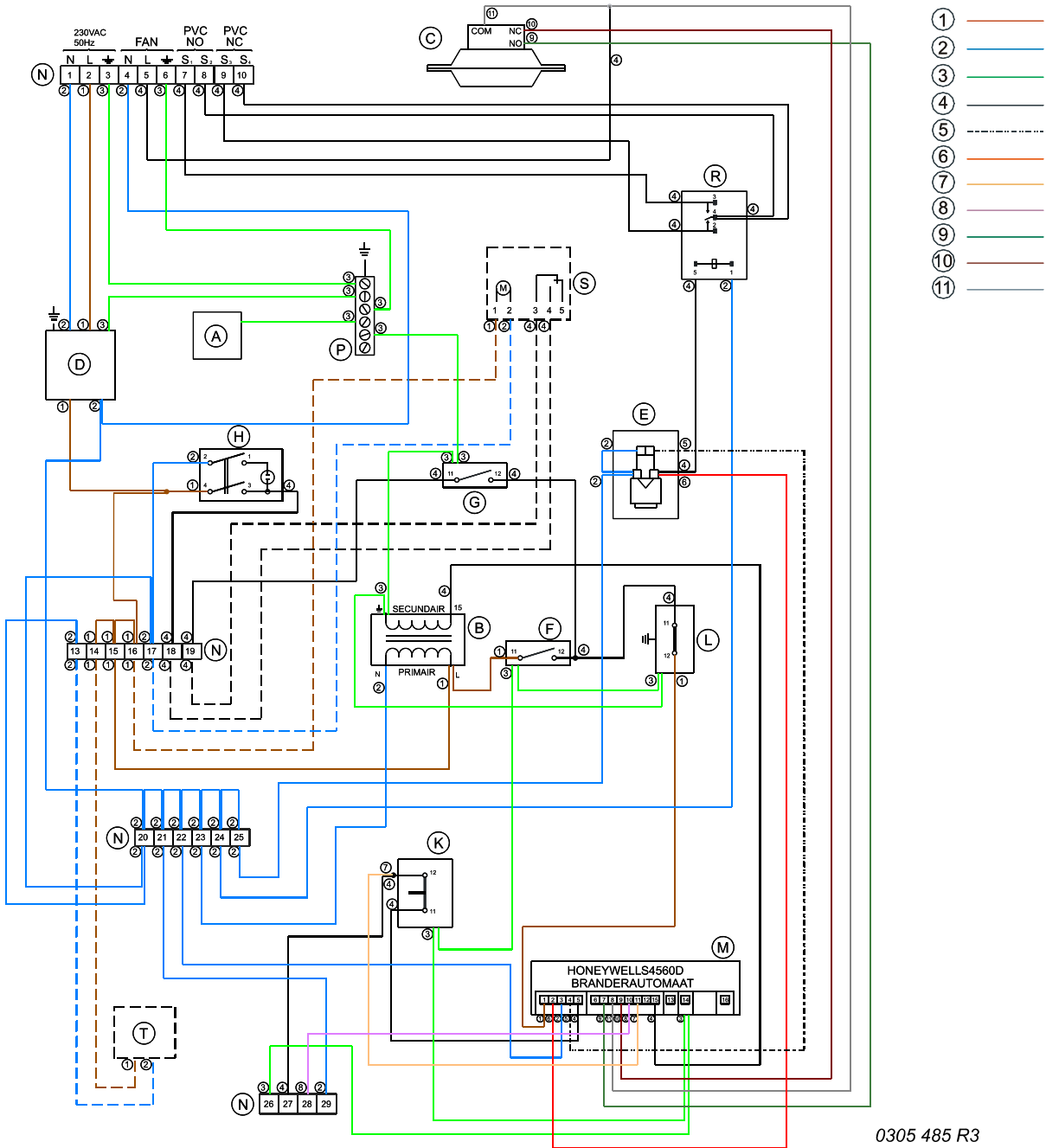

0305 485 R3

1 = brown, 2 = blue, 3 = yellow/green, 4 = black, 5 = white, 6 = red, 7 = white/orange, 8 = white/purple, 9 = black/green, 10 = black/red, 11 = black/white

**COMPONENTS:**

A	Mantle
B	Isolating transformer
C	DPS (Differential air pressure switch)
D	Filter
E	Reset button
F	Frost thermostat
G	Control thermostat
H	ON/OFF switch
K	Safety thermostat
L	High-limit thermostat
M	Burner control
N	Terminal block
P	Earth strip
R	Relay

OPTIONAL COMPONENTS:

S	Clock
T	Potentiostat



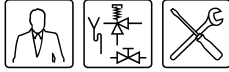

Index

- A**
 - ambient temperature 18
- B**
 - burner pressure 37
- C**
 - claims 68
 - connect
 - air supply 29
 - circulation piping 27, 28
 - cold water side 26, 27
 - electrical 35, 36
 - gas 28
 - hot water side 27
 - shut pipe 26, 27
 - connecting air supply 29
 - connecting circulation pipe 27, 28
 - connecting cold water side 26, 27
 - connecting flue gas discharge 29
 - connecting hot water side 27
 - control thermostat 49
 - conversion to a different gas category 41
- D**
 - disposal 55
 - document contents 9
 - draining 47
- E**
 - electrical connection 35
 - environmental conditions 18
- F**
 - filling 45
 - flame probe 15
 - forms of notation 8
- G**
 - gas category, conversion to different 41
 - gas connection 28
 - general specifications 3
- H**
 - heating cycle 13
 - humidity 18
- I**
 - icons 49
 - explanation 49
 - ignition 13
 - installation engineer 8, 9
 - isolator 36
- L**
 - liability 3
- M**
 - mains power 35, 36
 - maintenance
 - anode 64
 - burner 66
 - finalising 66
 - gas-side 66
 - orifice 66
 - perform 63
 - preparation 63
 - water-side 64
- O**
 - operating modes 51
- P**
 - packaging 17
 - protection 14
- R**
 - reset button 49
 - roof flue terminal 31, 34
 - running 53
- S**
 - scale 65
 - service check 8
 - service engineer 8
 - shunt pump 26, 27
 - specifications 20
 - starting up 53
 - supply pressure 37
 - symbol
 - installation engineer 8
 - service engineer 8
 - user 8
- T**
 - target groups 8
 - to shut down
 - electrically isolating 55
 - longer period 55
 - short period 55
 - trademarks 3
- U**
 - user 8
- W**
 - wall flue terminal 30, 33
 - warranty 67
 - exclusions 68
 - general 67
 - installation and conditions of use 67
 - scope 68
 - water
 - composition 18

