

CE

# ADMR

Commercial Atmospheric  
Water Heater

**ADMR - 40/50/60/80/90/115/135**



Installation, User and Service  
Manual

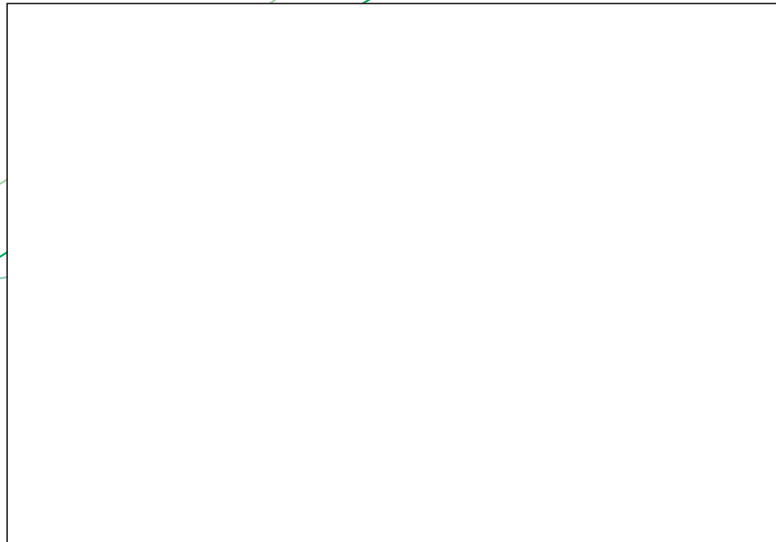

**your installer**



## Read this manual carefully

---

### **Warning**

Read this manual carefully before starting up the water heater. Failure to read this manual and to follow the instructions in this manual may lead to accidents, personal injury, and damage to the appliance.

---

### **Copyright © 2015 A.O. Smith Water Products Company**

All rights reserved.

Nothing from this publication may be copied, reproduced and/or published by means of printing, photocopying or by whatsoever means, without the prior written approval of A.O. Smith Water Products Company.

A.O. Smith Water Products Company reserves the right to modify specifications stated in this manual.

## Trademarks

Any brand names mentioned in this manual are registered trademarks of their respective owners.

## Liability

A.O. Smith Water Products Company accepts no liability for claims from third parties arising from improper use other than that stated in this manual and in accordance with the General Conditions registered at the Eindhoven Chamber of Commerce.

Refer further to the General Conditions. These are available on request, free of charge.

Although considerable care has been taken to ensure a correct and suitably comprehensive description of all relevant components, the manual may nonetheless contain errors and inaccuracies.

Should you detect any errors or inaccuracies in the manual, we would be grateful if you would inform us. This helps us to further improve our documentation.

## More information

If you have any comments or queries concerning any aspect related to the appliance, then please do not hesitate to contact:

A.O. Smith Water Products Company

PO Box 70

5500 AB Veldhoven

Netherlands

Telephone: (free) 0870 - AOSMITH  
0870 - 267 64 84

General: +31 40 294 25 00

Fax: +31 40 294 25 39

E-mail : [info@aosmith.nl](mailto:info@aosmith.nl)

Website: [www.aosmithinternational.com](http://www.aosmithinternational.com)

In the event of problems with connecting to the gas, electricity or water supply, please contact your installation's supplier/installation engineer .

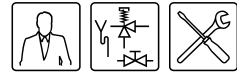
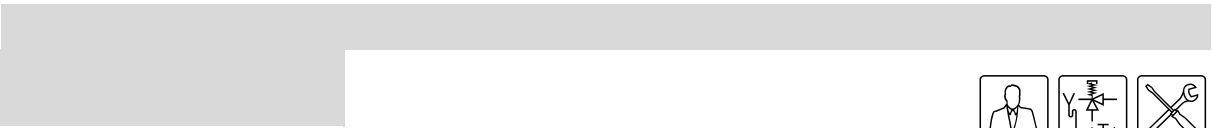



# Table of contents

<b>1</b>	<b>Introduction</b>	<b>7</b>
1.1	About the appliance	7
1.2	What to do if you smell gas-	7
1.3	Regulations	7
1.4	Target groups	8
1.5	Maintenance-	8
1.6	Forms of notation	8
1.7	Overview of this document	9
<b>2</b>	<b>Working principle of the appliance-</b>	<b>11</b>
2.1	Introduction	11
2.2	General working principle of the appliance	11
2.3	The appliance's heating cycle	12
2.4	Protection for the appliance	12
2.5	Safety of the installation	13
<b>3</b>	<b>Installation</b>	<b>15</b>
3.1	Introduction	15
3.2	Packaging	15
3.3	Ambient conditions-	15
3.4	Technical specifications	18
3.5	Installation diagram	22
3.6	Water connections, Vented-	23
3.7	Water connections, Unvented	24
3.8	Gas connection	25
3.9	Chimney flue-	26
3.10	Electrical connection	29
3.11	Checking the supply pressure and burner pressure	33
<b>4</b>	<b>Conversion to a different gas category</b>	<b>37</b>
4.1	Conversion to different category ADMR 40 through 115-	38
4.2	Conversion to a different gas category ADMR 135	40
<b>5</b>	<b>Filling-</b>	<b>43</b>
5.1	Filling the appliance	43
<b>6</b>	<b>Draining</b>	<b>45</b>
6.1	Draining unvented installations	45
6.2	Draining vented installations	46
<b>7</b>	<b>The control panel-</b>	<b>47</b>
7.1	Introduction	47
7.2	Controls	47
7.3	Explanation of icons	47
7.4	Electronic controller ON/OFF switch	47
7.5	Navigation buttons	48
7.6	PC connection	48
<b>8</b>	<b>Status of the appliance-</b>	<b>49</b>
8.1	Introduction	49
8.2	Operating modes	49
8.3	Error conditions	50
8.4	Service condition-	50

## Table of contents

<b>9</b>	<b>Starting and running</b> - - - - -	<b>51</b>
9.1	Starting and running- - - - -	51
9.2	The appliance's heating cycle - - - - -	51
<b>10</b>	<b>Shutting down</b> - - - - -	<b>53</b>
10.1	Introduction - - - - -	53
10.2	Shut the appliance down for a brief period ("OFF mode")- - - - -	53
10.3	Electrically isolating the appliance - - - - -	53
10.4	Shutting the appliance down for a long period - - - - -	53
10.5	Disposal - - - - -	53
<b>11</b>	<b>Main menu</b> - - - - -	<b>55</b>
11.1	Notational convention for menu-related instructions - - - - -	55
11.2	Switching on the "ON mode" - - - - -	55
11.3	Setting the water temperature - - - - -	55
11.4	Week program - - - - -	55
11.5	Extra period- - - - -	59
11.6	Settings- - - - -	60
<b>12</b>	<b>Service program</b> - - - - -	<b>63</b>
12.1	Introduction - - - - -	63
12.2	Setting the hysteresis - - - - -	63
12.3	Displaying the error history - - - - -	63
12.4	Displaying the appliance history - - - - -	64
12.5	Display the selected appliance - - - - -	64
12.6	Switching the pump on or off - - - - -	64
12.7	Setting the service interval - - - - -	64
12.8	Setting the display contrast - - - - -	64
12.9	Setting the display backlight time - - - - -	64
12.10	Setting the display scroll speed - - - - -	64
<b>13</b>	<b>Troubleshooting</b> - - - - -	<b>65</b>
13.1	Introduction - - - - -	65
13.2	Troubleshooting table for general errors - - - - -	66
13.3	Troubleshooting table for displayed errors - - - - -	68
<b>14</b>	<b>Maintenance frequency</b> - - - - -	<b>77</b>
14.1	Introduction - - - - -	77
14.2	Determining service interval - - - - -	77
<b>15</b>	<b>Performing maintenance</b> - - - - -	<b>79</b>
15.1	Introduction - - - - -	79
15.2	Preparation for maintenance - - - - -	79
15.3	Water-side maintenance - - - - -	80
15.4	Gas-side maintenance - - - - -	82
15.5	Finalizing maintenance - - - - -	83
<b>16</b>	<b>Warranty (certificate)</b> - - - - -	<b>85</b>
16.1	General warranty - - - - -	85
16.2	Tank warranty- - - - -	85
16.3	Conditions for Installation and use- - - - -	85
16.4	Exclusions - - - - -	86
16.5	Scope of the warranty - - - - -	86
16.6	Claims - - - - -	86
16.7	Obligations of A.O. Smith - - - - -	86
<b>17</b>	<b>Appendices</b> - - - - -	<b>87</b>
17.1	Introduction - - - - -	87
17.2	Electrical Diagrams ADMR - - - - -	88
17.3	Week program card - - - - -	93

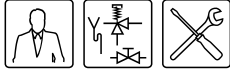

# 1 Introduction

## 1.1 About the appliance

This manual describes how to install, service and use the ADMR appliance. The ADMR appliance is a gas-fired open boiler without fan. ADMR appliances are equipped with a flue gas backflow safeguard.

The ADMR is an appliance of type B<sub>11BS</sub>.

The information in this manual applies to types: ADMR 40, ADMR 50, ADMR 60, ADMR 80, ADMR 90, ADMR 115 and ADMR 135.

The appliance has been manufactured and equipped in accordance with the European standard for gas-fired storage water heaters for the production of domestic hot water (EN 89). The appliances are therefore compliant with the European Directive for Gas Appliances, and are entitled to bear the CE mark.



---

### **Warning**

Read this manual carefully before starting up the water heater. Failure to read the manual and to follow the printed instructions may lead to personal injury and damage to the appliance.

---

## 1.2 What to do if you smell gas

---

### **Warning**

If there is a **gas smell**:

No naked flames! No smoking!

Avoid causing sparks! Do not use any electrical equipment or switch, i.e. no telephones, plugs or bells!

Open windows and doors!

Shut off the mains gas supply valve!

Warn occupants and leave the building!

After leaving the building, alert the gas distribution company or your installation engineer.

---

## 1.3 Regulations

As the (end) user, installation engineer or service and maintenance engineer, you must ensure that the entire installation complies, as a minimum, with the official local:

- building regulations;
  - energy supplier's directives for existing gas installations;
  - directives and technical guidelines for natural gas installations;
  - safety requirements for low-voltage installations;
  - regulations governing the supply of drinking water;
  - regulations governing ventilation in buildings;
  - regulations governing the supply of air for combustion;
  - regulations governing the discharge of products of combustion;
  - requirements for installations that consume gas;
  - regulations governing indoor waste water disposal;
  - regulations imposed by fire brigade, power companies and municipality.
- Furthermore, the installation must comply with the manufacturer's instructions.
- 

### **Note**

Later amendments and/or additions to all regulations, requirements and guidelines published on or prior to the moment of installing, will apply to the installation.

---

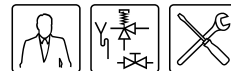



## 1.4 Target groups

The three target groups for this manual are:

- (end) users;
- installation engineers;
- service and maintenance engineers.

Symbols on each page indicate the target groups for whom the information is intended. See the table.

### Target group symbols

Symbol	Target group
	(End) user
	Installation engineer
	Service and maintenance engineer

## 1.5 Maintenance

A service should be carried out at least once a year, both on the water side and on the gas side. Maintenance frequency depends, among other things, on the water quality, the average burning time per day and the set water temperature.

### Note

To determine the correct maintenance frequency, it is recommended to arrange for the service and maintenance engineer to check the appliance on both the water and gas side within three months following installation. Based on this check, the best maintenance frequency can be determined.

### Note

Regular maintenance extends the service life of the appliance.

### Note

Both the end user and the service and maintenance engineer are responsible for regular maintenance. They will need to establish clear agreements on this.

### Note

If the appliance is not regularly maintained, the warranty will become void.

## 1.6 Forms of notation

The following notation is used in this manual:

### Note

Important information.

### Caution

Ignoring this information can lead to the appliance being damaged.

### Warning

Failure to carefully read this information may lead to personal injury and serious damage to the appliance.









































## 1.7 Overview of this document

The table provides an overview of the contents of this document.

### Contents of this document

Chapter	Target groups	Description
<u>Working principle of the appliance</u>	  	This chapter describes how the appliance functions.
<u>Installation</u>	 	This chapter describes the installation activity to be completed before you actually start up the appliance.
<u>Filling</u>	  	This chapter describes how to fill the appliance.
<u>Draining</u>	  	This chapter describes how to drain the appliance.
<u>The control panel</u>	  	This chapter describes the general control of the appliance using the display.
<u>Status of the appliance</u>	  	This chapter describes the status (mode or condition) that the appliance may have, and possible actions to take.
<u>Starting and running</u>	  	This chapter describes how to start the appliance running. The general heating cycle of the appliance is also described.
<u>Shutting down</u>	  	This chapter describes how to shut the appliance down for a brief or long period of time.
<u>Main menu</u>	  	This chapter describes the main menu of the display. This is the actual menu for the user, however the installation engineer and service and maintenance engineers will also need to use this menu.
<u>Service program</u>	 	This chapter describes the service menu. It is mainly intended for the installation engineer and service and maintenance engineers. End users may also refer to this chapter for additional information about the appliance.
<u>Troubleshooting</u>	  	This chapter is mainly intended for the installation engineer and the service and maintenance engineer. It describes appliance errors. These errors are indicated on the display. A troubleshooting table of possible causes and solutions is provided. End users may also refer to this chapter for additional information about the appliance.
<u>Maintenance frequency</u>	 	This chapter describes how to determine the optimum frequency at which to carry out maintenance. Both the end user and the service and maintenance engineer are responsible for regular maintenance. They need to reach clear agreement on this.  <b>Note</b> If the appliance is not regularly maintained, the warranty will become void.
<u>Performing maintenance</u>		This chapter sets out the maintenance tasks to be carried out during a service.
<u>Warranty (certificate)</u>	  	This chapter states the warranty terms and conditions.



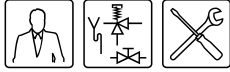

# 2 Working principle of the appliance

## 2.1 Introduction

Topics covered in this chapter:

- General working principle of the appliance;
- The appliance's heating cycle;
- Protection for the appliance;
- Safety of the installation.

## 2.2 General working principle of the appliance

The figure shows a cut-away view of the appliance.

*Cut-away view of the appliance*

### Legend

Only applicable numbers are mentioned.

- 2. hot water outlet
- 4. ThermoControl (electronic controller)
- 7. temperature sensor  $T_1$
- 8. combustion chamber
- 9. anode
- 10. tank
- 11. heat exchanger
- 12. inspection and cleaning opening
- 13. temperature sensor  $T_2$
- 14. cold water inlet
- 15. drain valve
- 16. gas control
- 20. hot surface igniter
- 21. flame probe
- 22. chimney flue
- 24. insulation layer
- 32. flue damper
- 33. draught diverter
- 34. flue gas sensor
- 35. radiation shield/condensation tray
- 36. bar burners/burner tray

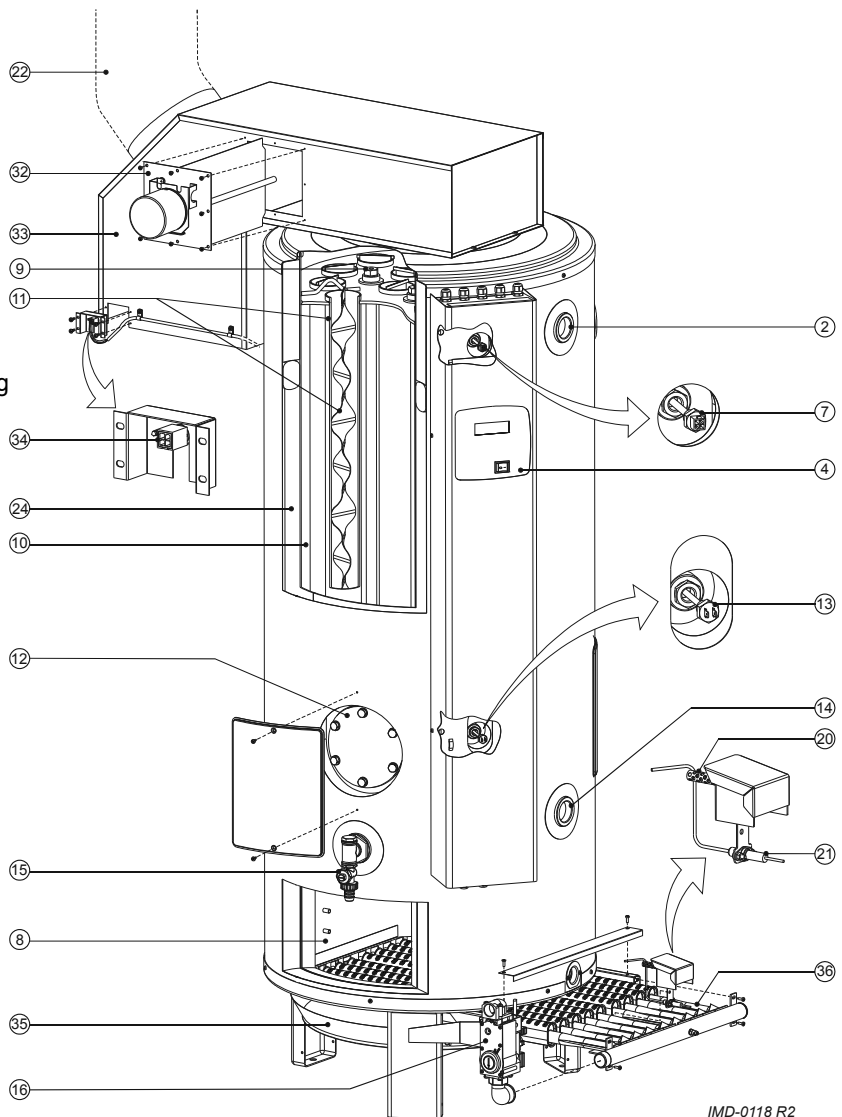

IMD-0118 R2

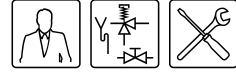

In this appliance, the cold water enters the bottom of the tank through the cold water inlet (14). The heat of combustion is conducted to the water by the combustion chamber (8) and heat exchanger (11). The heated tap water leaves the tank through the hot water outlet (2). Once the appliance is completely filled with water, it will constantly be under mains water pressure. When hot water is drawn from the appliance, it is immediately replenished with cold water.

The gas required for combustion flows via the gas control (16) into the manifold. Orifices are mounted in the manifold. The gas is injected into the burner bars at pressure from these orifices (36). The burner bars together form the burner tray. The injection of gas into the burner bars also draws in the primary air required for combustion. The narrow opening in the orifice causes the gas flow to accelerate. This in turn causes a partial vacuum. It is this partial vacuum that draws in the air (the Venturi effect). Additional air is drawn in through the opening in the burner tray.

The hot surface igniter (20) ensures ignition of the gas/air mixture.

The flue gases released by this combustion are led through the flue tubes (part of 11). Flue baffles (part of 11) are mounted in the flue tubes. These retard the flow of the flue gases, thereby increasing the thermal efficiency of the appliance.

The flue gases are exhausted from the appliance via the draught diverter (33). An energy-saving flue damper (32) is mounted in the draught diverter. The flue damper opens before the burner tray ignites, and closes as soon as the flame is extinguished.

A radiation shield/condensation tray (35) is mounted below the burner tray. This prevents overheating of the floor area below the appliance, as well as serving as a collection tray for condensation water.

The insulation layer (24) prevents heat loss. The inside of the tank is enamelled to protect against corrosion. The anodes (9) offer extra protection.

### 2.3 The appliance's heating cycle

The entire appliance is controlled and monitored by the ThermoControl (electronic controller). The water temperature is measured by temperature sensors T1 (7) in the top of the tank (10) and T2 (13) at the bottom of the tank. These temperatures are sent to the electronic controller. Based on these two observations, the electronic controller calculates a net water temperature:  $T_{net}$ . The value of  $T_{net}$  lies between the temperatures at the top and bottom of the tank. As soon as  $T_{net}$  falls below the set water temperature ( $T_{set}$ ), the electronic controller registers a "heat demand". The gas control (16) is opened, and the gas is mixed with air. This mixture is ignited by the hot surface igniter (20) and the water becomes heated. As soon as  $T_{net}$  rises above  $T_{set}$  the heat demand ends, and the electronic controller stops the heating cycle.

The electronic controller assumes a certain margin both when registering and ending heat demand. We refer to this margin as the hysteresis ([12.2 "Setting the hysteresis"](#)).

### 2.4 Protection for the appliance

#### 2.4.1 Introduction

The electronic controller monitors the water temperature and ensures safe combustion. This is achieved by:

- the [Water temperature protection](#);
- the [Flue gas backflow safeguard](#);
- the [Flame probe](#).



## 2.4.2 Water temperature protection

The electronic controller uses temperatures sensors T1 (7) and T2 (13) to monitor three temperatures that are important for safety. The table explains the functioning of the temperature sensors.

### *Temperature protection*

Protection	Description
Against frost (T1 < 5 °C or T2 < 5 °C)	The frost protection cuts in. The water is heated to 20 °C.
For maximum water temperature (T1 > 85 °C or T2 > 85 °C)	The high-limit safeguard serves to prevent overheating and/or excessive formation of scale in the appliance. If the high-limit safeguard is activated, the heating is stopped. This causes the water in the tank to cool down. Once the water has cooled sufficiently (T1 < 78 °C), the electronic controller resets the appliance.
For extra safety (T1 > 93 °C or T2 > 93 °C)	A lockout error of the water heater controller takes place. The controller must be manually reset before the appliance can resume operation ( <a href="#">8.3 "Error conditions"</a> ). The reset may only be performed if T <sub>1</sub> < 78 °C.

## 2.4.3 Flue gas backflow safeguard

The flue gases are discharged to the outside via the draught diverter (33) and the chimney. To prevent flue gases accumulating in the boiler room, the discharge of flue gases is monitored by a flue gas sensor (34). The flue gas sensor is mounted in the draught diverter.

## 2.4.4 Flame probe

To ensure that no gas can flow when there is no combustion, the water heater is fitted with a flame probe (21). The electronic controller uses this probe to detect the presence of a flame, by means of ionisation detection. The electronic controller closes the gas control the instant it detects that there is a gas flow but no flame.

## 2.5 Safety of the installation

In addition to the appliance's standard built-in safety monitoring, the appliance must also be protected by an expansion vessel, expansion valve, pressure reducing valve, non-return valve and a T&P valve.

The use of an expansion vessel, expansion valve and/or pressure reducing valve depends on the type of installation: unvented or vented.

### 2.5.1 Unvented installation

With an unvented installation, an expansion valve valve and expansion vessel prevent the buildup of excessive pressure in the tank. This prevents damage being caused to the enamelled coating (in the appliance) or to the tank. A non-return valve prevents excessive pressure buildup in the water supply system. This valve also prevents water from flowing backwards from the tank into the cold water supply system. The pressure reducing valve protects the installation against an excessively high water supply pressure (> 8 bar). These components are fitted to the cold water pipe ([3.6 "Water connections, Vented"](#)).

### 2.5.2 Vented installation

With a vented installation, excess pressure is taken up by the open cold water head tank. The height of the head tank determines the working pressure in the water heater, which may not exceed 8 bar. The installation must also be fitted with a vent pipe from the hot water pipe, that opens into the cold water tank.

Ideally, the vent pipe should discharge into a separate tundish/drain or otherwise to the open cold water head tank. The water heater should also be fitted on the hot water side with a stop valve ([3.7.3 "Hot water side"](#)).

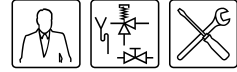

### 2.5.3 T&P valve

A T&P valve is only mandatory in an unvented installation. However, A.O. Smith also recommends the use of a T&P valve in vented installations.

A T&P (Temperature and Pressure Relief) valve monitors the pressure in the tank and the water temperature at the top of the tank. If the pressure in the tank becomes excessive ( $> 10$  bar) or the water temperature is too high ( $> 97$  °C), the valve will open. The hot water can now flow out of the tank. Because the appliance is under water supply pressure, cold water will automatically flow into the tank. The valve remains open until the unsafe situation has been rectified. The appliance is fitted standard with a connecting point for a T&P valve ([3.7.3 "Hot water side"](#)).



# 3 Installation

---

## Warning

Installation work should be carried out by an approved installation engineer in compliance with the general and local regulations imposed by the gas, water and power supply companies and the fire service.

The appliance may only be installed in a room that complies with the requirements stated in national and local ventilation regulations ([1.3 "Regulations"](#)).

---

### 3.1 Introduction

This chapter describes the installation activities to be carried out before the appliance may be started up ([9 "Starting and running"](#)), in particular:

- [Packaging](#);
- [Ambient conditions](#);
- [Technical specifications](#);
- [Water connections, Vented](#);
- [Water connections, Vented](#);
- [Gas connection](#);
- [Chimney flue](#);
- [Electrical connection](#);
- [Checking the supply pressure and burner pressure](#).

For a possible conversion to a different gas category, see conversion ([4 "Conversion to a different gas category"](#)).

### 3.2 Packaging

To avoid damaging the appliance, remove the packaging carefully.

We recommend unpacking the appliance at or near its intended location.

---

## Caution

The appliance may only be manoeuvred in an upright position. Take care that the appliance is not damaged after unpacking.

---

The packaging prevents damage to the appliance during transport. The packaging material chosen is environmentally friendly, recyclable and relatively easy to dispose of in an environmentally aware way.



### 3.3 Ambient conditions

---

## Caution

The appliance may not be used in rooms where chemical substances are stored or used, due to the risk of explosion and/or corrosion of the appliance. Some propellants, bleaching agents, degreasing agents etc. disperse vapours which are explosive and/or which cause accelerated corrosion. If the appliance is used in a room in which such substances are present, the warranty will be void.

---

ADMR appliances are open appliances and may only be installed in an open boiler room. Their type is B<sub>11BS</sub>.

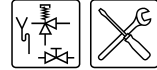

### 3.3.1 Air humidity and ambient temperature

The boiler room must be frost-free, or be protected against frost. The table shows the environmental conditions that must be adhered to for correct functioning of the electronics present in the appliance to be guaranteed.

*Air humidity and ambient temperature specifications*

Air humidity and ambient temperature	
Air humidity	max. 93% RV at +25 °C
Ambient temperature	Functional: $0 \leq T \leq 60$ °C

### 3.3.2 Maximum floor load

In connection with the appliance's weight, take account of the maximum floor loading, refer to the table.

Weight of the appliance filled with water						
ADMR 40	ADMR 50	ADMR 60	ADMR 80	ADMR 90	ADMR 115	ADMR 135
504 kg	578 kg	507 kg	573 kg	522 kg	523 kg	581 kg

### 3.3.3 Water composition

The appliance is intended for heating drinking water. The drinking water must comply with the regulations governing drinking water for human consumption. The table gives an overview of the specifications.

*Water specifications*

Water composition	
Hardness (alkaline earth ions)	> 1.00 mmol/l: <ul style="list-style-type: none"> <li>• German hardness &gt; 5.6° dH</li> <li>• French hardness &gt; 10.0° fH</li> <li>• English hardness &gt; 7.0° eH</li> </ul>
Conductivity	> 125 µS/cm
Acidity (pH value)	7.0 < pH value < 9.5

#### Note

If the water specifications deviate from those stated in the table, then the tank protection cannot be guaranteed (16 "Warranty (certificate)").





### 3.3.4 Working clearances

For access to the appliance, it is recommended that the following clearances are observed (see figure):

- AA: around the appliance's control column and cleaning openings: 100 cm.
- BB: all sides of the appliance: 50 cm.
- Above the appliance (room to replace the anodes):
  - 100 cm if using fixed anodes, or
  - 50 cm if using flexible anodes.

If the available clearance is less than 100 cm, flexible magnesium anodes may be ordered.

---

#### Note

When installing the appliance, be aware that any leakage from the tank and/or connections can cause damage to the immediate environment or floors below the level of the boiler room. If this is the case, the appliance should be installed above a wastewater drain or in a suitable metal leak tray.

The leak tray must have an appropriate wastewater drain and must be at least 5cm deep with a length and width at least 5cm greater than the diameter of the appliance.

---

*Working clearances*

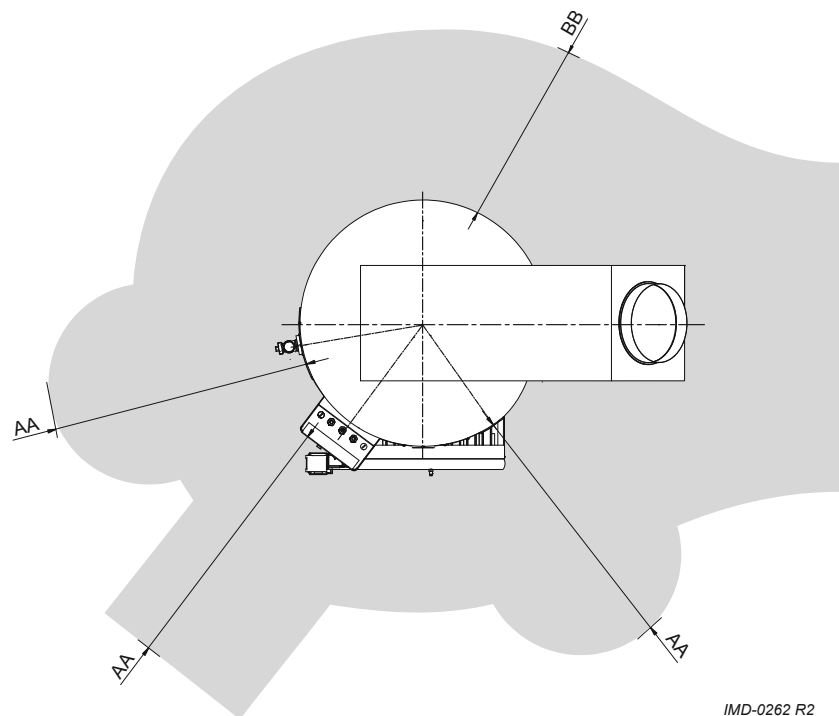

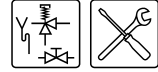

### 3.4 Technical specifications

The appliance is supplied without accessories. Check the dimensions (3.4.1 "Dimensions of the appliance"), gas data (3.4.3 "Gas data") and other specifications (3.4.2 "General and electrical specifications") of any accessories you plan to use.

#### 3.4.1 Dimensions of the appliance

*Plan and elevation of the appliance*

*Legend*

See the table.

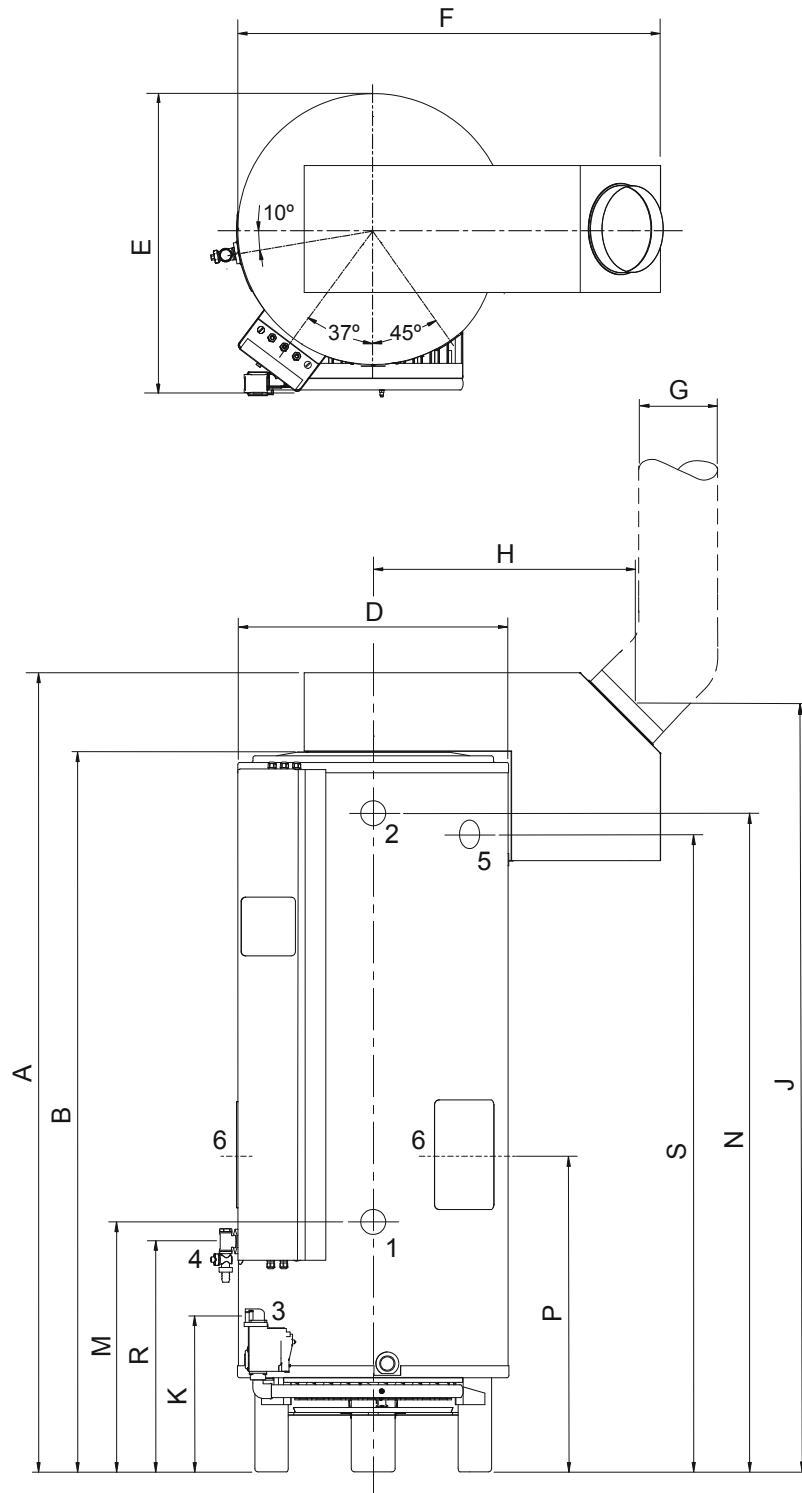

IMD-0135 R2

## Dimensions

Size	Description	Unit	ADMR 40	ADMR 50	ADMR 60	ADMR 80	ADMR 90	ADMR 115	ADMR 135
A	Total height	mm	1900	2100	1900	2100	2000	2085	2085
B	Height of top of appliance	mm	1760	1960	1760	1960	1795	1870	1870
D	Appliance diameter	mm	710	710	710	710	710	710	710
E	Depth	mm	800	800	800	800	800	800	800
F	Width	mm	1100	1100	1100	1100	1105	1105	1105
G	Diameter of chimney flue	mm	150	150	180	180	225	225	225
H	Heart appliance / Heart chimney flue	mm	660	660	660	660	675	675	675
J	Height of chimney flue	mm	1840	2040	1840	2040	1935	2010	2010
K	Height of gas connection	mm	400	400	400	400	400	400	205
M	Height of cold water supply	mm	565	565	565	565	575	650	650
N	Height of hot water outlet	mm	1605	1810	1605	1810	1640	1715	1715
P	Height of cleaning opening	mm	730	730	730	730	740	825	855
R	Height of drain valve connection	mm	500	515	500	515	525	600	595
S	Height of T&P valve connection	mm	1550	1760	1550	1760	1595	1660	1660
1	Cold water supply connection (male)	-	R1 <sup>1</sup> / <sub>2</sub>	R1 <sup>1</sup> / <sub>2</sub>	R1 <sup>1</sup> / <sub>2</sub>	R1 <sup>1</sup> / <sub>2</sub>	R1 <sup>1</sup> / <sub>2</sub>	R1 <sup>1</sup> / <sub>2</sub>	R1 <sup>1</sup> / <sub>2</sub>
2	Hot water outlet connection (female)	-	Rp1 <sup>1</sup> / <sub>2</sub>	Rp1 <sup>1</sup> / <sub>2</sub>	Rp1 <sup>1</sup> / <sub>2</sub>	Rp1 <sup>1</sup> / <sub>2</sub>	Rp1 <sup>1</sup> / <sub>2</sub>	Rp1 <sup>1</sup> / <sub>2</sub>	Rp1 <sup>1</sup> / <sub>2</sub>
3	Gas control connection (female)	-	Rp <sup>3</sup> / <sub>4</sub>	Rp <sup>3</sup> / <sub>4</sub>	Rp <sup>3</sup> / <sub>4</sub>	Rp <sup>3</sup> / <sub>4</sub>	Rp <sup>3</sup> / <sub>4</sub>	Rp <sup>3</sup> / <sub>4</sub>	Rp1
4	Drain valve connection (female)	-	Rp1 <sup>1</sup> / <sub>2</sub>	Rp1 <sup>1</sup> / <sub>2</sub>	Rp1 <sup>1</sup> / <sub>2</sub>	Rp1 <sup>1</sup> / <sub>2</sub>	Rp1 <sup>1</sup> / <sub>2</sub>	Rp1 <sup>1</sup> / <sub>2</sub>	Rp1 <sup>1</sup> / <sub>2</sub>
5	T&P valve connection (female)	-	1 - 11.5 NPT	1 - 11.5 NPT	1 - 11.5 NPT	1 - 11.5 NPT	Rp1 <sup>1</sup> / <sub>2</sub>	Rp1 <sup>1</sup> / <sub>2</sub>	Rp1 <sup>1</sup> / <sub>2</sub>
6	Cleaning/inspection opening	mm	Ø 100	Ø 100	Ø 100	Ø 100	Ø 100	Ø 100	Ø 100

### 3.4.2 General and electrical specifications

DESCRIPTION	Unit	ADMR 40	ADMR 50	ADMR 60	ADMR 80	ADMR 90	ADMR 115	ADMR 135
Capacity	litres	309	357	298	335	278	253	252
Maximum operating pressure	bar	8	8	8	8	8	8	8
Empty weight	kg	195	221	209	238	244	270	329
Heating-up time $\Delta T = 45\text{ }^{\circ}\text{C}$	minutes	30	26	19	17	12	8	7
Number of anodes	-	2	2	2	3	3	4	4
Number of bar burners/orifices	-	3	4	5	7	7	9	6
Number of flue tubes/flue baffles	-	5	6	7	9	12	16	17
Electrical power consumption	W	50	50	50	50	50	50	80
Supply voltage (-15% +10% VAC)	volts	230	230	230	230	230	230	230
Mains frequency	Hz ( $\pm 1\text{Hz}$ )	50	50	50	50	50	50	50
IP class	-	30	30	30	30	30	30	30

DESCRIPTION	Unit	ADMR 40	ADMR 50	ADMR 60	ADMR 80	ADMR 90	ADMR 115	ADMR 135
Load Profile	-	XXL	XXL	XXL	XXL	3XL	3XL	3XL
Energy Efficiency Class (Energy Label)	-	B	B	B	B	-	-	-
Energy Efficiency	%	62	62	61	61	58	57	60
Daily Electricity Consumption	kWh	0,165	0,165	0,165	0,165	0,165	1,376	1,423
Daily Fuel Consumption	kWh GCV	38,977	39,216	40,065	39,847	80,312	78,659	74,360
Mixed Water 40 °C (V40)	ltr.	1077	$\infty$	$\infty$	$\infty$	1105	$\infty$	$\infty$
Additional Load Profile	-	3XL	3XL	3XL	3XL	-	-	-
Energy Efficiency	%	61	66	62	62	-	-	-
Daily Electricity Consumption	kWh	0,180	0,181	0,182	0,183	-	-	-
Daily Fuel Consumption	kWh GCV	75,723	70,450	75,379	74,980	-	-	-
Mixed Water 40 °C (V40)	ltr.	615	759	761	923	-	-	-

### 3.4.3 Gas data

Description $\text{H}_{2\text{H}3+}$	Unit	ADMR 40	ADMR 50	ADMR 60	ADMR 80	ADMR 90	ADMR 115	ADMR 135
<b>Gas category 2H: General</b>								
Orifice diameter	mm	3.20	3.20	3.10	2.95	3.20	3.20	3.90
(1) = Blank plate (2) = Burner pressure regulator (3) = High/low regulator	1, 2 or 3	2	2	2	2	2	2	2
<b>Gas category G20 - 20 mbar</b>								
Nominal load (gross calorific value)	kW	42.2	56.5	66.4	82.5	98.3	126.6	143.4
Nominal output	kW	32.3	42.8	50.2	62.4	74.3	95.8	109.8
Supply pressure	mbar	20	20	20	20	20	20	20
Burner pressure	mbar	8.5	8.5	8.5	8.5	8.5	8.5	11.3
Gas consumption (*)	m <sup>3</sup> /h	4.0	5.4	6.3	7.9	9.4	12.1	13.7
Emissions of Nitrogen Oxides (NO <sub>2</sub> )	mg/kWh	240	235	235	229	283	311	276
<b>Gas category 3+: General</b>								
Orifice diameter	mm	1.70	1.70	1.70	1.50	1.70	1.70	2.25
(1) = Blank plate (2) = Burner pressure regulator (3) = High-low control	1, 2 or 3	1	1	1	1	1	1	3
<b>Gas category G30 - 30 mbar</b>								
Nominal load (gross calorific value)	kW	41.6	55.3	68.2	80.7	96.1	123.5	138.4
Nominal output	kW	32.6	42.8	52.8	62.6	74.5	95.8	108.5
Supply pressure	mbar	30	30	30	30	30	30	30
Burner pressure (†)	mbar	-	-	-	-	-	-	-
Gas consumption (*)	kg/h	3.0	4.0	5.0	5.9	7.0	9.0	10.1
<b>Gas category G31 - 37 mbar</b>								
Nominal load (gross calorific value)	kW	38.4	51.1	63.3	77.7	89.6	113.0	130.1
Nominal output	kW	30.0	39.5	48.9	60.1	69.2	87.4	101.7
Supply pressure	mbar	37	37	37	37	37	37	37
Burner pressure (†)	mbar	-	-	-	-	-	-	-
Gas consumption (*)	kg/h	2.7	3.7	4.5	5.6	6.4	8.1	9.3
(*) Based on 1013.25 mbar and 15 °C.								
(†) If using a blank plate instead of a burner pressure regulator, it is assumed that the burner pressure is equal to the supply pressure. In practice, however, the burner pressure will be lower.								

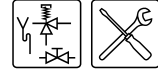

### 3.5 Installation diagram

This figure shows the installation diagram. This diagram is used in the sections in which the actual connection process is described.

#### Installation diagram

#### Legend

Only applicable numbers are mentioned.

1. pressure reducing valve (mandatory)
  3. T&P valve
  4. stop valve (recommended)
  5. non-return valve (mandatory)
  6. circulation pump (optional)
  7. top to bottom circulation pump (optional)
  9. drain valve
  10. manual gas valve (mandatory)
  11. service stop valve (mandatory)
  12. temperature gauge (recommended)
  14. hot water draw-off points
  15. expansion valve (mandatory)
  16. expansion vessel (mandatory)
  17. 3-way aeration valve (recommended)
  18. water tank
  19. float valve
- A. cold water supply  
 B. hot water supply  
 C. circulation pipe  
 D. gas supply  
 E. overflow pipe  
 H. overflow pipe

#### UNVENTED

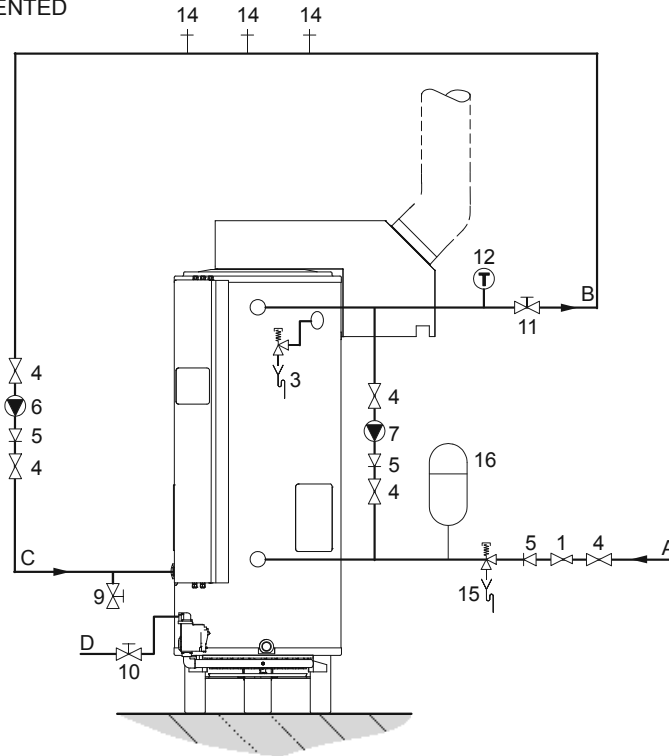

#### VENTED

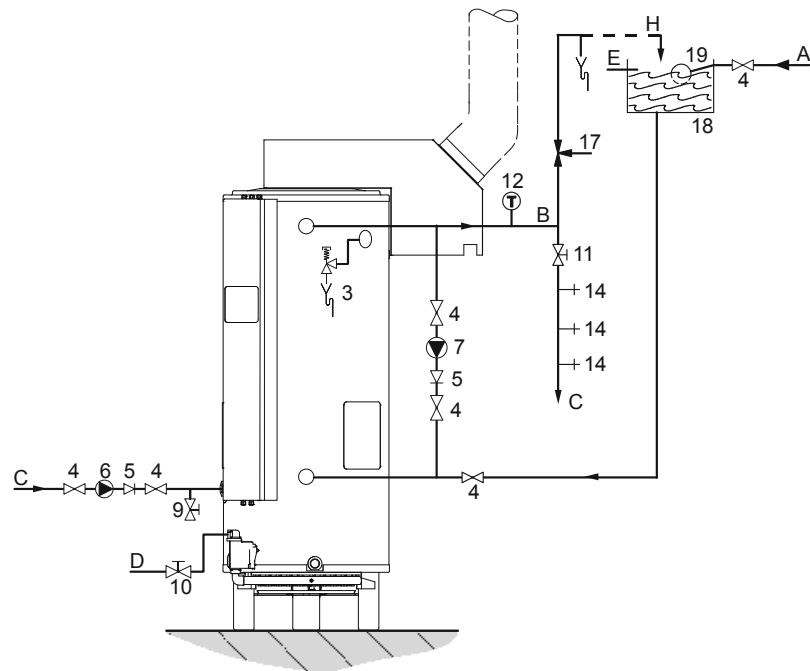

IMD-0466 R0

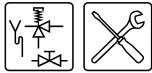

### 3.6 Water connections, Vented

#### **Warning**

The installation should be carried out by an authorised installation engineer, in compliance with general and local regulations (1.3 "Regulations").

#### 3.6.1 Cold water side

See (A) in the installation diagram (3.5 "Installation diagram").

1. Fit an approved stop valve (4) on the cold water side between the cold water head tank (18) and the appliance, as required by regulations (1.3 "Regulations").

#### 3.6.2 Recirculation pipe

You can install a top to bottom circulation pump to prevent water stacking in the boiler.

1. Optional: depending on the draw-off pattern, fit a recirculation pipe ( $\varnothing$  22 mm), a stop valve (11) and a top to bottom circulation pump (7).
2. Fit a non-return valve (5).
3. Fit a stop valve (11).

#### 3.6.3 Hot water side

See (B) in the installation diagram (3.5 "Installation diagram").

#### **Note**

Insulating long hot water pipes prevents unnecessary energy loss.

1. Fit the T&P valve (3).
2. Optional: fit a temperature gauge (12) so you can check the temperature of the tap water.
3. Fit a stop valve (4) in the hot water outlet pipe, for use when servicing.
4. If a circulation pipe is required, continue further by installing the circulation pipe (3.6.5 "Circulation pipe").

#### 3.6.4 Drain valve

1. Fit the standard drain valve (9) supplied with the appliance.
2. If applicable, fit a circulation pipe (3.6.5 "Circulation pipe").  
If not, fit the blind threaded plug and gasket (C) supplied with the drain valve, as shown in the figure.

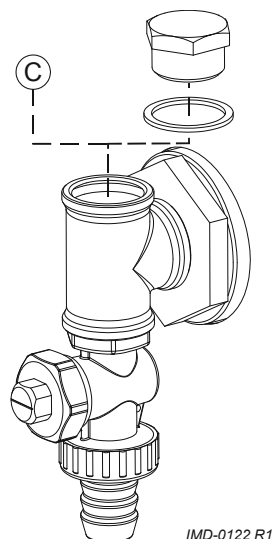

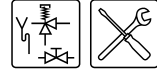

### 3.6.5 Circulation pipe

See (C) in the installation diagram (3.5 "Installation diagram").

If an immediate flow of hot water is required at draw-off points, a circulation pump can be installed. This improves comfort and reduces water wastage.

1. Fit a circulation pump (6) of the correct capacity for the length and resistance of the circulation system.
2. Fit a non-return valve (5) behind the circulation pump to guarantee the direction of circulation.
3. Fit two stop valves for service purposes (4).
4. Connect the circulation pipe to the T-piece at the drain valve (9) as shown in the drain valve figure (3.6.4 "Drain valve").

## 3.7 Water connections, Unvented



### Warning

The installation should be carried out by an authorised installation engineer, in compliance with general and local regulations (1.3 "Regulations").

### 3.7.1 Cold water side

See (A) in the installation diagram (3.5 "Installation diagram").

1. Fit an approved stop valve (4) on the cold water side as required by applicable regulations (1.3 "Regulations").
2. The maximum working pressure of the appliance is 8 bar. Because the pressure in the water pipe at times can exceed 8 bar, you must fit an approved pressure-reducing valve (1).
3. Fit a non-return valve (5) and an expansion vessel (16).
4. Fit an expansion valve (15) and connect the overflow side to an open wastewater pipe.

### 3.7.2 Recirculation pipe

You can install a top to bottom circulation pump to prevent water stacking in the boiler.

1. Optional: depending on the draw-off pattern, fit a recirculation pipe (Ø 22 mm), a stop valve (11) and a top to bottom circulation pump (7).
2. Fit a non-return valve (5).
3. Fit a stop valve (11).

### 3.7.3 Hot water side

See (B) in the installation diagram (3.5 "Installation diagram").



### Note

Insulating long hot water pipes will prevent unnecessary energy loss.

1. Optional: fit a temperature gauge (12) so you can check the temperature of the tap water.
2. Fit the T&P valve (3).
3. Fit a stop valve (11) in the hot water outlet pipe for servicing.





### 3.7.4 Drain valve

1. Fit the standard drain valve (9) supplied with the appliance.
2. If applicable, fit a circulation pipe ([3.6.5 "Circulation pipe"](#)).  
If not, fit the blind threaded plug and gasket (C) supplied with the drain valve, as shown in the figure.

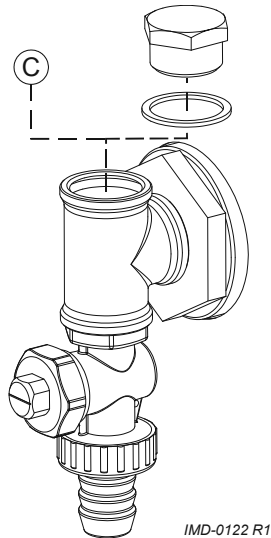

### 3.7.5 Circulation pipe

See (C) in the installation diagram ([3.5 "Installation diagram"](#)).

If an immediate flow of hot water is required at draw-off points, a circulation pump can be installed. This improves comfort and reduces water wastage.

1. Fit a circulation pump (6) of the correct capacity for the length and resistance of the circulation system.
2. Fit a non-return valve (5) behind the circulation pump to guarantee the direction of circulation.
3. Fit two stop valves for service purposes (4).
4. Connect the circulation pipe to the T-piece at the drain valve (9) as shown in the drain valve figure ([3.6.4 "Drain valve"](#)).

## 3.8 Gas connection

### **Warning**

The installation should be carried out by an authorised installation engineer, in compliance with general and local regulations ([1.3 "Regulations"](#)).

### **Caution**

Make sure that the diameter and length of the gas supply pipe are large enough to supply sufficient capacity to the appliance.

See (D) in the installation diagram ([3.5 "Installation diagram"](#)).

1. Fit a manual gas valve (10) in the gas supply pipe.
2. Blow the gas pipe clean before use.
3. Close the manual gas valve.
4. Fit the gas supply pipe to the gas control.

### **Warning**

After fitting, check for leaks.

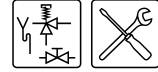

### 3.9 Chimney flue



#### Warning

The installation should be carried out by an authorised installation engineer, in compliance with general and local regulations (1.3 "Regulations").

#### 3.9.1 Introduction

The separately-supplied draught diverter must be used when connecting the appliance to the chimney flue. The flue gas sensor and flue damper supplied standard with the appliance must be mounted in the draught diverter. The electrical parts of the flue damper must also be connected (3.10 "Electrical connection") inside the control column.

#### 3.9.2 Fitting the draught diverter

The draught diverter can be positioned according to preference. Once it is positioned, the draught diverter is secured to the top of the appliance using two screws (6), while it is also supported on a mounting bracket (1) attached to the side of the appliance. The mounting bracket parts can be found in the plastic bag attached behind the control column. The assembly procedure is as follows:

##### Removing the protective cover

#### Legend

- A. screws
- B. protective cap
- C. connector block

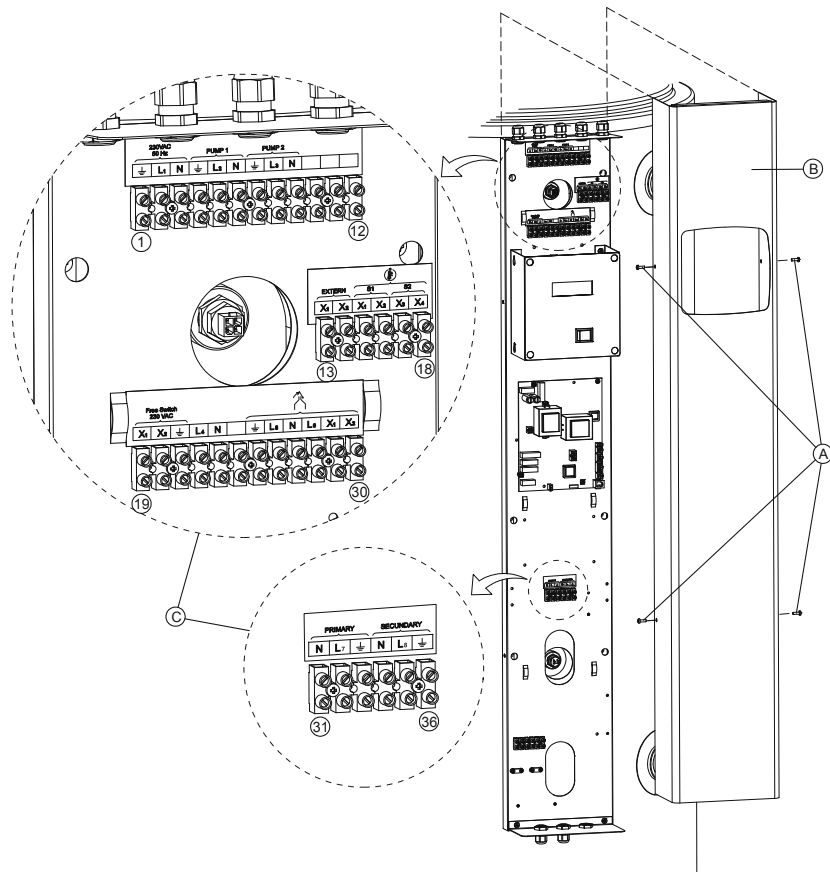

IMD-0125 R2

1. Loosen the 4 screws (A), and remove the protective cover from the control column.  
The bag with parts, including the mounting bracket (and mounting components for the flue gas sensor) can now be seen.
2. Take the mounting bracket out of the bag.

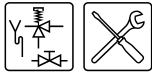

### Installing the draught diverter

#### Legend

- 1 mounting bracket
- 2 holes for mounting bracket
- 3 screws for mounting bracket
- 4 holes for draught diverter
- 5 sealing ring
- 6 screws for draught diverter
- 7 45° bend
- 8 chimney pipe

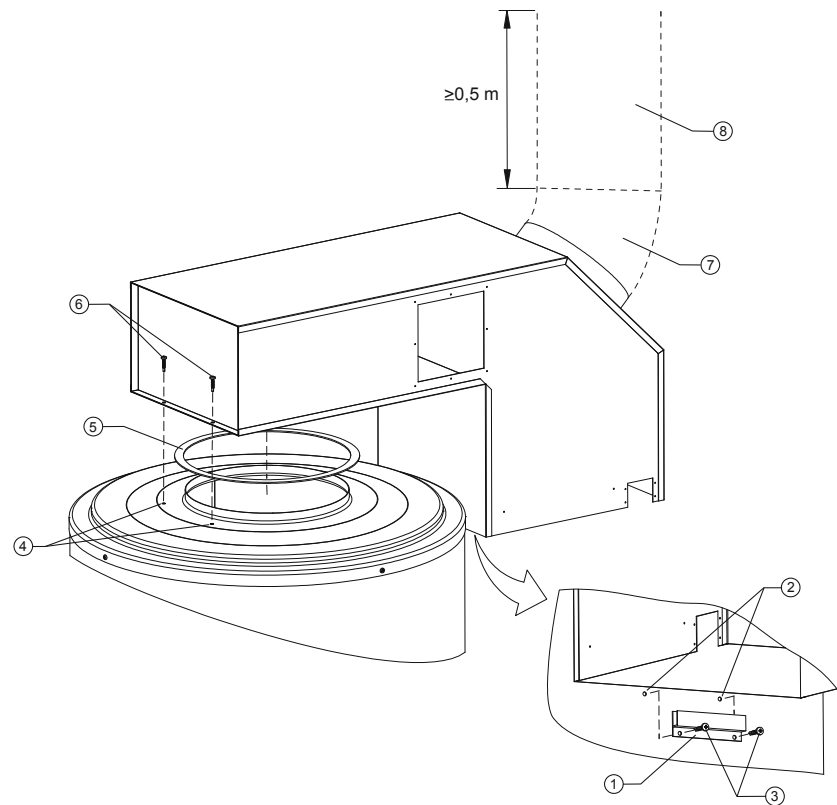

IMD-0123 R1

3. Fit the mounting bracket (1) in such a way that it properly supports the draught diverter.
4. Drill two holes (2) (3.2 mm bit) for the mounting bracket screws.
5. Screw the mounting bracket tightly to the appliance.
6. Place the draught diverter in the mounting bracket, and mark the centres for
7. Now drill two holes (4) into the top of the appliance (3.2 mm bit).
8. Place the sealing ring (5) on the appliance.
9. Screw the draught diverter tightly in place.
10. Fit:
  - a 45° bend (7) onto the outlet of the draught diverter, followed by:
  - a corrosion-resistant vertical chimney pipe (8) of at least 0.5 metre length,
  - the remaining flue components.

---

 **Note**  
Use flue components that comply with the regulations ([1.3 "Regulations"](#)).

 **Note**  
Make sure that the chimney flue discharges into an area approved for this type of appliance.

---

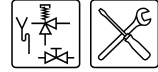

### 3.9.3 Fitting the flue damper

The following parts can be found in the separate package for the flue damper, supplied with the appliance: the complete assembled flue damper (1), a mounting plate (2) with hole for the flue damper shaft, and fastening screws. You may fit the flue damper in either the left or the right hand side of the draught diverter.

*Flue damper*

#### Legend

- 1 flue damper
- 2 mounting plate

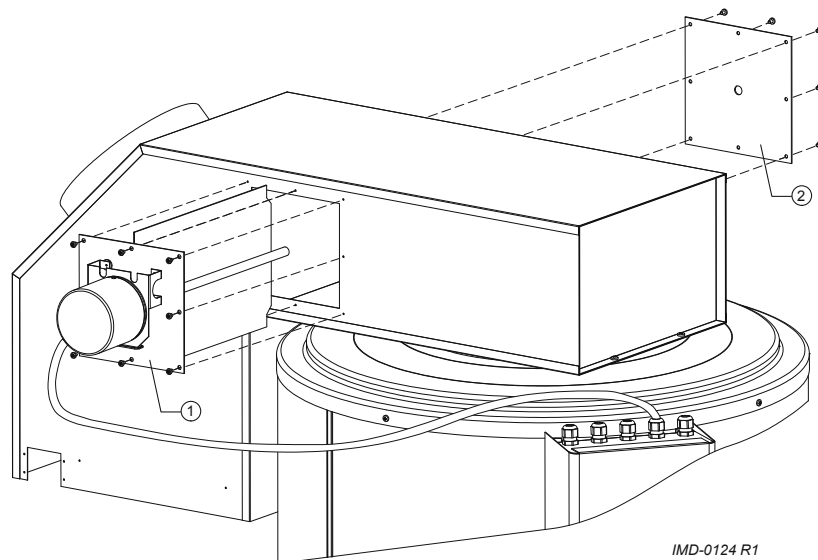

1. Take the flue damper (1) out of the packaging.
2. There are two cover plates on the draught diverter, one on each side. Unscrew these.
3. Fit the mounting plate (2) with shaft hole, supplied with the flue damper, on one side of the draught diverter.
4. Slide the flue damper, as shown in the figure, into the other opening in



#### Note

See [Electrical connection](#) for the flue damper electrical connections.

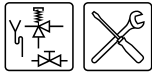

### 3.9.4 Fitting the flue gas sensor

Attached to the control column is a plastic bag containing the flue gas sensor and related mounting components.

The sensor lead is already connected inside the control column, but not

#### *Flue gas safety*

#### *Legend*

- 1 bracket
- 2 flue gas sensor
- 3 fastening bracket
- 4 plug
- 5 sensor lead

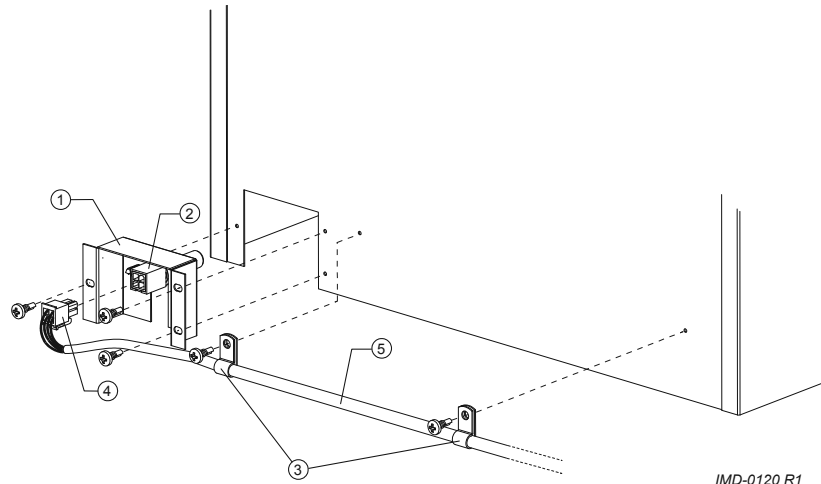

Fit the flue gas sensor as follows:

1. Take the bracket (1) (with flue gas sensor (2) already fitted) from the packaging.
2. Place the bracket in the draught diverter and screw the bracket firmly in place.
3. Bend the cable clips (3) around the flue gas sensor lead.
4. Click the plug (4) of the sensor cable (5) into the flue gas sensor.
5. Screw the cable clips (3) tightly into the draught diverter and the

### 3.10 Electrical connection

#### **Warning**

The installation should be carried out by an authorised installation engineer, in compliance with general and local regulations ([1.3 "Regulations"](#)).

#### 3.10.1 Introduction

Topics covered in this paragraph:

- [Preparation](#);
- [Connecting the mains power](#);
- [Connecting flue damper](#).

Optionally, it is possible to connect an isolating transformer, a continuous pump, a program-controlled pump, an extra ON mode switch and an extra alarm signal to the appliance. For these options, see:

- [Connecting an isolating transformer](#);
- [Connecting a continuous pump](#);
- [Connecting top to bottom circulation pump](#);
- [Connecting an extra ON mode switch \("Tank ON"\)](#);
- [Connecting an extra error signal \("Alarm OUT"\)](#).

#### **Note**

The optional components are not included in the rating for electrical power consumption stated in the table ([3.4.2 "General and electrical specifications"](#)).

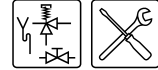

### 3.10.2 Preparation



#### Caution

The appliance is phase-sensitive. It is **absolutely essential** to connect the mains phase (L) to the phase of the appliance, and the mains neutral (N) to the neutral of the appliance.



#### Caution

There may be **no potential difference** between neutral (N) and earth ( $\perp$ ). If this is the case, then an isolating transformer must be applied in the supply circuit (3.10.5 "Connecting an isolating transformer").

For more information or to order this isolating transformer, please contact A.O. Smith Water Products Company.

The figure shows a view of the terminal blocks, and the table explains the relevant connections.

#### Terminal blocks

#### Legend

- A. screws
- B. protective cap
- C. connector block

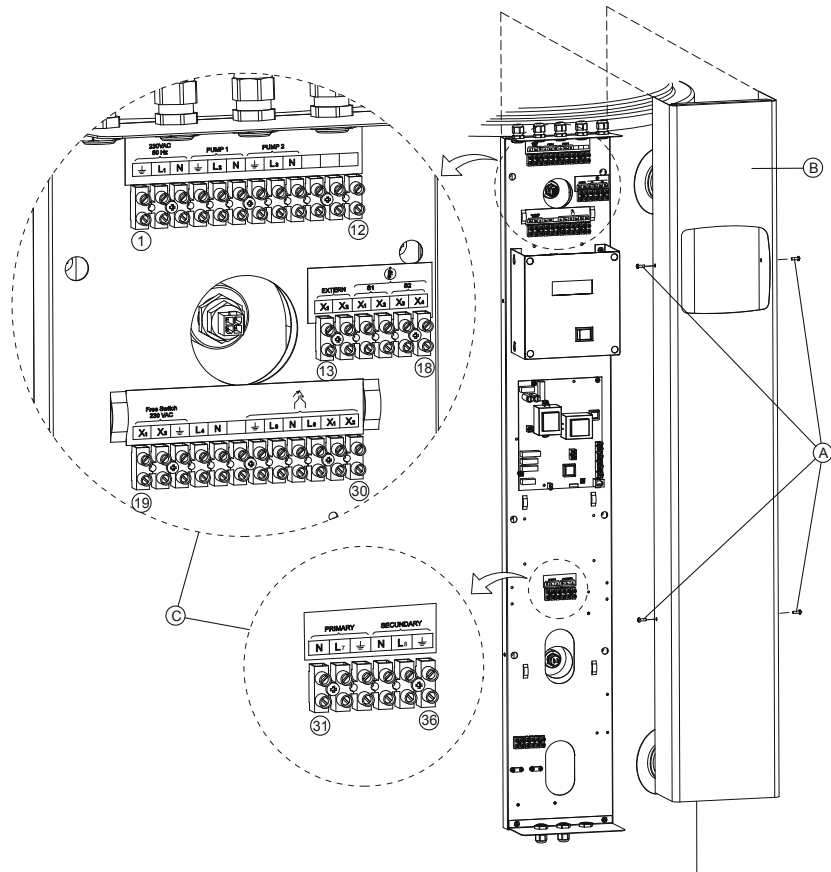

IMD-0125 R2

In preparation you must first remove the protective cover from the control

1. Undo the 4 screws (A) and remove the protective cover (B) from the electrical section. The terminal blocks (C) will now be visible.

Consult the Electrical Diagrams ADMR for the electrical component connections.

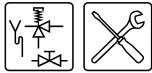

### Terminal block

Mains power			Top to bottom circulation pump			Continuous pump			Unused		
⏚	L1	N	⏚	L2	N	⏚	L3	N	-	-	-
1	2	3	4	5	6	7	8	9	10	11	12

Tank ON		Flue gas safety			
		S1		S2	
X1	X2	X1	X2	X3	X4
13	14	15	16	17	18

Alarm Out			Relay power		Unu sed	Flue damper					
X!	X2	⏚	L4	N	-	⏚	L5	N	L6	X1	X2
19	20	21	22	23	24	25	26	27	28	29	30

Isolating transformer					
Primary			Secondary		
N	L7	⏚	N	L8	⏚
31	32	33	34	35	36

### 3.10.3 Connecting the mains power

The appliance is supplied without a power cable and isolator.

#### Note

In order to receive electrical power, the appliance has to be connected to the mains power by means of a permanent electrical connection. A double-pole isolator with a contact gap of at least 3 mm must be fitted between this permanent connection and the appliance. The power cable must have cores of at least 3 x 1.0 mm<sup>2</sup>.

#### Warning

Leave the appliance isolated until you are ready to start it up.

1. Feed the power cable through the metric strain relief to the top side of the control column.
2. Connect the earth (⏚), live (L<sub>1</sub>) and neutral (N) of the power cable to terminals 1 through 3 in the connector block as stated in the table.
3. Turn the strain relief tight to clamp the lead.
4. If you do not need to make any more connections, fit the protective cover onto the control column.
5. Connect the power cable to the isolator.

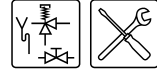

#### 3.10.4 Connecting flue damper

1. Feed the power cable through the metric strain relief in the top of the control column.
2. Connect earth ( $\perp$ ), live ( $L_5$ ) and neutral (N) to terminals 25, 26 and 27. Next connect the three coded black wires (1 through 3) to terminals 28), lead 2 to terminal 29 ( $X_1$ ) and lead 3 to terminal 30 ( $X_2$ ). See the terminal block connections table (3.10.2 "Preparation").
3. Turn the strain relief tight to clamp the lead.
4. If you do not need to make any more connections, fit the protective cover onto the control column.

#### 3.10.5 Connecting an isolating transformer

An isolating transformer should be used if there is a case of 'floating neutral'.

1. Refer to the fitting instructions provided with the isolating transformer. (Contact the supplier for details of the correct isolating transformer.)
2. Connect the cables from the isolating transformer to terminals 31 through 36 of the terminal block as indicated in the accompanying instructions. If necessary, consult the Electrical Diagrams ADMR.
3. If you do not need to make any more connections, fit the protective cover onto the control column.

#### 3.10.6 Connecting a continuous pump

The continuous pump will start up as soon as mains power is connected to the

1. Feed the power cable through the metric strain relief in the top of the control column.
2. Connect earth ( $\perp$ ), live ( $L_1$ ) and neutral (N) to terminals 7, 8 and 9 as indicated in the terminal block connections table (3.10.2 "Preparation").
3. Turn the strain relief tight to clamp the lead.
4. If you do not need to make any more connections, fit the protective cover onto the control column.

#### 3.10.7 Connecting top to bottom circulation pump

The top to bottom circulation pump is program-controlled. Switching on of the shunt pump is determined by settings of the electronic controller.

1. Feed the power cable through the metric strain relief in the top of the control column.
2. Connect earth ( $\perp$ ), live ( $L_1$ ) and neutral (N) to terminals 4, 5 and 6 as indicated in the terminal block connections table (3.10.2 "Preparation").
3. Turn the strain relief tight to clamp the lead.
4. If you do not need to make any more connections, fit the protective cover onto the control column.

#### 3.10.8 Connecting an extra ON mode switch ("Tank ON")

Tank ON is a facility for connecting an external ON/OFF switch. In the OFF position, the programmed operating mode is active. In the ON position, the programmed operating mode is overruled, and "ONmode" is active.

1. Feed the power cable through the metric strain relief in the top of the control column.
2. Connect cables ( $X_1$  and  $X_2$ ) to terminals 13 and 14 as indicated in the terminal block connections table (3.10.2 "Preparation").
3. Turn the strain relief tight to clamp the lead.
4. If you do not need to make any more connections, fit the protective cover onto the control column.





### 3.10.9 Connecting an extra error signal ("Alarm OUT")

Alarm OUT is a potential free terminal that is switched when an error is detected. This can be used to signal errors, for example with a lamp. A 230 V circuit can be directly powered. For other voltages, a specific relay with cable harness and instructions is available from A.O. Smith. The power to this relay can be connected to terminals 22 and 23.

1. Feed the power cable through the metric strain relief in the top of the control column.
2. Connect the live cables (X<sub>1</sub> and X<sub>2</sub>) to terminals 19 and 20 as indicated in the terminal block connections table (3.10.2 "Preparation").
3. If required, connect earth ( $\perp$ ) to terminal 21.
4. Turn the strain relief tight to clamp the lead.
5. If you do not need to make any more connections, fit the protective cover onto the control column.

### 3.11 Checking the supply pressure and burner pressure

**Note**  
Before starting the appliance and/or checking the supply pressure and burner pressure, you must fill (5 "Filling") the appliance.

**Caution**  
Before starting up for the first time or after conversion, you must always check the supply pressure and burner pressure.

**Note**  
The easiest way to check the gas pressures is by using two pressure gauges. This procedure assumes that these two gauges are available.

#### Gas control for ADMR 40 through 115

##### Legend

Only applicable numbers are mentioned.

1. burner pressure regulator
2. burner pressure regulator cap
3. burner pressure regulator adjustment screw
4. gas control connector
5. blank plate
6. supply pressure test nipple
7. gas control
8. manifold test nipple

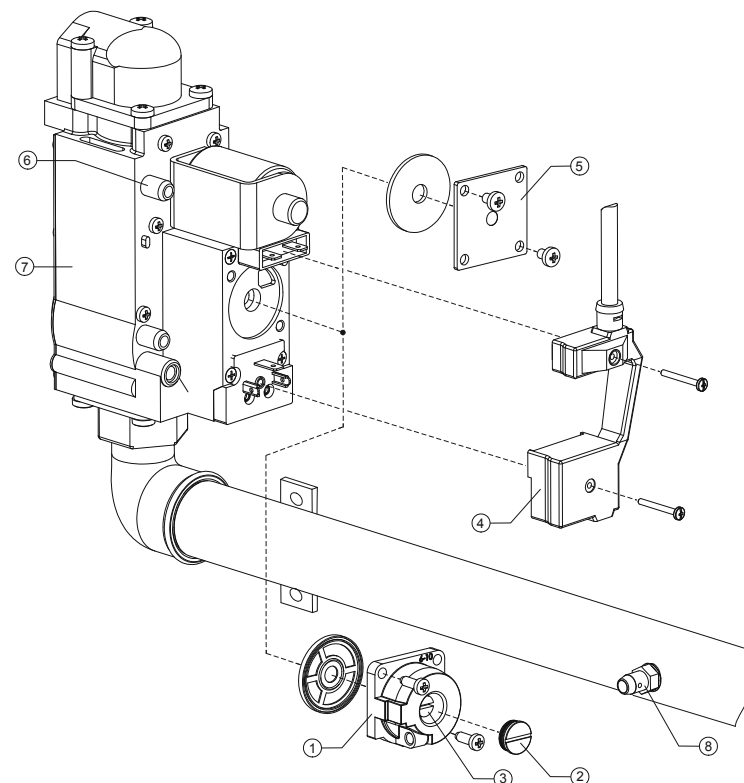

IMD-0127 R1

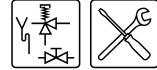

### Gas control for ADMR 135

#### Legend

Only applicable numbers are mentioned.

1. burner pressure regulator
2. burner pressure regulator cap
3. burner pressure regulator adjustment screw
6. supply pressure test nipple
7. gas control
8. manifold test nipple
9. high-low control

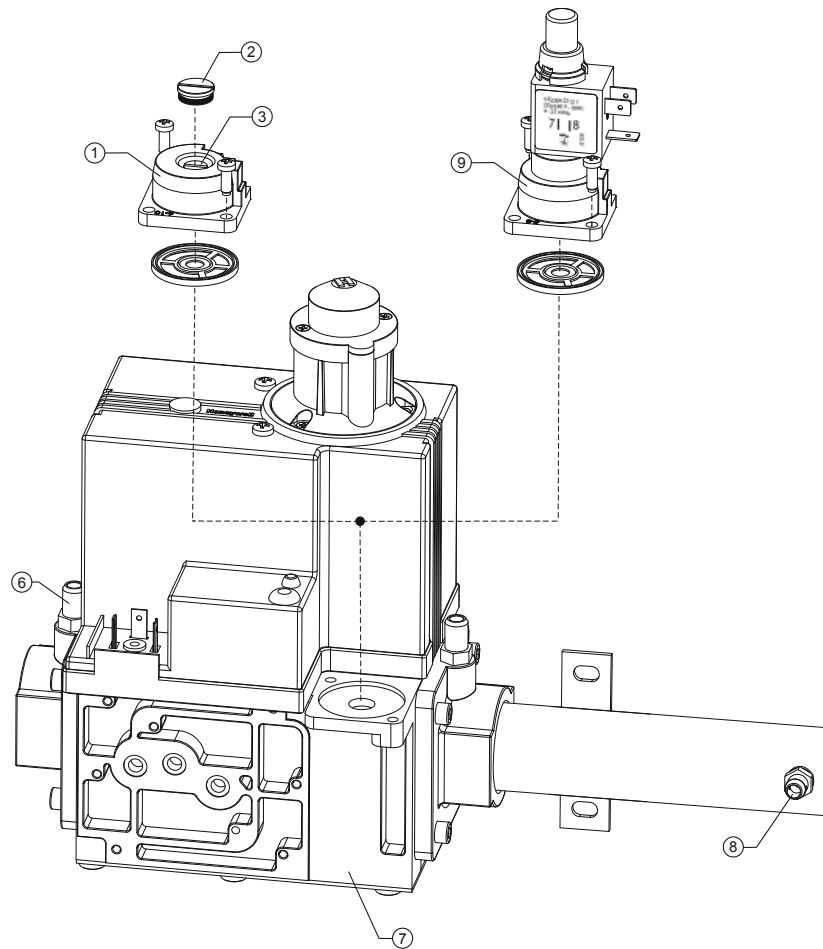

IMD-0129 R1

#### 3.11.1 Preparation

1. Isolate the appliance from the power supply (10.3 "Electrically isolating the appliance").
2. There are two test nipples on the gas control. Test nipple (6) is used to check the supply pressure. The other test nipple on the gas control is not used. The manifold test nipple (8) is used to measure the burner pressure. Sealing screws are located inside the test nipples. Loosen both sealing screws by a few turns. Do not completely loosen them; they can be difficult to re-tighten.
3. Connect a pressure gauge to the manifold test nipple (8).
4. Open the gas supply and bleed the air from the mains gas supply via test nipple (6).
5. Connect a pressure gauge to the manifold test nipple (6) when gas starts to flow from this nipple.
6. Switch on the power to the appliance using the isolator on the appliance.
7. Switch the electronic controller **ON** by setting the O/I switch to **position I**.



The display will now show **INTERNAL CHECK** for about 10 seconds and go to the main menu.

```
INTERNAL CHECK
```

```
MENU
→OFF
← ON
▽ WEEK PROGRAM
```

8. Activate the "ON mode" by going through the following steps:

- Press the blue arrow once (↓) to position the cursor in front of **ON** and press **ENTER**. The display shown here will appear.

```
→START OPERATION
← CHANGE SETPOINT
▽ Tset=65°C
```

- Confirm the **ENTER** by pressing **START OPERATION**.

The appliance is now in the "ON mode" and will ignite.

9. When the display shows the text **RUNNING**, you must wait about 1 minute before reading the dynamic pressures.
10. Use the pressure gauge to read the supply pressure at test nipple (6). Refer to the gas data table ([3.4.3 "Gas data"](#)).

---

 **Note**

Consult the mains gas supply company if the supply pressure is not correct.

---

11. Use the pressure gauge to read the burner pressure at nipple (8). Refer to the gas data table ([3.4.3 "Gas data"](#)).

---

 **Note**

If the burner pressure is incorrect and the appliance is fitted with a blank plate or high-low control, then you **cannot adjust** the pressure. In this case, consult your installation engineer or supplier. If the appliance is indeed fitted with a burner pressure regulator, the pressure can be adjusted by following the steps below.

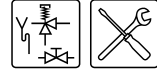

---

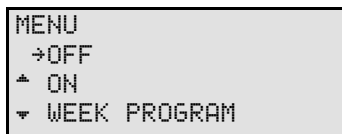

### 3.11.2 Checking burner pressure

1. Remove the cap (2) from the burner pressure regulator.
2. Depending on the correction required, correct the burner pressure by turning adjustment screw (3):
  - Adjustment screw anticlockwise: burner pressure decreases.
  - Adjustment screw clockwise: burner pressure increases.
3. Cover the opening of the adjusting screw and check the burner pressure against the value given in the gas data table (3.4.3 "Gas data").
4. If the pressure reading is not correct, repeat the burner pressure adjustment until the correct pressure is reached.
5. Fit the cap (2) back on the burner pressure regulator.
6. Activate the "OFF mode" of the electronic controller:



7. If the MENU is not displayed:
  - press .
  - Use  and  to place the cursor beside OFF.
  - Confirm with ENTER.
8. Turn off the electronic controller.

### 3.11.3 Finalize

1. Shut off the gas supply.
2. Disconnect the two pressure gauges and retighten the sealing screws in the test nipples.
3. Replace the cover.

---

#### Note

Before starting-up the appliance, take time to fill in the warranty card supplied with the appliance. This enables us to guarantee the quality of our systems, and to further enhance our warranty procedure.

Please return this card as soon as possible. Your customer will then receive a warranty certificate with our warranty conditions.

---

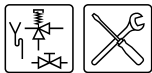

# 4 Conversion to a different gas category

## **Caution**

The conversion may only be carried out by an authorised installation engineer.

If the appliance must operate on a family of gases (LP gas or natural gas) or other gas category than that for which the appliance has been set at the factory, the appliance will have to be adapted using a special conversion kit.

## **Caution**

You must check the supply pressure and burner pressure once the conversion is complete.

This chapter covers the following:

- Conversion to different category ADMR 40 through 115;
- Conversion to a different gas category ADMR 135.

### *Exchanging orifices*

#### *Legend*

1. cover plate
2. retaining strips
3. orifice with stamped figures

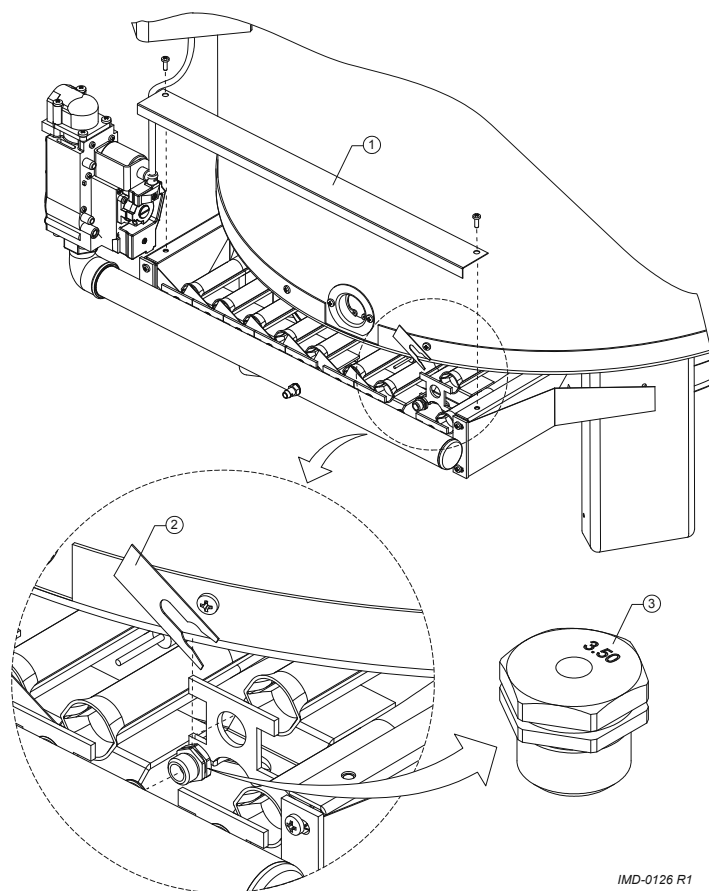

IMD-0126 R1

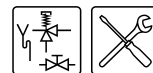

#### 4.1 Conversion to different category ADMR 40 through 115

1. Isolate the appliance from the power supply ([10.3 "Electrically isolating the appliance"](#)).
2. Shut off the gas supply.



#### Caution

The burner can be hot.

3. Unscrew the cover plate (1) from the burner support.
4. Use a suitable tool to remove the retaining strips (2). Note that the retaining strips have very sharp edges. Withdraw the retaining strips straight upwards.



#### Note

The radiation shield / condensation tray can be temporarily loosened to simplify disassembly of the burner.

5. Remove the burners one by one from their brackets at the front. To do this, you first move them away from you and then downwards. The orifices will now be accessible
6. Remove the orifices.
7. Select and fit the correct orifices from the conversion kit, based on the gas data table ([3.4.3 "Gas data"](#)). The orifice diameter is stamped on the orifice itself, see (3).
8. Re-fit the burners back in their original position.
9. Re-fit the retaining strips.
10. If the radiation shield / condensation tray was loosened, re-fasten it.

#### Conversion of gas control

#### Legend

Only applicable numbers are mentioned.

1. burner pressure regulator
4. gas control connector
5. blank plate
6. supply pressure test nipple
7. gas control

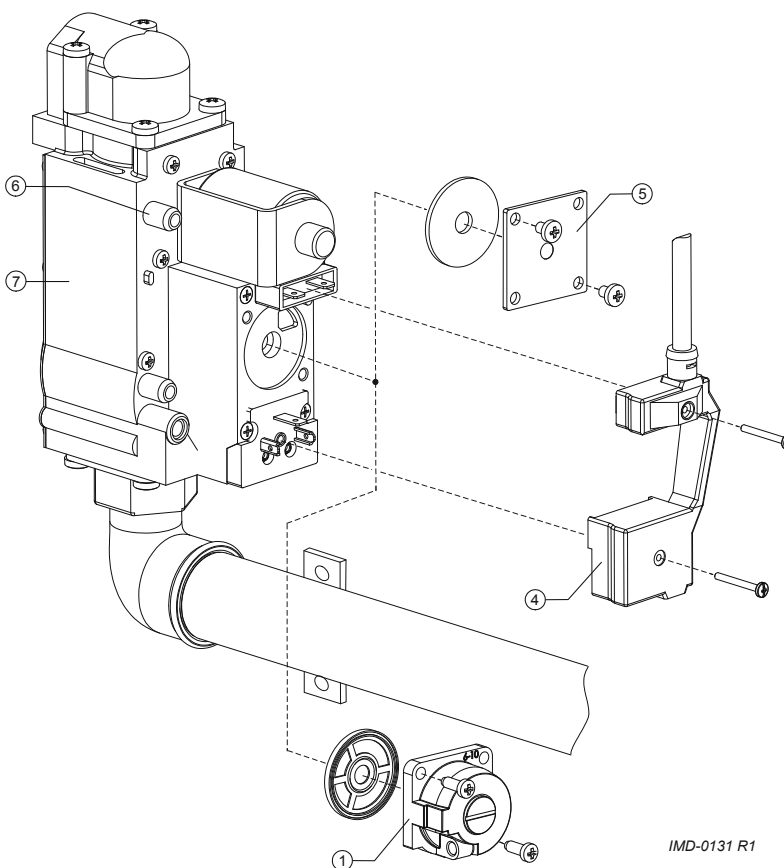

IMD-0131 R1



11. Check whether there is a burner pressure regulator (1) attached to the gas control, or simply a blank plate (5).

---

**Note**

If the supply pressure for a gas category is the same as the burner pressure (see the gas data table (3.4.3 "Gas data")) then the gas control must be fitted with a blank plate with cork gasket. A burner pressure that deviates in comparison to the supply pressure requires the use of a burner pressure regulator with rubber gasket. Each conversion kit contains all the necessary components.

---

12. If the blank plate or burner pressure regulator need to be replaced:
  - Unscrew the connector (4) of the gas control.
  - If necessary, remove the blank plate or burner pressure regulator (5) or burner pressure regulator (1).
  - If necessary, fit the blank plate or burner pressure regulator supplied with the conversion kit.
  - Fit the connector (4) of the gas control.
13. Check the supply pressure and burner pressure (3.11 "Checking the supply pressure and burner pressure").
14. Remove the sticker showing the new gas category from the conversion kit, and attach it below the appliance's rating plate. This clearly indicates that the appliance may no longer be run on the gas for which it was originally supplied.
15. Start the appliance (9.1 "Starting and running").

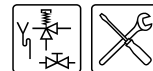

## 4.2 Conversion to a different gas category ADMR 135

### 4.2.1 Introduction

This paragraph describes:

- Conversion from LP gas to natural gas;
- Conversion from natural gas to LP gas.

*Conversion of gas control*

#### Legend

Only applicable numbers are mentioned.

- 1. burner pressure regulator
- 7. gas control
- 9. high-low control

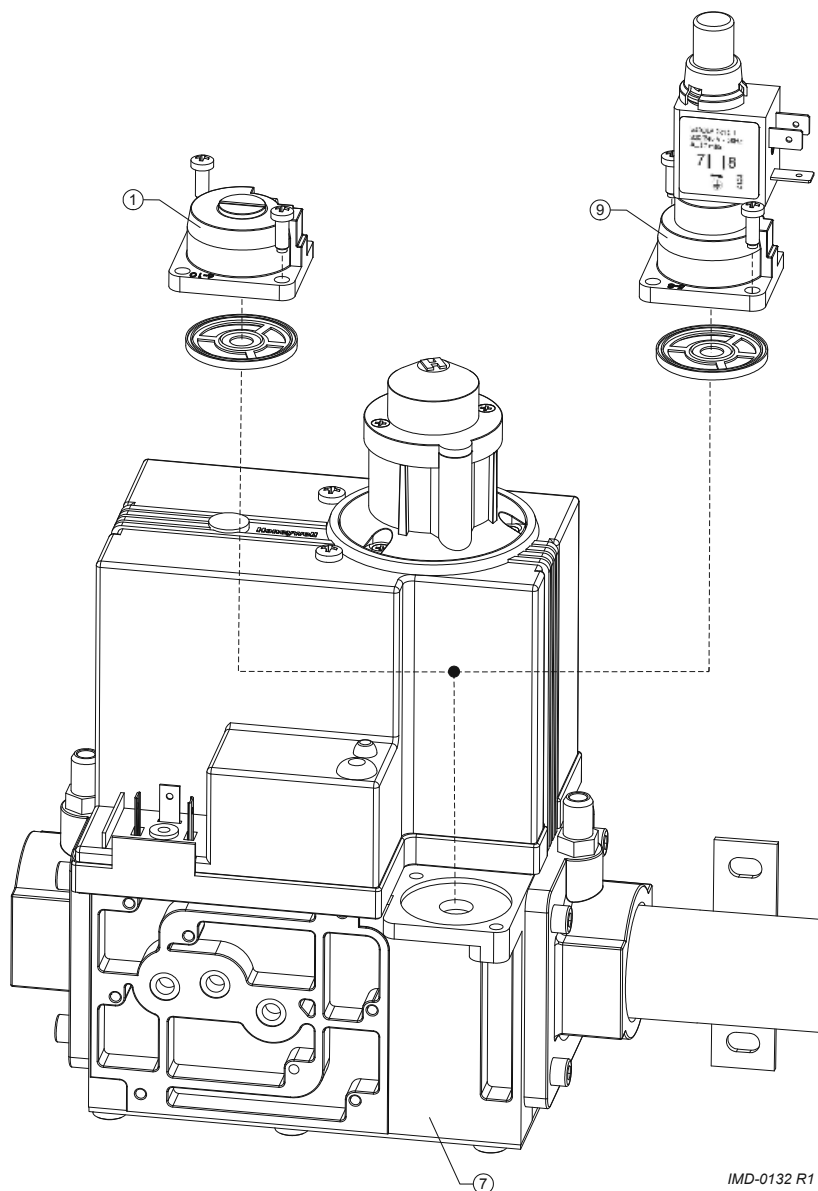





## 4.2.2 Conversion from LP gas to natural gas

### Installing and removing add-on components

#### Legend

Only applicable numbers are mentioned.

- 4. timers
- 5. bracket
- 6. 6-contact terminal strip
- 7. pull reliefs
- 8. 9-contact terminal strip
- 9. metric pull relief
- 10. high-low control lead

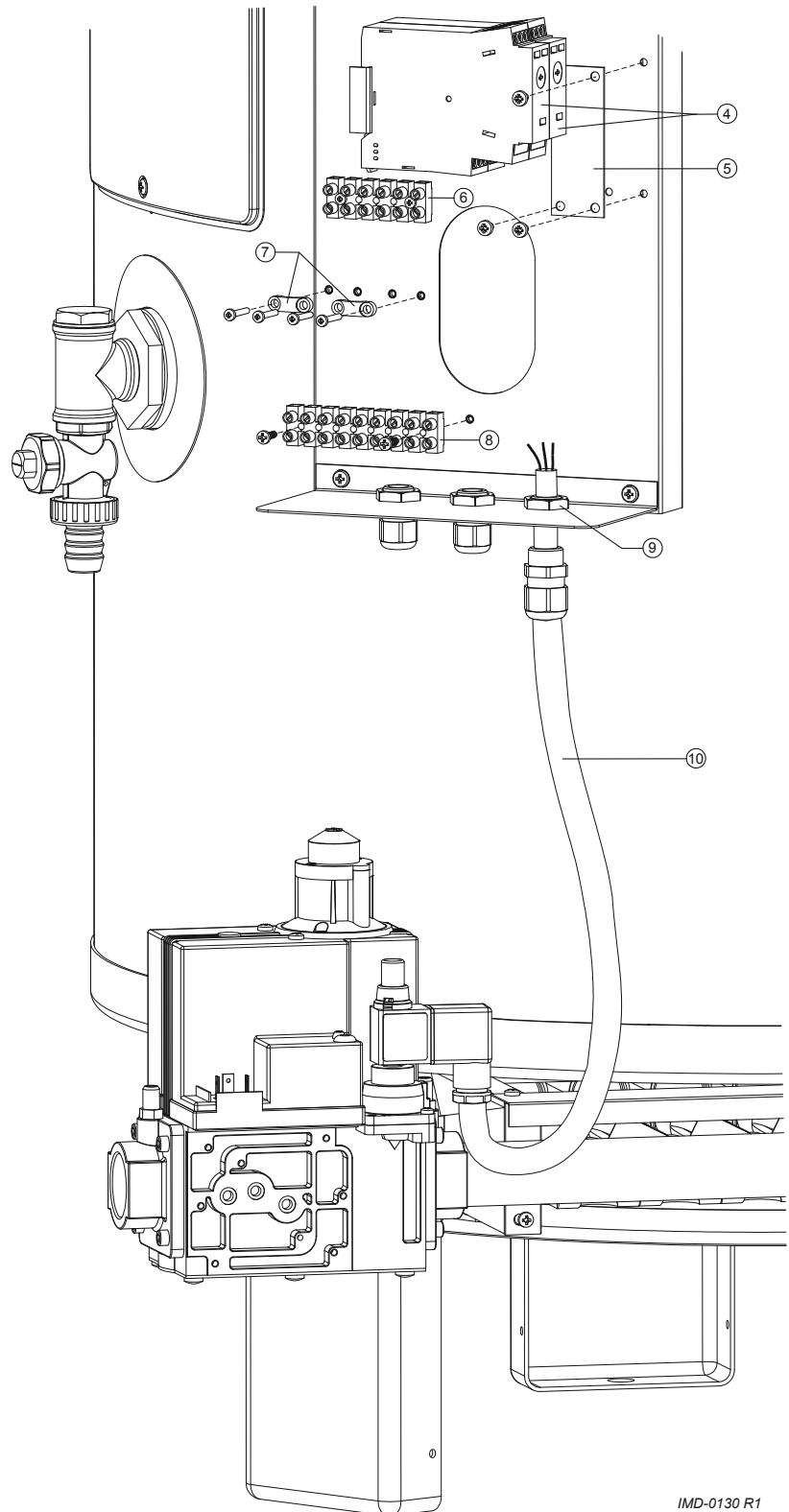

IMD-0130 R1

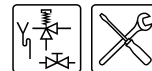

1. Carry out steps 1 through 9 ([4.1 "Conversion to different category ADMR 40 through 115"](#)).
2. Detach the high-low control (9)
3. Fit the burner pressure regulator (1) including the sealing gasket from the conversion set. Attach the burner pressure regulator to the gas control using the two small screws supplied. (7).
4. Detach the leads between the 6contact terminal strip(6) and the 9contact terminal strip (8). These are the leads for the timers, high-low control, gas control, hot surface igniter and flame probe.
5. Remove the timers (4), bracket (5), wiring harness (not shown) and 9contact terminal strip.
6. Turn the metric strain relief (9) with the high-low control lead (10) to loosen it. Remove this lead.
7. Fit the stop plug from the conversion set in the place of the metric strain relief.
8. Connect the cables of the gas control, the hot surface igniter and flame probe to the 6contact terminal strip as indicated in the electrical diagram ([17.2 "Electrical Diagrams ADMR"](#)).
9. Clamp the gas control cable in one of the supplied strain reliefs (7). Do the same for the leads of the hot surface igniter and flame probe.
10. Check the supply pressure and burner pressure ([3.11 "Checking the supply pressure and burner pressure"](#)).
11. Remove the sticker showing the new gas category from the conversion kit, and attach it below the appliance's rating plate. This clearly indicates that the appliance may no longer be run on the gas for which it was originally supplied.
12. Start the appliance ([9.1 "Starting and running"](#)).

#### 4.2.3 Conversion from natural gas to LP gas

1. Carry out steps 1 through 9 ([4.1 "Conversion to different category ADMR 40 through 115"](#)).
2. Detach the burner pressure regulator (1).
3. Fit the high-low controller (9) including the sealing gasket from the conversion set. Attach the high-low control to the gas control using two small screws.
4. Detach the leads from the gas control, the hot surface igniter and the flame probe from the 6contact connector strip (6) and the strain relief (7).
5. Fit the timers (4) including cable harness plus 9contact connector strip (6) from the conversion kit, to the control column.
6. Remove the stop plug (not shown) from the underside of the control column and replace this with the metric strain relief (9) from the conversion kit.
7. Draw the high-low control lead (10) through the strain relief and tighten the strain relief by turning it until the lead is clamped.
8. Connect the high-low control lead (10) plug to the high-low control (9).
9. Connect the cables from the timers, highlow control, gas control and the hot surface igniter as shown in the electrical diagram ([17.2 "Electrical Diagrams ADMR"](#)).
10. Check the supply pressure and burner pressure ([3.11 "Checking the supply pressure and burner pressure"](#)).
11. Remove the sticker showing the new gas category from the conversion kit, and attach it below the appliance's rating plate. This clearly indicates that the appliance may no longer be run on the gas for which it was originally supplied.
12. Start the appliance ([9.1 "Starting and running"](#)).

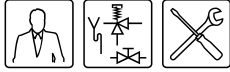

# 5 Filling

## 5.1 Filling the appliance

### 5.1.1 Filling unvented installations

Installation diagram

**Legend**

Only applicable numbers are mentioned.

- 1. pressure reducing valve (mandatory)
- 3. T&P valve
- 4. stop valve (recommended)
- 5. non-return valve (mandatory)
- 6. circulation pump (optional)
- 7. top to bottom circulation pump (optional)
- 9. drain valve
- 10. manual gas valve (mandatory)
- 11. service stop valve (mandatory)
- 12. temperature gauge (recommended)
- 14. hot water draw-off points
- 15. expansion valve (mandatory)
- 16. expansion vessel (mandatory)
- A. cold water supply
- B. hot water supply
- C. circulation pipe
- D. gas supply

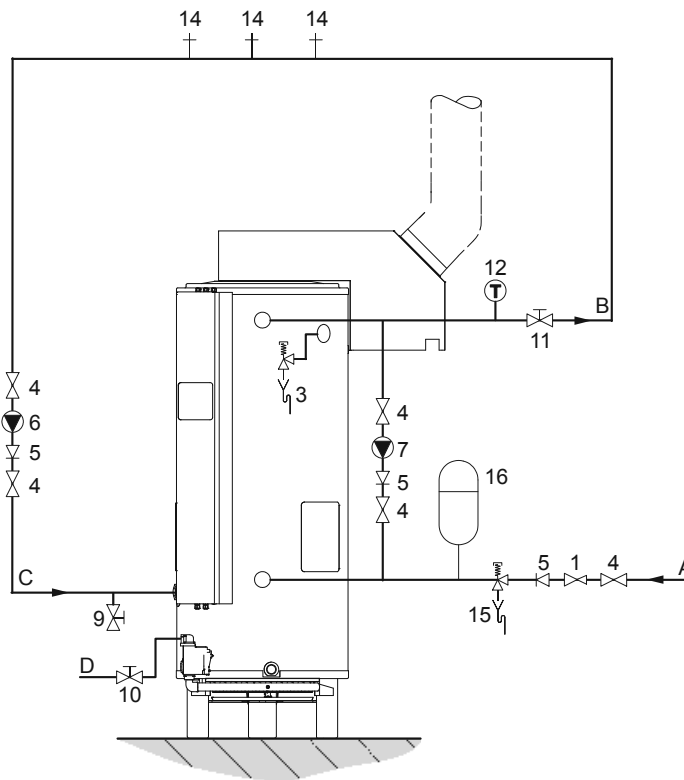

IMD-0142 R2

To fill the appliance, proceed as follows:

1. Open the stop valve (11) in the hot water pipe and, if present, the stop valves (4) for the circulation pump (6).
2. Close the drain valve (9).
3. Open the nearest hot water draw-off point (14).
4. Open the stop valve (4) on the cold water side (A) so that cold water flows into the appliance.
5. Completely fill the appliance. When a full water jet flows from the nearest draw-off point, the appliance is full.
6. Bleed the entire installation of air, for example by opening all draw-off points.
7. The appliance is now under water supply pressure. There should be no water coming out of the expansion valve (15) or out of the T& valve (3). If there is, the cause might be:
  - The T&P valve is defective or incorrectly fitted.
  - The water supply pressure is greater than the specified 8 bar. Rectify this by fitting a pressure reducing valve (1).
  - The expansion valve in the protected cold supply setup is defective or incorrectly fitted.

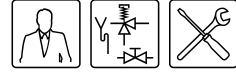

### 5.1.2 Filling vented installations

#### Installation diagram

#### Legend

Only applicable numbers are mentioned.

- 3. T&P valve
- 4. stop valve (recommended)
- 5. non-return valve (mandatory)
- 6. circulation pump (optional)
- 7. top to bottom circulation pump (optional)
- 9. drain valve
- 10. manual gas valve (mandatory)
- 11. service stop valve (mandatory)
- 12. temperature gauge (recommended)
- 14. hot water draw-off points
- 17. 3-way aeration valve (recommended)
- 18. water tank
- 19. float valve
- A. cold water supply
- B. hot water supply
- C. circulation pipe
- D. gas supply
- E. overflow pipe
- H. overflow pipe

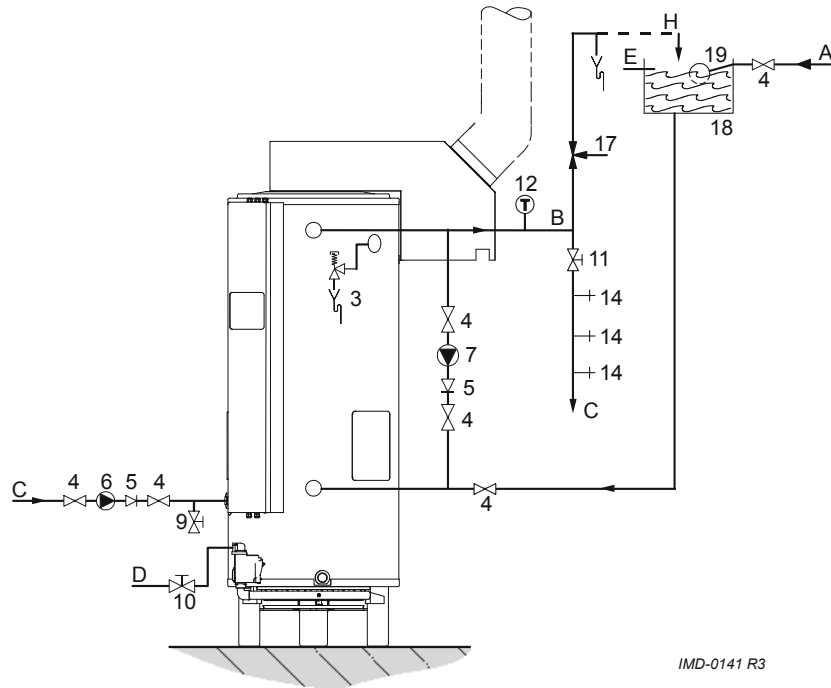

IMD-0141 R3

To fill the appliance, proceed as follows:

1. Open the stop valve (11) in the hot water pipe and, if present, the stop valves (4) for the circulation pump (6).
2. Close the drain valve (9).
3. Open the nearest hot water draw-off point (14).
4. Open the stop valve (4) on the cold water side (A) so that cold water flows into the appliance.
5. Completely fill the appliance. When a full water jet flows from the nearest draw-off point, the appliance is full.
6. Bleed the entire installation of air, for example by opening all draw-off points.
7. The appliance is now under water supply pressure. There should be no water coming out of the T&P valve (3). If this does happen, the T&P valve might be defective or incorrectly fitted.



# 6 Draining

## 6.1 Draining unvented installations

Installation diagram

### Legend

Only applicable numbers are mentioned.

- 1. pressure reducing valve (mandatory)
- 3. T&P valve
- 4. stop valve (recommended)
- 5. non-return valve (mandatory)
- 6. circulation pump (optional)
- 7. top to bottom circulation pump (optional)
- 9. drain valve
- 10. manual gas valve (mandatory)
- 11. service stop valve (mandatory)
- 12. temperature gauge (recommended)
- 14. hot water draw-off points
- 15. expansion valve (mandatory)
- 16. expansion vessel (mandatory)
- A. cold water supply
- B. hot water supply
- C. circulation pipe
- D. gas supply

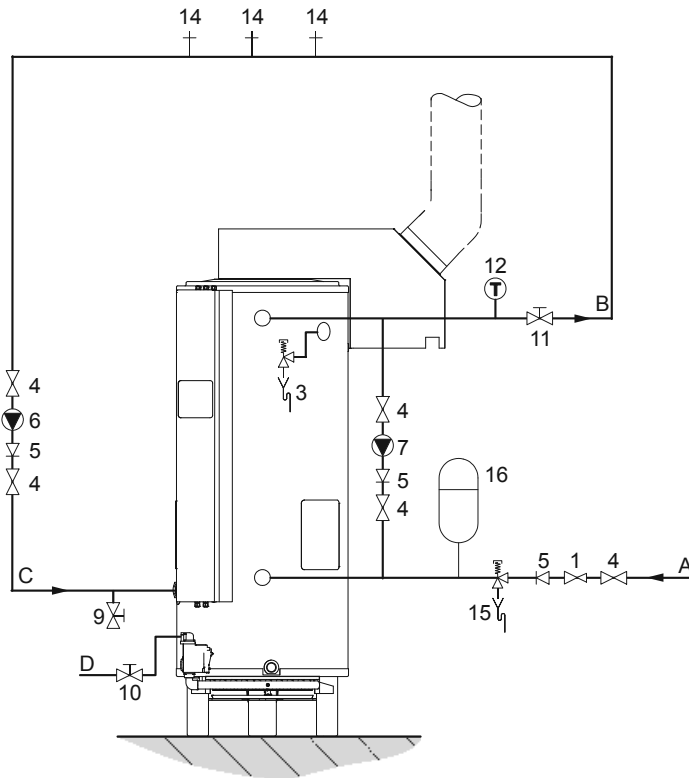

IMD-0142 R2

Some service activities require the appliance to be drained. The procedure is as follows:

1. Activate the MENU with .



2. Position the cursor in front of OFF.
3. Confirm OFF with ENTER.
4. Switch the appliance OFF (position 0) using the ON/OFF switch on the control panel.
5. Isolate the water heater from the power supply by putting the isolator between the appliance and the mains power supply to position 0.
6. Shut off the gas supply (10).
7. Close the stop valve (11) in the hot water pipe.
8. Close the supply valve (4) in the cold water supply (A).
9. Open the drain valve (9).
10. Bleed the appliance (or installation) so that it drains completely.

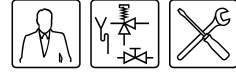

## 6.2 Draining vented installations

Installation diagram

### Legend

Only applicable numbers are mentioned.

- 3. T&P valve
- 4. stop valve (recommended)
- 5. non-return valve (mandatory)
- 6. circulation pump (optional)
- 7. top to bottom circulation pump (optional)
- 9. drain valve
- 10. manual gas valve (mandatory)
- 11. service stop valve (mandatory)
- 12. temperature gauge (recommended)
- 14. hot water draw-off points
- 17. 3-way aeration valve (recommended)
- 18. water tank
- 19. float valve
- A. cold water supply
- B. hot water supply
- C. circulation pipe
- D. gas supply
- E. overflow pipe
- H. overflow pipe

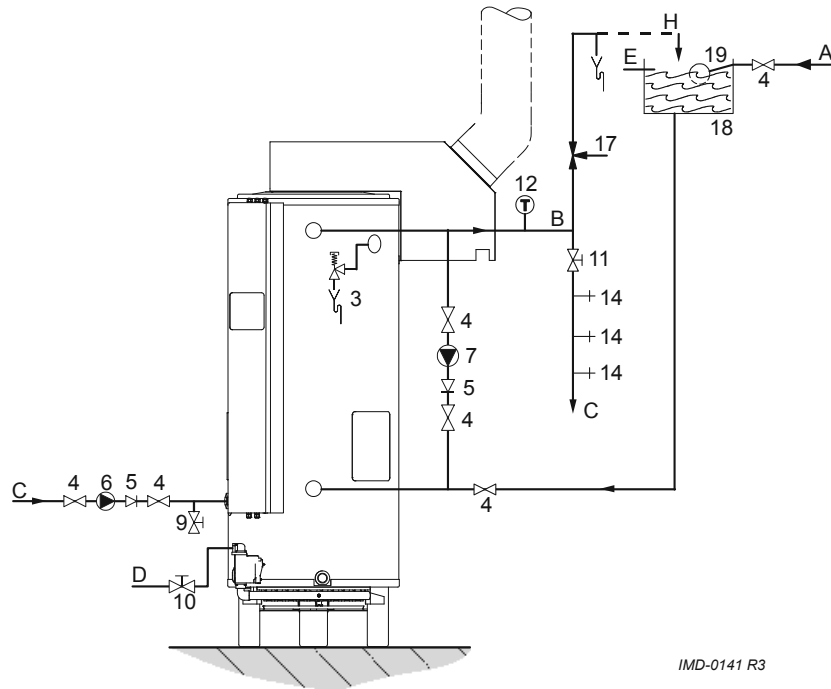

Some service activities require the appliance to be drained. The procedure is as follows:

1. Activate the MENU with .



2. Position the cursor in front of OFF.
3. Confirm OFF with ENTER.
4. Switch the appliance OFF (position 0) using the ON/OFF switch on the control panel.
5. Isolate the water heater from the power supply by putting the isolator between the appliance and the mains power supply to position 0.
6. Shut off the gas supply (10).
7. Close the stop valve (11) in the hot water pipe.
8. Close the stop valve (4) between the water tank and the cold water inlet (A).
9. Open the drain valve (9).
10. Bleed the appliance (or installation) so that it drains completely.

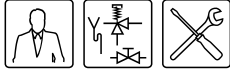

# 7 The control panel

## 7.1 Introduction

Topics covered in this chapter:

- [Controls](#);
- [Explanation of icons](#);
- [Electronic controller ON/OFF switch](#);
- [Navigation buttons](#);
- [PC connection](#).

## 7.2 Controls

The appliance is operated by a menu driven control panel, it consists of:

- a 4-line display with 20 characters per line;
- 6 pushbuttons for operating the appliance (below the display);
- 6 graphical symbols (above the display);
- a connector for a service PC;
- an ON/OFF switch.

The pushbuttons are divided into three groups:

- Navigation buttons:
  - Buttons for UP ↑, and DOWN ↓;
  - Enter: **ENTER**;
  - Reset button: **RESET**
- the main menu (11 "Main menu"):
- the service program (12 "Service program"): . This chapter is specifically intended for the service and maintenance engineer and installation engineer.

In this manual, the display of the electronic controller is shown as in the figure, both with and without icons.

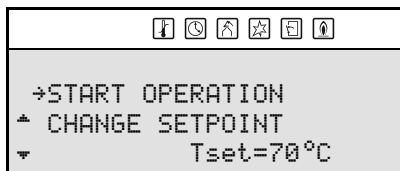

## 7.3 Explanation of icons

The table explains the meanings of the icons.

*Icons and their meaning*

Icon	Name	Explanation
	Heat demand	Heat demand detected
	Waiting time	Waiting time for safe ignition
	Flue damper	The flue damper is open
	Glow	(Pre)glow
	Gas control	Gas control open/ignition
	Flame detection	Appliance operational

## 7.4 Electronic controller ON/OFF switch

The ON/OFF switch of the electronic controller is used to switch the appliance ON and OFF. Note that in the OFF position the appliance remains electrically live, in order for the continuous pump to stay running.

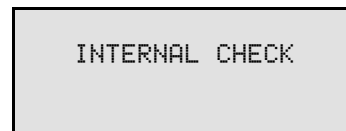

After switching on, the text **INTERNAL CHECK** appears on the display for about 10 seconds. The main menu (11 "Main menu") then appears. If no selection is made in the main menu, the appliance automatically switches to the OFF mode (8.2 "Operating modes").

### Note

To electrically isolate the appliance, you must use the isolator between the appliance and the mains power supply.

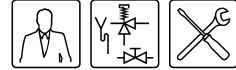

## 7.5 Navigation buttons

The use of these buttons is explained with the help of the figure that shows the main menu (11 "Main menu").

The navigation buttons are:

- Buttons for UP ↑, and DOWN ↓;
- Enter: **ENTER**;
- Reset button: **RESET**.

The ↑ arrows and ↓ indicate that you can scroll up and/or down. Use the buttons ↑ and ↓ to scroll.

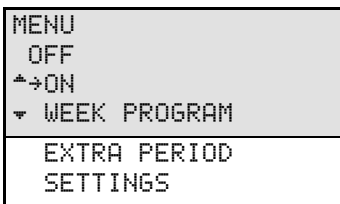

The cursor → points to the option to be activated. In the display as shown in the figure, you can scroll through the main menu.

The main menu comprises: OFF, ON, WEEK PROGRAM, EXTRA PERIOD and SETTINGS. You have to scroll down further to see the options EXTRA PERIOD and SETTINGS.

The selected option is confirmed using **ENTER**.

Pressing the **RESET** button takes you back one page in a menu and discards all options selected in the current menu.



### Note

The **RESET** button is also used to reset the appliance following an error.

## 7.6 PC connection

The PC connection is solely intended to enable technicians from A.O. Smith to display the status and history of the appliance. These details can be important for troubleshooting and/or responding to complaints.





# 8 Status of the appliance

## 8.1 Introduction

Topics covered in this chapter:

- [Operating modes](#);
- [Error conditions](#);
- [Service condition](#).

## 8.2 Operating modes

When running, the appliance has four basic operating modes, namely:

- OFF
- ON
- EXTRA
- PROG

### 8.2.1 OFF

In this mode, the frost protection is activated. The figure shows the display with the following information:

- line one: the text OFF;
- line two: the time, the day and alternately ([2.3 "The appliance's heating cycle"](#))  $T_1$  and  $T_{net}$ ;
- lines three and four: the text FROST PROTECTION ACTIVATED.

```
OFF
13:45 Thursday 6°C
FROST PROTECTION
ACTIVATED
```

### 8.2.2 ON

In this mode, the appliance continually responds to the hot water demand. The figure shows the display with the following information:

- line one: the text ON;
- line two: the time, the day and alternately ([2.3 "The appliance's heating cycle"](#))  $T_1$  and  $T_{net}$ ;
- line three: the programmed water temperature  $T_{set}$ ;
- line four: blank when the appliance is idle, or depending on the heating cycle ([2.3 "The appliance's heating cycle"](#)), displays a text such as HEAT DEMAND

```
ON
13:45 Thursday 67°C
Tset 75°C
```

### 8.2.3 EXTRA

In this mode, one extra period is programmed and activated. In this mode, the OFF or PROG mode is temporarily overruled to fulfil a single period of demand. Once the period has passed, the appliance automatically returns to the previous operating mode. The figure shows the display with the following information:

- line one: the text EXTRA;
- line two: the time, the day and alternately ([2.3 "The appliance's heating cycle"](#))  $T_1$  and  $T_{net}$ ;
- line three: the switch-on time, and the related water temperature setting;
- line four: the text PERIOD ACTIVATED.

```
EXTRA
12:30 Thursday 76°C
TH 12:45 Tset 75°C
PERIOD ACTIVATED
```

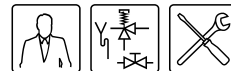

### 8.2.4 PROG

In this mode a preset week program is active, and the appliance responds continually to demand within the time periods set in the week program. There are two distinct situations possible in this mode:

```

PROG
10:00 Monday 76°C
MO 11:15 Tset 75°C
  
```

#### 1. The current time falls within a set time period of the week program.

The figure shows the display with the following information:

- line one: the text PROG;
- line two: the time, the day and  $T_1$  and  $T_{net}$  alternately (2.3 "The appliance's heating cycle");
- line three: the next scheduled switch-off time and the water temperature  $T_{set}$  of the active period;
- line four: is empty, or depending on the heating cycle (2.3 "The appliance's heating cycle"), a text such as HEAT DEMAND.

```

PROG
12:00 Monday 76°C
MO 11:15
PERIOD ACTIVATED
  
```

#### 2. The current time falls outside a set time period of the week program.

The figure shows the display with the following information:

- line one: the text PROG;
- line two: the time, the day and  $T_1$  and  $T_{net}$  alternately (2.3 "The appliance's heating cycle");
- line three: the next scheduled switch-on time;
- line four: displays the text PERIOD ACTIVATED.

In all modes, the temperature may at any moment drop below the desired temperature. The appliance then enters a heating cycle. This heating cycle is identical (2.3 "The appliance's heating cycle") for all basic operating modes.

#### Note

Setting and if necessary programming of the basic operating modes are described in the main menu (11 "Main menu") chapter.

### 8.3 Error conditions

The figure shows an example of an error condition. If the appliance enters this condition, the display will show the following information:

- line one: error code comprising a letter and two digits, followed by the error description;
- lines two to four: alternately, a brief explanation of the error, and a brief action to resolve the error.

```

S04: SENSOR ERROR

CHECK
SENSOR OR DUMMY
  
```

**Caution** The displayed action to resolve the error may only be performed by a service and maintenance engineer.

There are various types of errors:

- LOCK OUT ERRORS  
When the cause has been removed, these errors require a reset with the button RESET before the appliance can resume operation.
- BLOCKING ERRORS  
These errors disappear automatically once the cause of the error has been removed, after which the appliance resumes operation by itself.

The display does not show what type of error has been detected. A comprehensive overview of the errors is provided elsewhere in the manual (13 "Troubleshooting").

If, as end-user, you find the appliance in an error condition, you may attempt to restart the appliance by pressing the RESET button

However, if the error returns or occurs several times in a short time you must contact your service and maintenance engineer.

### 8.4 Service condition

The figure shows the message

```

!!! WARNING !!!

MAX. BURNING HOURS:
SERVICE REQUIRED
  
```

SERVICE REQUIRED. Should this message appear, then the appliance is in need of a service and maintenance inspection. In that case, contact your service and maintenance engineer.

#### Note

The message SERVICE REQUIRED is based on the number of expired burning hours and the preset service interval. Should the service interval have been incorrectly selected, contact the service and maintenance engineer for instructions on how to adjust this. Information on the maintenance frequency is provided elsewhere in the manual (14 "Maintenance frequency").



# 9 Starting and running

## 9.1 Starting and running

Start the appliance as follows:

1. Fill the appliance (5 "Filling").
2. Open (3.5 "Installation diagram") the manual gas valve.
3. Switch on the power to the appliance using the isolator between the appliance and the power supply.
4. Switch the electronic controller **ON** by setting the ON/OFF switch to **position I**.

The display will now show **INTERNAL CHECK** for about 10 seconds and go to the main menu.

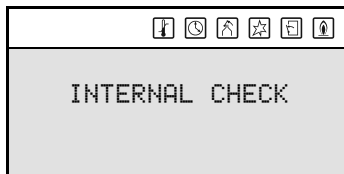

5. Press the blue arrow once (↓) to position the cursor in front of **ON** and press **ENTER**. The display shown in the figure will appear.

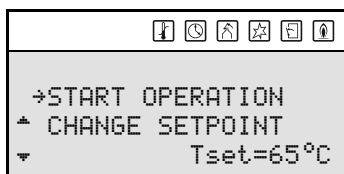

6. Confirm the **START OPERATION** by pressing **ENTER**.

The appliance is now in "ON mode". If there is a heat demand, the appliance will run through the heating cycle (2.3 "The appliance's heating cycle").

If the heating cycle is not run, there is no heat demand; if this is the case, Tset will probably need to be set (11.3 "Setting the water temperature").

## 9.2 The appliance's heating cycle

The appliance's heating cycle is activated as soon as the measured water temperature ( $T_{net}$ ) falls below the threshold value ( $T_{set}$ ). This threshold value depends on the currently selected appliance operating mode. For example, if the appliance is in "OFF mode" (frost protection), then this value is 5 °C. If the appliance is in "ON mode", then this threshold value is selectable, for example, 65 °C.

The heating cycle runs in turn through the following states:

1. HEAT DEMAND
2. WAITING TIME
3. FLUE DAMPER
4. PRE-GLOW
5. IGNITION
6. RUNNING
7. WAITING TIME

The complete cycle is explained in the following example, which assumes the appliance is in the basic mode ON.

### Note

The same heating cycle applies to the other operating modes.

Once the appliance starts, it will run through the following steps:

1. The water temperature drops below the set temperature of (for example) 65 °C. The electronic controller detects a demand and starts the heating cycle.
  - The icon is activated.
  - The message **HEAT DEMAND** appears.

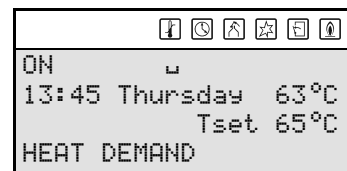

2. Following demand, the waiting time starts. The waiting time lasts approximately 12 seconds.
  - The icon is activated.
  - The message **WAITING TIME** appears.

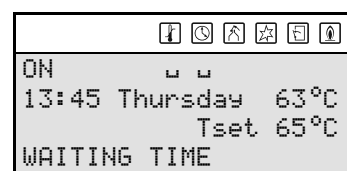

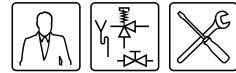

3. During the waiting time, the flue damper opens.
  - The icon is activated.
  - The message **FLUE DAMPER** appears.

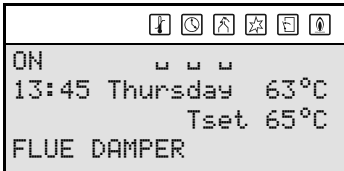

4. After the flue damper opens, the text **GLOW PLUG** appears on the display. This is followed by the (pre-)glow of the hot surface igniter.
  - The icon is dimmed.
  - The icon is activated.

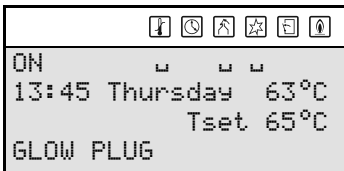

5. After a number of seconds pre-glow, the gas control is opened and ignition takes place.
  - The icon is activated.
  - The message **IGNITION** appears.

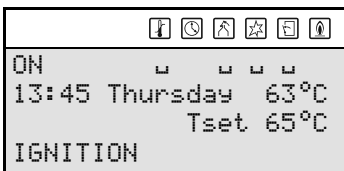

6. After ignition, the flame is detected and the appliance will be running. This means that actual heating has started:
  - The icon is dimmed.
  - The icon is activated.
  - The message **RUNNING** appears.

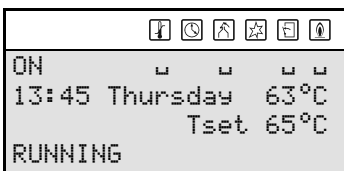

7. When the water reaches the set temperature, the demand ceases. The flue damper and gas control both close and the burner tray is extinguished. A new waiting time of about 10 seconds starts.
  - The icons , , and , are dimmed.
  - The icon is activated.
  - The message **WAITING TIME** appears.

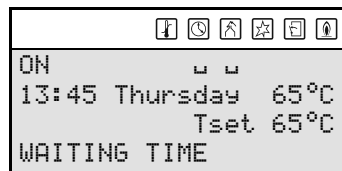

8. After the waiting time, the appliance enters an idle state:
  - The icon is dimmed.
  - The message **WAITING TIME** disappears.
  - With any subsequent heat demand, the heating cycle will resume from step 1.

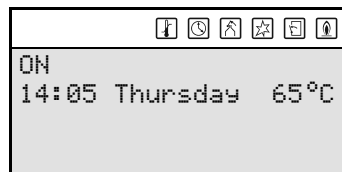



# 10 Shutting down

## 10.1 Introduction

This chapter describes:

- Shut the appliance down for a brief period ("OFF mode");
- Electrically isolating the appliance;
- Shutting the appliance down for a long period;
- Disposal.

## 10.2 Shut the appliance down for a brief period ("OFF mode")

To shut the appliance down for a brief period, you must activate the frost protection.

You can use the frost protection to prevent water freezing in the appliance.

Activate the frost protection as follows:

1. Press the button to select the main menu.
2. Use and to position the cursor in front of OFF. Confirm with ENTER.

```
OFF
13:45 Thursday 6°C
FROST PROTECTION
ACTIVATED
```

The frost protection cuts in if the water temperature drops below 5 °C. The text FROST will then appear on line one of the display. The appliance heats the water to 20 °C (T<sub>set</sub>) and drops back to the OFF mode.

### Note

These values of 5 °C and 20 °C cannot be adjusted.

## 10.3 Electrically isolating the appliance

The appliance should only be isolated from mains power in the correct way. The correct procedure is as follows:

1. Activate the MENU with .
2. Position the cursor in front of OFF.
3. Confirm OFF with ENTER.

```
MENU
→OFF
▲ ON
▼ WEEK PROGRAM
```

### Caution

Failure to wait until the fan stops purging can cause damage to the appliance.

4. Wait until the fan has stopped. The symbol is then dimmed.
5. Switch the appliance **OFF (position 0)** using the ON/OFF switch on the control panel.
6. Isolate the appliance from the power supply by setting the isolator between the appliance and the mains power supply to position 0.

## 10.4 Shutting the appliance down for a long period

Drain the appliance if you are shutting it down for a long period. Proceed as follows:

1. Isolate the appliance from the power supply (10.3 "Electrically isolating the appliance").
2. Shut off the gas supply.
3. Close the stop valve in the hot water pipe.
4. Open the drain valve
5. Bleed the appliance (or installation) so that it drains completely.

## 10.5 Disposal

Old end-of-life appliances contain materials that need to be recycled. When disposing of old devices that have reached the end of their service life, you should take account of local legislation relating to waste disposal.

You must therefore never dispose of your old appliance together with regular waste, but should and it into a municipal waste collection depot for electrical and electronic equipment. Ask your dealer/installation engineer for advice if necessary. The old appliance must be stored out of reach of children.

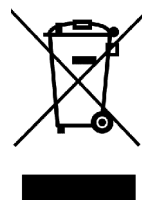

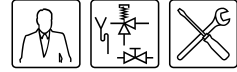



# 11 Main menu

## 11.1 Notational convention for menu-related instructions

The MENU (☰) of the electronic controller is divided into submenus. For example, SETTINGS is one of the functions reached from the main menu. The SETTINGS menu is divided into submenus in turn. For example, LANGUAGE is a submenu of SETTINGS. So, for example, to select the LANGUAGE menu, this manual uses the following notational convention:

- ☰ : SETTINGS | LANGUAGE  
Confirm with ENTER.

This means:

- ☰ : Activate the main menu with ☰.
- SETTINGS : Use the ↑ and/or ↓ buttons to go to SETTINGS and confirm with ENTER.
- LANGUAGE : Use the ↑ and/or ↓ buttons to go to LANGUAGE
- Confirm with ENTER. After entering ENTER, you will have activated the LANGUAGE submenu.

## 11.2 Switching on the "ON mode"

You can switch the appliance to the ON mode from any operational mode, as follows:

- ☰ : ON | START OPERATION  
Confirm with ENTER.

**Note**  
First consult the chapter about switching on (9 "Starting and running") too.

## 11.3 Setting the water temperature

### 11.3.1 Setting the water temperature via the SET POINT MENU

The water temperature can be set to any value between 40 °C and 80 °C.

Set the water temperature via:

- ☰ : ON | CHANGE SETPOINT  
Confirm with ENTER.

```
START OPERATION
^→CHANGE SETPOINT
▼          Tset=65°C
```

2. Use:

- ↑ to increase the value;
- ↓ to decrease the value.
- Confirm with ENTER. After confirming, the appliance enters "ONmode".

```
SETPOINT
      → 65°C
```

**Note**  
If the preset temperature is higher than the current water temperature, then the appliance might **not** immediately start the heating cycle. To prevent excessively frequent switching on and off, there is a heating margin. The standard setting for this margin is 4 °C. The appliance starts heating when the water temperature is 4 °C colder than the SETPOINT. We refer to this margin as the hysteresis. The service and maintenance engineer can adjust (12.2 "Setting the hysteresis") this setting.

### 11.3.2 Setting water temperature during ON mode

The water temperature can also be directly adjusted when the appliance is in the "ON mode". Simply use:

- ↑ to increase the value;
- ↓ to decrease the value.
- Confirm with ENTER.

```
ON
13:45 Thursday 65°C
      Tset→65°C
```

## 11.4 Week program

Using the week program, you can set the water temperature for the days and times you want.

If the appliance is running under a week program, this is indicated on the display by the PROG text on the first line (see the figure). The second line shows the time of day, the day of the week and the temperature. The third line shows the next switching time of the week program and the programmed temperature. The fourth line shows the PROGRAM ACTIVATED text.

```
PROG
07:55 Monday   64°C
MO 08:00      Tset 75°C
PROGRAM ACTIVATED
```

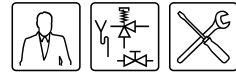

The appliance's default week program switches the appliance on every day at 00:00 and off at 23:59. The default water temperature setting is 65 °C.

If you want, you can change every setting in the appliance's standard week program.

If the water temperature becomes too low while the week program is running, the appliance will run through the heating cycle (9.2 "The appliance's heating cycle") and return to the week program.

This following are discussed:

- [Starting and stopping the week program;](#)
- [Changing the appliance's standard week program;](#)
- [Adding times to a week program;](#)
- [Deleting times from a week program.](#)

### 11.4.1 Starting and stopping the week program

The week program can be started up from any other operating mode, as follows:

1. : WEEK PROGRAM | START OPERATION  
Confirm with ENTER.

A week program can be shut down simply by activating a different operating mode, for example the "ON mode".

### 11.4.2 Changing the appliance's standard week program

#### Note

First fill-in the desired week program on the supplied week program card.

A week program is made up of a number of programmable periods in which you can have the appliance switch on and off. A period consists of:

- switch-on time: day of the week, hours and minutes;
- switch-off time: hours and minutes;
- the water temperature setting;
- on/off setting for a program-controlled pump.

#### Note

The switch-off time must always be followed by a switch-off time on the same day of the week. A maximum of **three** periods may be programmed per day. You can program a maximum of **21** periods.

Call up the menu for the week program as follows:

1. : WEEK PROGRAM | PROGRAM OVERVIEW.  
Confirm with ENTER.

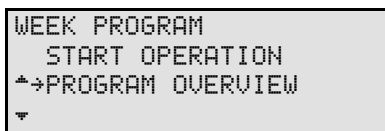

The display shows the menu for the week program, see the figure below. With the default setting, the program switches on and off every day at 00:00 and 23:59 hours respectively, the water temperature is 65 °C and the pump is switched on (F).

DAY	TIME	Tset
ON →SU	00:00	65°C P
OFF SU	23:59	
ON MO	00:00	65°C P
OFF MO	23:59	
ON TU	00:00	65°C P
OFF TU	23:59	
ON WE	00:00	65°C P
OFF WE	23:59	
ON TH	00:00	65°C P
OFF TH	23:59	
ON FR	00:00	65°C P
OFF FR	23:59	
ON SA	00:00	65°C P
OFF SA	23:59	
INSERT		
DELETE		
START OPERATION		

#### Example

As an example, we will set the switch-on time for Sunday to 08:15 hours, and the matching switch-off time to 12:45 hours. The water temperature will be set to 75 °C and the pump will run continuously. The following settings are entered one by one via the menu: the switch-on time, the switch-off time, the desired water temperature, and the mode of the program-controlled pump.

#### Week program: setting the switch-on time

1. Bring the cursor to SU  
Confirm with ENTER.

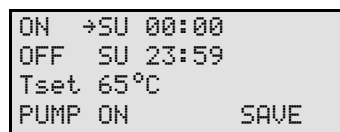

The day indicated by → flashes.

2. Use ↑ and ↓ to set the desired day. In the example this is SU (Sunday).

Confirm with ENTER.

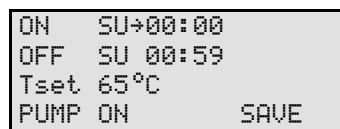

The cursor moves to the hour digits, which flash.





- Use **↑** and **↓** to set the hours. In the example, this is 08.

Confirm with **ENTER**.

The cursor moves to the minute digits, which flash.

```
ON  SU 08:00
OFF SU 08:00
Tset 65°C
PUMP ON      SAVE
```

#### Note

Because the switch-off time can never be earlier than the switch-on time, the switch-off time setting is automatically adjusted with the switch-on time.

- Use **↑** and **↓** to set the minutes. In the example, this is 15.

Confirm with **ENTER**.

The cursor moves to the switch-off hour digits, which flash.

```
ON  SU 08:15
OFF SU→08:15
Tset 65°C
PUMP ON      SAVE
```

#### Week program: setting the switch-off time

- Use **↑** and **↓** to set the hours. In the example, this is 12.

Confirm with **ENTER**.

The cursor moves to the minute digits, which flash.

```
ON  SU 08:15
OFF SU 12:15
Tset 65°C
PUMP ON      SAVE
```

- Use **↑** and **↓** to set the minutes. In the example, this is 45.

Confirm with **ENTER**.

The cursor moves to the desired water temperature.

```
ON  SU 08:15
OFF SU 12:45
Tset→65°C
PUMP ON      SAVE
```

#### Week program: setting the water temperature

- Use **↑** and **↓** to set the water temperature. In the example this is 75 °C.

Confirm with **ENTER**.

The cursor moves to PUMP ON

```
ON  SU 08:15
OFF SU 12:45
Tset 75°C
PUMP→ON      SAVE
```

#### Week program: setting the program-controlled pump

- If required, a pump can be controlled during the period. Use **↑** and **↓** to set PUMP ON . The pump ensures a regular circulation of hot water in the hot water pipes. You can skip this step if you there is no pump in your hot water circuit.

Confirm with **ENTER**.

The cursor moves to SAVE.

```
ON  SU 08:15
OFF SU 12:45
Tset 75°C
PUMP→ON      SAVE
```

- Confirm with **ENTER**.

The display shown in the figure will appear.

DAY	TIME	Tset
ON →SU	08:15	75°C P
OFF SU	12:45	
ON MO	00:00	65°C P
OFF MO	23:59	
ON TU	00:00	65°C P
OFF TU	23:59	

- If you wish, you can use **↓** to scroll to another day, and change more switch-on times ("Week program: setting the switch-on time") and switch-off times ("Week program: setting the switch-off time").

- After changing all desired switch-on and switch off times, you can start running the week program:

Scroll with **↓** to START OPERATION.

Confirm with **ENTER**.

#### 11.4.3 Adding times to a week program

Call up the menu to INSERT switch-on and switch-off times into a week program as follows:

- ☰**: WEEK PROGRAM | PROGRAM OVERVIEW.

Confirm with **ENTER**.

```
WEEK PROGRAM
START OPERATION
↵PROGRAM OVERVIEW
▼
```

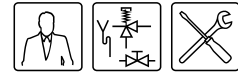

The display shows the menu for the week program. The cursor points to the active period.

```

DAY TIME  Tset
ON →SU  08:15 75°C P
OFF SU   12:45
ON  MO   00:00 65°C P
.....
.....
OFF SA  23:59
  INSERT
  DELETE
  START OPERATION
    
```

2. Scroll ↓ to INSERT.

Confirm with ENTER.

The sub-menu for adding a period will appear.

```

ON →SU  08:15
OFF SU   12:45
Tset 75°C
PUMP ON      SAVE
    
```

**Example**

As an example, we will program an extra period in which the switch-on time is set to 18:00 hours, and the corresponding switch-off time to 22:00 hours. The water temperature will be set to 75 °C and the pump will run continuously.

```

DAY TIME  Tset
ON →SU  18:00 75°C P
OFF SU   22:00
ON  MO   00:00 65°C P
OFF MO   23:59
.....
.....
OFF SA  23:59
  INSERT
  DELETE
  START OPERATION
    
```

3. Proceed as follows:

- Set the switch-on time ("Week program: setting the switch-on time").
- Set the switch-off time ("Week program: setting the switch-off time").
- Set the water temperature ("Week program: setting the water temperature").
- Set the program-controlled pump ("Week program: setting the program-controlled pump").

4. To activate the week program with the new period added, scroll down with ↓ to START OPERATION and confirm with ENTER.

**11.4.4 Deleting times from a week program**

All switch-on/off times are shown sequentially in the display. Assume that the switch-on/off times for the appliance are programmed as in the figure.

```

DAY TIME  Tset
ON →SU  08:15 75°C P
OFF SU   12:45
ON  SU   18:00 75°C P
OFF SU   22:00
.....
.....
OFF SA  23:59
  INSERT
  DELETE
  START OPERATION
    
```

To delete a period, proceed as follows:

1. : WEEK PROGRAM | PROGRAM OVERVIEW.

Confirm with ENTER.

```

MENU
OFF
↵→ON
⇩ WEEK PROGRAM
    
```

2. Scroll with ↓ to PROGRAM OVERVIEW.

Confirm with ENTER.

```

WEEK PROGRAM
START OPERATION
↵→PROGRAM OVERVIEW
⇩
    
```

The display shows the menu for the week program.

3. Scroll with ↓ to DELETE.

Confirm with ENTER.

To warn you that you are now working in the delete sub-menu, the cursor is replaced with an exclamation mark (!) and the period settings flash.

```

DAY TIME  Tset
ON !SU  08:15 75°C P
OFF SU   12:45
ON  SU   18:00 75°C P
OFF SU   22:00
.....
.....
OFF SA  23:59
  INSERT
  DELETE
  START OPERATION
    
```

4. Scroll with ↓ to the day to be deleted. For example, SU (Sunday) in the second period. See the figure.



Confirm with **ENTER**.

```

DAY TIME Tset
ON !SU 18:00 75°C P
OFF SU 22:00
ON MO 00:00 65°C P
OFF MO 23:59
.....
OFF SA 23:59
INSERT
DELETE
START OPERATION
  
```

- The lines showing switch-on/off times are replaced by the text **DELETE BLOCK?**. See the figure.

Confirm with **ENTER**.  
(or use **RESET** to cancel)

```

DAY TIME Tset
ON ! DELETE
OFF BLOCK?
ON MO 00:00 65°C P
  
```

The switching period has been deleted. You will return now to the week program menu. The cursor points to the first programmed period.

```

DAY TIME Tset
ON →SU 08:15 75°C P
OFF SU 12:45
ON MO 00:00 65°C P
OFF MO 23:59
.....
OFF SA 23:59
INSERT
DELETE
START OPERATION
  
```

- Scroll with **↓** to **START OPERATION**.

Confirm with **ENTER**.  
The week program is active.

### 11.5 Extra period

Use an extra period when you either want to have the appliance switch on and off for a certain period, either without modifying the active week program, or without taking the appliance out of the OFF mode (frost protection active).

If the appliance is running under an "extra period", then this is indicated in the display with the text **EXTRA**.

```

EXTRA
10:00 Monday 76°C
MO 11:15 Tset 75°C
PERIOD ACTIVATED
  
```

If the water temperature becomes too low during the extra period (11.5.1 "Programming an extra period"), the appliance will run through the heating cycle (9.2 "The appliance's heating cycle") and fall back into the extra period.

The same settings can be made for an extra period as for a week program (11.4.2 "Changing the appliance's standard week program") period.

#### 11.5.1 Programming an extra period

- Call up the menu for entering an extra period via:
- : EXTRA PERIOD

Confirm with **ENTER**.

```

MENU
ON
↑ WEEK PROGRAM
↔ EXTRA PERIOD
  
```

The display show the settings for the extra period.

#### Setting the switch-on time

- Use **↑** and **↓** to set the day. In the example this is **SU**.

Confirm with **ENTER**.

The cursor moves to the hour digits, which flash.

```

ON SU→00:00
OFF SU 00:59
Tset 65°C
PUMP ON START
  
```

- Use **↑** and **↓** to set the switch-on hour to the desired value. In the example, this is **08**.

Confirm with **ENTER**.

The cursor moves to the minute digits, which flash.

```

ON SU 08→00
OFF SU 08:00
Tset 65°C
PUMP ON START
  
```

#### Note

Because the switch-off time can never be earlier than the switch-on time, the switch-off time setting is automatically adjusted with the switch-on time.

- Use **↑** and **↓** to set the minutes. In the example, this is **15**.

Confirm with **ENTER**.

The cursor moves to the hour digits of the switch-off period.

```

ON SU 08:15
OFF SU→08:15
Tset 65°C
PUMP ON START
  
```

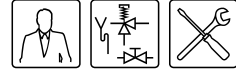

### Setting the switch-off time

1. Use **↑** and **↓** to set the hours. In the example, this is 08:15.

Confirm with **ENTER**.

The cursor moves to the minute digits, which flash.

```
ON   SU 08:15
OFF  SU 12:15
Tset 65°C
PUMP ON      START
```

2. Use **↑** and **↓** to set the minutes. In the example, this is 45.

Confirm with **ENTER**.

The cursor moves to the water temperature. See the figure

```
ON   SU 08:15
OFF  SU 12:45
Tset→65°C
PUMP ON      START
```

### Setting the water temperature

1. Use **↑** and **↓** to set the water temperature. In the example this is 75 °C.

Confirm with **ENTER**.

The cursor moves to PUMP ON

```
ON   SU 08:15
OFF  SU 12:45
Tset 75°C
PUMP→ON START
```

### Setting the program-controlled pump

1. If required, a pump can be controlled during the period. Use **↑** and **↓** to set PUMP ON. The pump ensures a regular circulation of hot water in the hot water pipes. You can skip this step if you there is no pump in your hot water circuit.

Confirm with **ENTER**.

The cursor moves to START.

```
ON   SU 08:15
OFF  SU 12:45
Tset 75°C
PUMP ON →START
```

2. Confirm with **ENTER**.

The extra period has been programmed.

#### Note

Once the extra period has completed running, the controller returns to the mode ON, OFF or WEEK PROGRAM. The following week, the extra period will **NOT** be automatically switched on.

## 11.6 Settings

Using the **SETTINGS** option, you can adjust certain settings and read certain appliance data:

- **Adjustable settings**
  - Language of the menu.
  - Current day of week and time.
- **Displayable appliance specifications**, this category is only relevant to the installation engineer and/or service and maintenance engineer
  - Control range (water temperature).
  - Ignition speed of fan.
  - Working speed of fan.

### 11.6.1 Setting menu language

To set menu language:

```
MENU
WEEK PROGRAM
▲ EXTRA PERIOD
▼→SETTINGS
```

1. Call up the menu for selecting the language as follows:

2. **↵** : SETTINGS.

Confirm with **ENTER**.

The display shows the menu for settings.

```
SETTINGS
→LANGUAGE
▲ DAY/TIME
▼ SPECIFICATIONS
```

3. The cursor is positioned beside LANGUAGE

Confirm with **ENTER**.

The display shows the language selection menu.

```
LANGUAGE
ENGLISH
▲ NEDERLANDS
▼→DEUTSCH

FRANCAIS
ITALIANO
CZECH
ESPANOL
```

4. Scroll with **↓** to the desired language.

Confirm with **ENTER**.

The language is set.



## 11.6.2 Setting day and time

To enter the time and day:

```
MENU
WEEK PROGRAM
^ EXTRA PERIOD
v->SETTINGS
```

1. Call up the menu for entering the day and time as follows:
2. : SETTINGS.  
Confirm with **ENTER**.  
The display shows the menu for settings.
3. Scroll with **↑** and **↓** to DAY/TIME  
Confirm with **ENTER**.

```
SETTINGS
LANGUAGE
^>DAY/TIME
v SPECIFICATIONS
```

The display shows the sub-menu for adjusting the day.

```
DAY
->Sunday
^ Monday
v Tuesday
Wednesday
Thursday
Friday
Saturday
```

4. The cursor is positioned beside *Sunday*.  
Scroll with **↑** and **↓** to the desired day.  
Confirm with **ENTER**.  
The day has been set. The display shows the sub-menu for adjusting the time.

```
TIME
->00:00
```

5. The cursor moves to the hour digits, which flash.  
Scroll with **↑** and **↓** to the current hour, for example 15.  
Confirm with **ENTER**.

```
TIME
15->00
```

6. The cursor moves to the minute digits, which flash.  
Scroll with **↑** and **↓** to the next minute, for example 45.

Confirm the minute setting with **ENTER**

```
TIME
15->45
```

The time has been set.

**Note**  
The appliance takes no account of daylight saving.

## 11.6.3 Displaying appliance specifications

**Note**  
This category is solely intended for the installation engineer and/or service and maintenance engineer.

The table shows the standard settings for the appliance specifications.

*Appliance specifications*

	<b>ADMR 40 - 135</b>
<b>Regulation interval</b>	40 - 80 °C
<b>Flue gas safety</b>	75 °C

Call up the menu to display the appliance specifications as follows:

1. : SETTINGS.  
Confirm with **ENTER**.

```
MENU
WEEK PROGRAM
^ EXTRA PERIOD
v->SETTINGS
```

2. Scroll with **↓** to SPECIFICATIONS  
Confirm with **ENTER**.

```
SETTINGS
LANGUAGE
^ DAY/TIME
v->SPECIFICATIONS
```

The display shows the sub-menu for displaying appliance specifications.

```
SPECIFICATIONS
->REGULATION INTERVAL
FLUE GAS SAFETY
```

3. Scroll with **↓** to the section to be displayed, for example **REGULATION INTERVAL**  
The relevant display appears

```
REGULATION INTERVAL
40-80°C
```

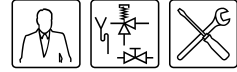

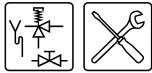

# 12 Service program

## 12.1 Introduction

The service program is used by the installation engineer or service and maintenance engineer for:

- Setting the hysteresis;
- Displaying the error history;
- Displaying the appliance history;
- Display the selected appliance;
- Switching the pump on or off;
- Setting the service interval;
- Setting the display contrast;
- Setting the display backlight time;
- Setting the display scroll speed.

```
SERVICE MENU
→HYSTERESE
← HISTORY OF ERRORS
▽ APPLIANCE HISTORY

SELECT APPLIANCE
PUMP RELAY
SERVICE INTERVAL
CONTRAST DISPLAY
TIME BACKLIGHT
SCROLLSPEED
```

These sub-menus are briefly described in the following paragraphs. If you are not familiar in general with how to use the displays and menus, first read the relevant section (7 "The control panel").

### Note

The notation convention for the service menu is identical to that of the main menu (11.1 "Notational convention for menu-related instructions"). The difference is, you use  $\rightarrow$  to bring up the service program, instead of  $\leftarrow$  which brings up the main menu.

## 12.2 Setting the hysteresis

If the preset temperature (SETPOINT) is higher than the current water temperature, then the appliance might **not** immediately start the heating cycle (9.2 "The appliance's heating cycle"). To prevent excessively frequent switching on and off, there is a heating margin. We refer to this margin as the

hysteresis. The standard setting for this margin is 2 °C. The heating cycle starts if the water temperature drops to 2 °C below the SETPOINT and ends when the water reaches 2 °C above the SETPOINT.

```
HYSTERESE UP →3°C
```

Set the hysteresis via:

- $\rightarrow$ : HYSTERESE UP

The figure shows an example

Set the hysteresis via:

- $\rightarrow$ : HYSTERESE DOWN

## 12.3 Displaying the error history

Display the error history as follows:

- $\rightarrow$ : HISTORY OF ERRORS

The controller will display an overview of "Blocking errors" and "Lock out errors". In both cases, the electronic controller reserves 15 lines for the last 15 error messages. If there are fewer than 15 error messages, an ellipsis (...) is displayed. The display first shows the "Blocking errors". When ENTER is pressed, the "Lock out errors" are then displayed.

The figure shows an example of "Blocking errors". In this case, the text HISTORY OF ERRORS is followed by (B).

```
HISTORY OF ERRORS(B)
S04 SENSOR ERROR
F06 IONIZATION
▽ C02 50 HZ ERROR
```

The figure shows an example of "Lock out errors". In this case, the text HISTORY OF ERRORS is followed by (L).

```
HISTORY OF ERRORS(L)
F02 FAN
F07 FLAME ERROR
▽ ...
```

### Note

For an overview of all errors and the possible causes, please refer to the relevant chapter (13 "Troubleshooting").

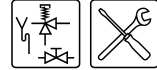

## 12.4 Displaying the appliance history

The appliance history submenu is used to display the burning hours, the number of ignitions, the number of flame errors and the number of ignition errors.

Call up the menu for displaying the appliance history as follows:

- $\Rightarrow$ : APPLIANCE HISTORY  
The figure shows an example.

```

APPLIANCE HISTORY
BURNINGHOURS 000410
^IGNITIONS   001000
vFLAME ERRORS 000021
IGNIT ERROR  000013
  
```

## 12.5 Display the selected appliance

Call up the menu for displaying the appliance selection as follows:

- $\Rightarrow$ : SELECT APPLIANCE  
The appliance number can be found on the rating plate.  
The appliance selection has been correctly preset in the factory.

```

SELECT APPLIANCE
+5934
^ 8576
v 3379
6527
....
  
```

## 12.6 Switching the pump on or off

If a program-controlled pump is installed (3.6.2 "Recirculation pipe"), it can be switched ON or OFF as follows:

- $\Rightarrow$ : PUMP RELAY  
The standard setting for the pump relay is OFF.

```

PUMP RELAY
+ON
OFF
  
```

If the mode WEEK PROGRAM or EXTRA PERIOD is active, then the setting for mode WEEK PROGRAM or EXTRA PERIOD has priority over the ON/OFF selection for the pump relay in the service menu.

### Example

*One of the week program periods is currently active. During this period, the pump relay setting is OFF. If the pump relay is set ON in the service menu, the pump will nonetheless remain OFF. The pump will only switch ON once the week program period has ended.*

## 12.7 Setting the service interval

To aid servicing, the electronic controller includes a service interval which is used to set the frequency of maintenance interval (14.2 "Determining service interval") by the service and maintenance engineer, based on the number of burning hours.

The service interval is based on the number of burning hours. This can be set to 500, 1000 and 1500 hours. The standard setting for number of hours is **500**. Once the preset number of hours is reached, a message (8.4 "Service condition"), to this effect will appear. Adjust the service interval via:

- $\Rightarrow$ : SERVICE INTERVAL

```

SERVICE INTERVAL
+ 500
^ 1000 BURNING HOURS
v 1500
  
```

## 12.8 Setting the display contrast

Adjust the display contrast via:

- $\Rightarrow$ : CONTRAST DISPLAY  
The standard setting is 100%. The range is from 0 through 100%.  
The figure shows the related display.

```

CONTRAST DISPLAY
+ 95%
  
```

## 12.9 Setting the display backlight time

Set the backlight time (the time that the display backlight remains lit after the last button is pressed) as follows:

- $\Rightarrow$ : TIME BACKLIGHT  
The standard value is 255 s. The range is 0 to 255 seconds.  
The figure shows the related display.

```

TIME BACKLIGHT
+ 255 sec
  
```

## 12.10 Setting the display scroll speed

Adjust the control speed via:

- $\Rightarrow$ : SCROLLSPEED  
The default is 10. The range is from 0 through 100. Setting the value too high or low will make scrolling difficult.

```

SCROLLSPEED
+ 10
  
```



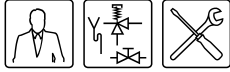

# 13 Troubleshooting

## 13.1 Introduction

A distinction is made between:

- **General errors**

General errors are not reported on the display. General errors are:

- Gas smell;
- Display does not light up;
- Insufficient or no hot water;
- Water leakage;
- Explosive ignition.

The manual includes a table with general errors ([13.2 "Troubleshooting table for general errors"](#)).

- **Displayed errors**

Errors are reported on the display, as follows:

- Line one: an error code and a brief description. The code consists of a letter and two digits.
- Lines two, three and four: a long description, alternating with a recommended action. See the figures. The first shows a possible error, the second shows the appropriate checking action.

```
S02: SENSOR ERROR
      TOP TANK
      SENSOR 1
      NOT CONNECTED
```

```
S02: SENSOR ERROR
      CHECK TOP TANK
      SENSOR
```

There are various types of errors, all falling into one of two groups:

- **LOCK OUT ERRORS**  
When the cause has been removed, these errors require a reset with the **RESET** button, before the appliance can resume operation.
- **BLOCKING ERRORS**  
These errors disappear automatically once the cause of the error has been removed, after which the appliance resumes operation by itself.

The manual includes a table of error messages that can appear on the display ([13.3 "Troubleshooting table for displayed errors"](#)).

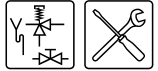

### 13.2 Troubleshooting table for general errors

**Warning**  
Maintenance may only be performed by a qualified service and maintenance engineer.

#### General errors

Symptom	Cause	Solution	Remark
<b>Gas smell</b>	Gas leak	<p>Close the main gas valve immediately.</p> <p>Do not operate any switches.</p> <p>No naked flames.</p> <p>Ventilate the boiler room.</p>	Contact your installation engineer or local gas company immediately.
<b>Display is off</b>	Appliance is turned off	Start the appliance up ( <a href="#">9 "Starting and running"</a> )	
	No supply voltage present	<ol style="list-style-type: none"> <li>1. Check if the isolator is ON.</li> <li>2. Check that there is power to the isolator.</li> <li>3. Check whether the ON/OFF switch of the electronic controller is ON (position I).</li> <li>4. Check whether there is power to the electrical connector block.</li> <li>5. The measured voltage must be 230 V<sub>AC</sub> (-15%, +10%).</li> </ol>	See the ADMR electrical diagram ( <a href="#">17 "Appendices"</a> ). If the error persists, consult your installation engineer.
	Defective fuse(s)	Replace fuse(s)	To replace the fuses, you must contact your installation engineer.
<b>Water leakage</b>	Leakage from a water connection (threaded)	Tighten the threaded connection	If the leak persists, consult your installation engineer
	Leakage from another nearby water appliance or pipe segment	Trace the leak	
	Leakage from the appliance's tank	Consult the supplier and/or manufacturer	
	Condensation	Before drawing (too much) tap water, wait until the water in the boiler has reached the set temperature.	



Symptom	Cause	Solution	Remark
<b>Explosive ignition</b> <b>Poor flame profile</b>	Incorrect supply pressure and/or burner pressure	Set the correct supply pressure and/or burner pressure. (3.11 " <u>Checking the supply pressure and burner pressure</u> ")	If ignition is not improved, consult your installation engineer.
	Contaminated burner	Clean the burner(s) (15.4.2 " <u>Clean the burner(s)</u> ")	
	Contaminated orifice	Clean the orifice(s) (15.3.4 " <u>Clean the orifice(s)</u> ")	
	Inadequate air supply	Improve the air supply by providing better ventilation in the boiler room.	
<b>Hot water supply insufficient or absent</b>	Appliance is turned off	Start the appliance up (9 " <u>Starting and running</u> ")	See the ADMR electrical diagram (17 " <u>Appendices</u> ") If the error persists, consult your installation engineer.
	No supply voltage present	<ol style="list-style-type: none"> <li>1. Check if the isolator is ON.</li> <li>2. Check that there is power to the isolator.</li> <li>3. Check whether the ON/OFF switch of the electronic controller is ON (position I).</li> <li>4. Check whether there is power to the electrical connector block.</li> <li>5. The measured voltage must be 230 VAC (-15%, +10%).</li> </ol>	
	Hot water supply is used up	Reduce hot water consumption and give the appliance time to heat up.	If there continues to be insufficient hot water, or none at all, consult your installation engineer.
	The controller is in OFF mode.	Switch the controller to the ON mode (11.2 " <u>Switching on the "ON mode"</u> ")	
Temperature ( $T_{set}$ ) is set too low.	Adjust (11.3 " <u>Setting the water temperature</u> ") temperature ( $T_{set}$ ) to a higher value.		

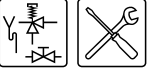

### 13.3 Troubleshooting table for displayed errors

#### **Warning**

Maintenance may only be performed by a qualified service and maintenance engineer.

#### Displayed errors

Symptom	Cause	Solution	Remark
<b>S01 (blocking error)</b>  Open circuit from temperature sensor T2 at bottom of the tank	Sensor is not (correctly) connected	Connect the sensor lead to JP3	See the ADMR electrical diagram (17 "Appendices")
	Defective flue gas sensor	Replace flue gas sensor	To replace the necessary parts, you must contact your installation engineer
	Damaged wiring	1. Measure the wire resistance of the sensor lead. This must be $\pm 0$ Ohm. 2. Replace any damaged leads	
<b>S02 (blocking error)</b>  Open circuit in sensor 1 of temperature sensor T <sub>1</sub> at the top of the tank <sup>(1)</sup> .	Sensor is not (correctly) connected	Connect the sensor lead to JP5	See the ADMR electrical diagram (17 "Appendices")
	Defective sensor	Replace sensor T <sub>1</sub>	To replace the necessary parts, you must contact your installation engineer
	Damaged wiring	1. Measure the wire resistance of the sensor lead. This must be $\pm 0$ Ohm. 2. Replace any damaged leads	
<b>S03 (blocking error)</b>  Open circuit from sensor 2 of temperature sensor T1 at the top of the tank <sup>(1)</sup>	Sensor is not (correctly) connected	Connect the sensor lead to JP5	See the ADMR electrical diagram (17 "Appendices")
	Defective sensor	Replace sensor T <sub>1</sub>	To replace the necessary parts, you must contact your installation engineer
	Damaged wiring	1. Measure the wire resistance of the sensor lead. This must be $\pm 0$ Ohm. 2. Replace any damaged leads	To replace the necessary parts, you must contact your installation engineer

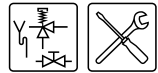

Symptom	Cause	Solution	Remark
<b>S04 (blocking error)</b>  Open circuit from flue gas sensor 1.	Flue gas sensor is not (correctly) connected.	Connect the flue gas sensor lead <sup>(2)</sup> to JP4.	See the ADMR electrical diagram (17 "Appendices")
	Defective flue gas sensor	Replace the flue gas sensor T <sub>1</sub>	To replace the necessary parts, you must contact your installation engineer
	Damaged wiring	1. Measure the wire resistance of the sensor lead. This must be ± 0 Ohm. 2. Replace any damaged leads	To replace the necessary parts, you must contact your installation engineer
<b>S05 (blocking error)</b>  Open circuit from flue gas sensor 2.	Flue gas sensor is not (correctly) connected.	Connect the flue gas sensor lead <sup>(2)</sup> to JP4.	See the ADMR electrical diagram (17 "Appendices")
	Defective flue gas sensor	Replace the flue gas sensor T <sub>2</sub>	To replace the necessary parts, you must contact your installation engineer
	Damaged wiring	1. Measure the wire resistance of the sensor lead. This must be ± 0 Ohm. 2. Replace any damaged leads	To replace the necessary parts, you must contact your installation engineer
<b>S11 (blocking error)</b>  Short circuit in the temp. sensor T2 at the bottom of the tank	Short circuit in sensor circuit	Replace sensor T <sub>2</sub> and lead	To replace the necessary parts, you must contact your installation engineer
<b>S12 (blocking error)</b>  Short circuit in sensor 1 of temperature sensor T <sub>1</sub> at the top of the tank <sup>(1)</sup>	Short circuit in sensor circuit	Replace sensor T <sub>1</sub> and lead	To replace the necessary parts, you must contact your installation engineer
<b>S13 (blocking error)</b>  Short circuit in sensor 2 of temperature sensor T1 at the top of the tank <sup>(1)</sup>	Short circuit in sensor circuit	Replace sensor T <sub>1</sub> and lead	To replace the necessary parts, you must contact your installation engineer

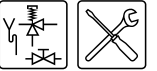

Symptom	Cause	Solution	Remark
<b>S14 (blocking error)</b> Short circuit in flue gas sensor 1	Short circuit in flue gas sensor circuit	Replace the flue gas sensor <sup>(2)</sup> and lead.	To replace the necessary parts, you must contact your installation engineer
<b>S15 (blocking error)</b> Short circuit in flue gas sensor 2	Short circuit in flue gas sensor circuit	Replace the flue gas sensor <sup>(2)</sup> and lead.	To replace the necessary parts, you must contact your installation engineer
<b>F01 (blocking error)</b> Defect in power supply circuit	Live and neutral connected wrong way round	Connect live and neutral correctly (3.10 "Electrical connection"); the appliance is phase-sensitive	See the ADMR electrical diagram (17 "Appendices")
	Condensation on the flame probe	<ol style="list-style-type: none"> <li>1. Disconnect the lead at the flame probe</li> <li>2. Ignite the appliance three times, with an interrupted ionisation circuit</li> <li>3. Reconnect the ionisation lead to the flame probe</li> <li>4. Ignite the appliance again</li> <li>5. The repeated ignition attempts will have caused the condensation to evaporate</li> </ol>	If errors persist, contact your installation engineer
	Floating neutral	Install an isolating transformer (3.10.5 "Connecting an isolating transformer")	Contact your installation engineer to have an isolating transformer installed

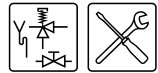

Symptom	Cause	Solution	Remark
<b>F04 (lock out error)</b>  Three unsuccessful ignition attempts.	No gas	1. Open the main gas valve and/or the manual gas valve supplying the water heater 2. Check the supply pressure to the gas control 3. If necessary, repair the gas supply	To repair the gas supply, contact your installation engineer
	Air in the gas pipes	Bleed the air out of the gas pipe	See <a href="#">Checking the supply pressure and burner pressure</a> for how to bleed air from the gas line, and measure the supply pressure and burner pressure.
	No burner pressure	1. Check the burner pressure to the gas control 2. Check that the gas valve(s) open and shut correctly 3. If necessary, replace the gas control.	
	Defect in the hot surface igniter circuit	1. Check that the hot surface igniter is correctly connected (JP2). 2. Check the wiring of the hot surface igniter. 3. Measure the resistance across the hot surface igniter. This must lie between 2 and 5 ohms. 4. Check that the hot surface igniter lights up during ignition. 5. If necessary, replace the hot surface igniter.	If the error persists, contact your installation engineer. To replace the necessary parts, you must contact your installation engineer
	Defect in the ionisation circuit	1. Check that the flame probe is correctly connected (JP2) 2. Check the wiring of the flame probe 3. Measure the ionisation current. This must be at least 1.5 microamps. 4. Replace the wiring if necessary.	
Supply voltage too low	Check the supply voltage, this must be 230 V <sub>AC</sub> (-15%, +10%).		
<b>F05 (lock out error)</b>  Too many flame errors have been signalled.	Incorrect roof flue terminal Recirculating flue gases.	1. Check that the correct roof flue terminal ( <a href="#">3.9 "Chimney flue"</a> ) has been installed. 2. If necessary, install the correct roof or wall conduit. 3. Check that the roof or wall conduit discharges into a permitted area.	If the error cannot be resolved or is persistent, contact your installation engineer

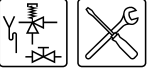

Symptom	Cause	Solution	Remark
<b>F06 (lock out error)</b>  Short circuit between flame probe and earth	Damaged cable in contact with metal surface.	Check the wiring of the flame probe. If necessary, replace the wiring.	If the error persists, contact your installation engineer. To replace the necessary parts, you must contact your installation engineer
	Ceramic part of the flame probe is broken/cracked.	1. Check that the ceramic part of the flame probe is still intact in the vicinity of the burner's air distribution plate. 2. If not, the flame probe must be replaced.	
<b>F07 (lock out error)</b>  A flame has been detected after the gas valve was closed.	Defective gas valves	1. Check whether there is still burner pressure present after the gas valves have closed. 2. Check whether a flame is still present after the gas valves have closed. 3. If this is the case, the gas control must be replaced.	If the error cannot be resolved or is persistent, contact your installation engineer To replace the necessary parts, you must contact your installation engineer
<b>F08 (lock out error)</b>  Error message from safety relay	Flame detection before the gas valve opened.	1. Reset electronic controller. 2. If the error reappears, replace the electronic controller.	If the error cannot be resolved or is persistent, contact your installation engineer To replace the necessary parts, you must contact your installation engineer
<b>F09 (lock out error)</b>  Water temperature safety.	The temperature at the top of the tank exceeds 93 °C.	1. Check that the circulation pump (if present) is working 2. Check the position of the temperature sensor T <sub>1</sub> . 3. Reset appliance controller <hr/> <b>Note</b> Error "F09" stays active if the water temperature was higher than 78 °C during the reset. If this is the case, first open the nearest draw-off point to drain some hot water and allow cold water to run into the system.	If the error cannot be resolved or is persistent, contact your installation engineer
<b>F10 (lock out error)</b>  Restriction on the number of ignition attempts based on switching of the flue damper relay.	Flue damper relay switching during demand.	1. Check that the red arrow on the flue damper motor goes fully to the right and stays in this position during heat demand. 2. Check for physical blockages, and rectify if possible. 3. Check that the voltage on the black lead of the motor controller continues during heat demand. 4. Check for faulty electrical connections and rectify if possible.	If the error cannot be resolved or is persistent, contact your installation engineer To replace the necessary parts, you must contact your installation engineer



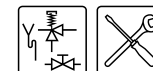

Symptom	Cause	Solution	Remark
<b>F11 (blocking error)</b>  Flame detection with closed gas valve.	Defective gas valves	See F07.	
<b>F12 (lock out error)</b>  The flue gas backflow safeguard is activated.	Chimney flue blocked	1. Check for blockages in the chimney flue pipe 2. Remove any blockages 3. Reset electronic controller.	If the error cannot be resolved or is persistent, contact your installation engineer
<b>F13 (lock out error)</b>  Flue damper not driven by the motor	The motor fails to open the flue damper	See <b>F10</b>	If the error cannot be resolved or is persistent, contact your installation engineer
<b>F14 (lock out error)</b>  The microswitch fails to monitor the position of the flue damper	The microswitch fails to detect the position of the flue damper	1. Check that the red arrow on the motor goes fully to the right and/or left 2. Check that the microswitch is activated when the damper rotates	If the error cannot be resolved or is persistent, contact your installation engineer

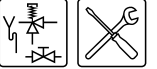

Symptom	Cause	Solution	Remark
<b>C02 (lock out error)</b> Error message from the appliance controller.	Incorrect reference voltage from the AD converter.	<ol style="list-style-type: none"> <li>1. Reset electronic controller.</li> <li>2. Check that the frequency of the power supply is compliant (3.4.2 "General and electrical specifications"). If this is not the case, contact your installation engineer</li> <li>3. If the frequency is correct but the error persists, replace the electronic controller.</li> </ol>	To replace the necessary parts, you must contact your installation engineer
Internal error message from the appliance controller.	<ul style="list-style-type: none"> <li>• EEPROM read error</li> <li>• 50 Hz error</li> <li>• Internal communication error</li> </ul>		
Internal error message from the appliance controller.	<ul style="list-style-type: none"> <li>• Gas valve relay error</li> <li>• Safety relay error</li> <li>• Ignition relay error</li> <li>• RAM error</li> <li>• EEPROM error</li> <li>• EEPROM contents do not match the software version</li> </ul>		
<b>C03 (blocking error)</b> Reset error	Too many resets in too short a period.	Wait for the error to disappear (maximum 1 hour). If the error does not disappear, replace the appliance controller.	To replace the necessary parts, you must contact your installation engineer
<b>C04 (blocking error)</b> Appliance selection error	Incorrect appliance selection / Incorrect selection resistor.	<ol style="list-style-type: none"> <li>1. Check whether the correct appliance is selected (12.5 "Display the selected appliance").</li> <li>2. If the correct appliance is selected, fit the correct selection resistor.</li> <li>3. If incorrect appliance selected, select the correct one.</li> </ol>	<p>If the error cannot be resolved or is persistent, contact your installation engineer</p> <p>To replace the necessary parts, you must contact your installation engineer</p>

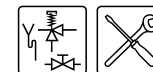

Symptom	Cause	Solution	Remark
<b>E01 (blocking error)</b>  The temperature protection at the top of the tank has been activated.	The temperature of the water at the top of the tank is $> 85\text{ }^{\circ}\text{C}$ .	None. This is a temporary message that may appear from time to time, but will disappear automatically.	
<b>E03 (lock-out error)</b>  Error in temperature sensor $T_1$ at the top of the tank.	The two temperature sensors in the tank detect a differential of $\geq 10\text{ }^{\circ}\text{C}$ over a period of at least 60 seconds.	<ol style="list-style-type: none"> <li>1. Check sensor position and wiring.</li> <li>2. If necessary, reset the electronic controller. Replace the sensor if the error persists.</li> </ol>	To replace the necessary parts, you must contact your installation engineer
<b>E04 (lock-out error)</b>  Error in dummy sensor <sup>(2)</sup> .	The two dummy sensors in the tank detect a differential of $\geq 10\text{ }^{\circ}\text{C}$ over a period of at least 60 seconds.	<ol style="list-style-type: none"> <li>1. Check leads from dummy 1 and dummy 2.</li> <li>2. If necessary, reset the electronic controller. Replace the dummy sensor if the error persists.</li> </ol>	To replace the necessary parts, you must contact your installation engineer
(1) Temperature sensor $T_1$ is a '2 in 1' sensor: $T_1$ , contains 2 NTCs for maximum thermostat and safety thermostat protection. (2) The flue gas sensor comprises flue gas sensor 1 and flue gas sensor 2.			

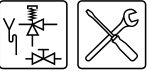

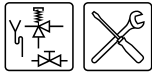

# 14 Maintenance frequency

## 14.1 Introduction

A service should be carried out at least once a year, both on the water side and on the gas side. Maintenance frequency depends, among other things, on the water quality, the average burning time per day and the set water temperature.

---

### Note

Regular maintenance extends the service life of the appliance.

To determine the correct maintenance frequency, it is recommended to arrange for the service and maintenance engineer to check the appliance on both the water and gas side, three months after installation. Based on this check, the best maintenance frequency can be determined.

---

## 14.2 Determining service interval

To aid servicing, the electronic controller has a service interval with which the service and maintenance engineer can determine the frequency of maintenance, based on the number of burning hours.

The service interval can be set to: 500, 1000 or 1500 burning hours. The standard setting is 500 burning hours.

---

### Example

*In the first three months, the appliance has burnt 300 hours. During maintenance, it is evident that one service per year will be sufficient. Therefore, after one year, some 1200 burning hours will have elapsed. The first value below 1200 hours that can be selected is 1000 burning hours.*

*In this case, the service and maintenance engineer sets the interval to 1000.*

*In the first three months, the appliance has burned for 300 hours. During maintenance, it is evident (perhaps due to the water quality) that service will be required at least once every 6 months.*

*Therefore, after six months, some 600 burning hours will have elapsed. The first value below 600 hours that can be selected is 500 burning hours.*

*In this case, the service and maintenance engineer sets the interval to 500.*

---

```
!!! WARNING !!!  
  
MAX. BURNINGHOURS:  
SERVICE REQUIRED
```

Once the set number of burning hours has elapsed, the message `SERVICE REQUIRED` will appear on the display. When this message appears, the service and maintenance engineer must be contacted.

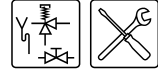



# 15 Performing maintenance

## 15.1 Introduction

### **Caution**

Maintenance may only be performed by a qualified service and maintenance engineer.

At each service, the appliance undergoes maintenance on both the water side and the gas side. The maintenance must be carried out in the following order.



1. Preparation for maintenance;
2. Water-side maintenance;
3. Gas-side maintenance;
4. Finalizing maintenance.

### **Note**

To order spare parts, it is important to write down the appliance type and model, and the full serial number of the appliance. These details can be found on the rating plate. Only by ordering with this information can you be sure to receive the correct spare parts.

## 15.2 Preparation for maintenance

To test whether all components are still working properly, complete the following steps:

1. Activate the MENU with .
2. Use:  and  to place the cursor beside OFF.
3. Confirm OFF with ENTER.



```
MENU
→OFF
^ ON
v WEEK PROGRAM
```

4. Switch the appliance **OFF (position 0)** using the ON/OFF switch on the control panel.
5. Switch the electronic controller **ON** by setting the ON/OFF switch to **position I**.

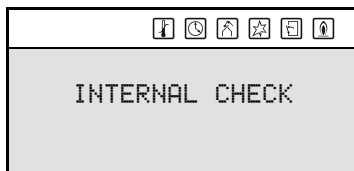

```
INTERNAL CHECK
```

The display will now show **INTERNAL CHECK** for about 10 seconds, and will then go to the main menu.



6. Activate "ON mode" by going through the following steps:
- Press once on the blue arrow (↓) to position the cursor beside ON, then press ENTER.

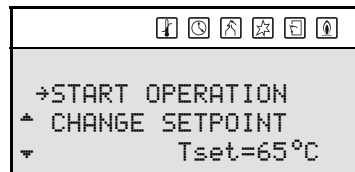

- Confirm the selection START OPERATION with ENTER.
7. If there is no heat demand, increase Tset (11.3 "Setting the water temperature"). Note the original setting. Draw some hot water off to create heat demand.
  8. Check whether the heating cycle is running correctly (9.2 "The appliance's heating cycle").
  9. If you have adjusted T<sub>set</sub>, return it to the original value (11.3 "Setting the water temperature").
  10. Check the supply and burner pressure (3.11 "Checking the supply pressure and burner pressure"), and adjust them if necessary.
  11. Check that all components of the chimney flue system are properly attached.
  12. Test the operation of the overflow valve of the protected cold supply setup. The water should spurt out.
  13. Test the overflow operation of the T&P valve. The water should spurt out.
  14. Check the drainpipes from the discharge points of all valves and remove any scale deposits that may be present.
  15. Drain the appliance (6 "Draining").

### 15.3 Water-side maintenance

#### 15.3.1 Introduction

The following steps must be carried out on the water side:

1. Checking the anodes.
2. Descaling and cleaning the tank.

#### 15.3.2 Checking the anodes

Timely replacement of the anodes extends the service life of the appliance. The appliance's anodes must be replaced as soon as they are 60% or more used up (take this into consideration when determining the maintenance frequency).



#### Warning

The draught diverter and cover can be hot.

1. Detach the wiring from the flue damper.
2. Withdraw the sensor cable plug from the flue gas sensor.
3. Detach the fastening brackets from the flue gas sensor.





4. Disconnect the draught diverter from the flue gas discharge.
5. Undo the screws on the draught diverter.
6. Remove the draught diverter from the appliance.
7. Undo the screws of the lid in the top side of the appliance.
8. Remove the lid from the appliance.
9. Remove the sealing ring from the appliance.
10. Now also check the flue baffles ([15.4.3 "Checking the flue baffles"](#)). If necessary, replace them.
11. Place a new sealing ring on the rim of the tank and re-fit the lid.
12. Fit the draught diverter ([3.9.2 "Fitting the draught diverter"](#)).
13. Fit the flue damper ([3.9.3 "Fitting the flue damper"](#)).
14. Fit the flue gas sensor ([3.9.4 "Fitting the flue gas sensor"](#)).
15. Re-fit the protective cover.

### 15.3.3 Descaling and cleaning the tank

Scale and lime buildup prevent effective conduction of the heat to the water. Periodic cleaning and descaling prevents buildup of these deposits. This increases the service life of the appliance, and also improves the heating process.

Take the rate of scale formation into account when deciding on maintenance frequency. Scale formation depends on the local water composition, the water consumption and the water temperature setting. A water temperature setting of maximum 60 °C is recommended for prevention of excessive scale buildup.

To ensure the perfectly watertight sealing of a cleaning opening, the gasket (6), O-ring (7), sealing rings (4), bolts (3) and possibly the lid (5) should be replaced with new components after opening (see the figure). A special set is obtainable from the supplier/manufacturer.

To simplify the task of descaling and cleaning the tank, the appliance is equipped with two cleaning openings.

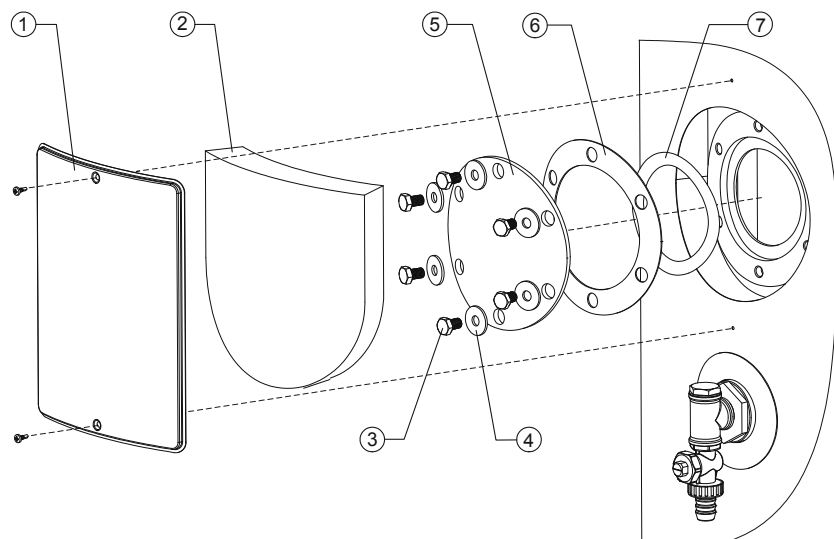

IMD-0235 R2

1. Remove the cover plate (1) on the outer jacket (see the figure).
2. Carefully remove the insulation layer (2) and set it to one side. This will be needed again later.



3. Undo the bolts.
4. Remove the lid, the gasket and the O-ring.
5. Inspect the tank and remove the loose scale deposits and contamination.
6. If the scale cannot be removed by hand, descale the appliance with a descaling agent. Contact the supplier/manufacturer for advice on what descaling agent to use.

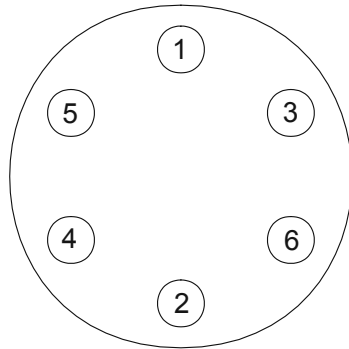

IMD-0282 R1

7. Close the cleaning opening. To avoid damage to the tank, tighten the bolts that fasten the lid with a torque no greater than 50 Nm. Use suitable tools for this. For the best possible watertight seal of the cleaning opening, the bolts in the lid should be torqued down in the sequence shown in the figure.

#### 15.3.4 Clean the orifice(s)

1. Detach the orifice(s)
2. Remove all contamination present in the orifice(s).
3. Fit the orifice(s)

### 15.4 Gas-side maintenance

#### 15.4.1 Introduction

The following steps must be carried out on the gas side:

1. Clean the burner(s).
2. Clean the orifice(s).
3. Checking the flue baffles.

#### 15.4.2 Clean the burner(s)

1. Detach the burner(s)
2. Remove all contamination present on the burner(s).
3. Fit the burner(s)

#### 15.4.3 Checking the flue baffles



#### Warning

The draught diverter and cover can be hot.

1. Detach the wiring from the flue damper.
2. Withdraw the sensor cable plug from the flue gas sensor.
3. Detach the fastening brackets from the flue gas sensor.
4. Disconnect the draught diverter from the flue gas discharge.



5. Undo the screws on the draught diverter.
6. Remove the draught diverter from the appliance.
7. Undo the screws of the lid in the top side of the appliance.
8. Remove the lid from the appliance.
9. Remove the sealing ring from the appliance.

---

 **Warning**

The flue baffles can be hot.

---

1. Remove the flue baffles from the appliance.
2. Check the flue baffles for the presence of corrosion, removing this if necessary.
3. Check the flue baffles for wear, and replace the flue baffles if necessary.
4. Place a new sealing ring on the rim of the tank and re-fit the lid.
5. Fit the draught diverter ([3.9.2 "Fitting the draught diverter"](#)).
6. Fit the flue damper ([3.9.3 "Fitting the flue damper"](#)).
7. Fit the flue gas sensor ([3.9.4 "Fitting the flue gas sensor"](#)).
8. Re-fit the protective cover.

## 15.5 Finalizing maintenance

To finalize the maintenance carry out the following steps:

1. Fill the appliance ([5 "Filling"](#)).
2. Start the appliance ([9 "Starting and running"](#)).
3. Erase the message **SERVICE REQUIRED**. Do this by pressing once on **RESET** then once on **ENTER**.



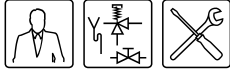

# 16 Warranty (certificate)

To register your warranty, you should complete and return the enclosed warranty card after which a warranty certificate will be sent to you. This certificate gives the owner of a appliance supplied by A.O. Smith Water Products Company B.V. of Veldhoven, The Netherlands (hereinafter "A.O. Smith") the right to the warranty set out below, defining the commitments of A.O. Smith to the owner.

## 16.1 General warranty

If within one year of the original installation date of a water heater supplied by A.O. Smith, following verification, and at the sole discretion of A.O. Smith, a section or part (with exclusion of the tank) proves to be defective or fails to function correctly due to manufacturing and/or material defects, then A.O. Smith shall repair or replace this section or part.

## 16.2 Tank warranty

If within 3 years of the original installation date of a water heater supplied by A.O. Smith, following inspection, and at the sole discretion of A.O. Smith, the glass-lined steel tank proves to be leaking due to rust or corrosion occurring on the water side, then A.O. Smith shall offer to replace the defective water heater with an entirely new water heater of equivalent size and quality. The warranty period given on the replacement water heater shall be equal to the remaining warranty period of the original water heater that was supplied. Notwithstanding that stated earlier in this article, in the event that unfiltered or softened water is used, or allowed to stand in the water heater, the warranty shall be reduced to one year from the original installation date.

## 16.3 Conditions for Installation and use

The warranty set out in article 1 and 2 will apply solely under the following conditions:

- a. The water heater is installed under strict adherence to A.O. Smith installation instructions for the specific model, and the relevant government and local authority installation and building codes, rules and regulations in force at the time of installation.
- b. The water heater remains installed at the original site of installation.
- c. The appliance is exclusively used with drinking water, which at all times can freely circulate (a separately installed heat exchanger is mandatory for heating salt water or corrosive water).
- d. The tank is safeguarded against harmful scaling and lime buildup by means of periodic maintenance.
- e. The water temperatures in the heater do not exceed the maximum setting of the thermostats, which form a part of the water heater.
- f. The water pressure and/or heat load do not exceed the maximum values stated on the water heater rating plate.
- g. The water heater is installed in a non-corrosive atmosphere or environment.
- h. The water heater is connected to a protected cold supply arrangement, which is: approved by the relevant authority; with sufficient capacity for this purpose; supplying a pressure no greater than the working pressure stated on the water heater; and where applicable by a likewise approved temperature and pressure relief valve, fitted in accordance with installation instructions of A.O. Smith applying to the specific model of water heater, and further in compliance with the government and local authority installation and building codes, rules and regulations.
- i. The appliance is at all times fitted with cathodic protection. If sacrificial anodes are used for this, these must be replaced and renewed when, and as soon as, they are 60% or more consumed. When electric anodes are used, it is important to ensure that they continue to work properly.

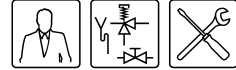

#### 16.4 Exclusions

The warranty set out in articles 1 and 2 will not apply in the event of:

- a. damage to the water heater caused by an external factor;
- b. misuse, neglect (including frost damage), modification, incorrect and/or unauthorised use of the water heater and any attempt to repair leaks;
- c. contaminants or other substances having been allowed to enter the tank;
- d. the conductivity of the water being less than 125  $\mu\text{S}/\text{cm}$  and/or the hardness (alkaline-earth ions) of the water being less than 1.00 mmol/litre (3.3.3 "Water composition");
- e. unfiltered, recirculated water flowing through or being stored in the water heater;
- f. any attempts at repair to a defective water heater other than by an approved service engineer.

#### 16.5 Scope of the warranty

The obligations of A.O. Smith pursuant to the specified warranty do not extend beyond free delivery from the Veldhoven warehouse of the replacement sections, parts or water heater respectively. Shipping, labour, installation and any other costs associated with the replacement will not be accepted by A.O. Smith.

#### 16.6 Claims

A claim on grounds of the specified warranty must be submitted to the dealer from whom the water heater was purchased, or to another authorised dealer for A.O. Smith Water Products Company products. Inspection of the water heater as referred to in articles 1 and 2 shall take place in one of the laboratories of A.O. Smith Water Products Company.

#### 16.7 Obligations of A.O. Smith

A.O. Smith grants no other warranty or guarantee over its water heaters nor the (sections or parts of) water heaters supplied for replacement, other than the warranty expressly set out in this Certificate.

Under the terms of the supplied warranty, A.O. Smith is not liable for damage to persons or property caused by (sections or parts, or the glass-lined steel tank of) a (replacement) water heater that it has supplied.



# 17 Appendices

## 17.1 Introduction

This appendix contains:

- Electrical diagrams ADMR ([17.2 "Electrical Diagrams ADMR"](#));
- [Week program card](#).

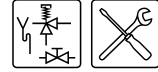

### 17.2 Electrical Diagrams ADMR

#### 17.2.1 Electrical Diagram ADMR 40 through 115 and 135 natural gas, ADMR 40 through 115 LP gas

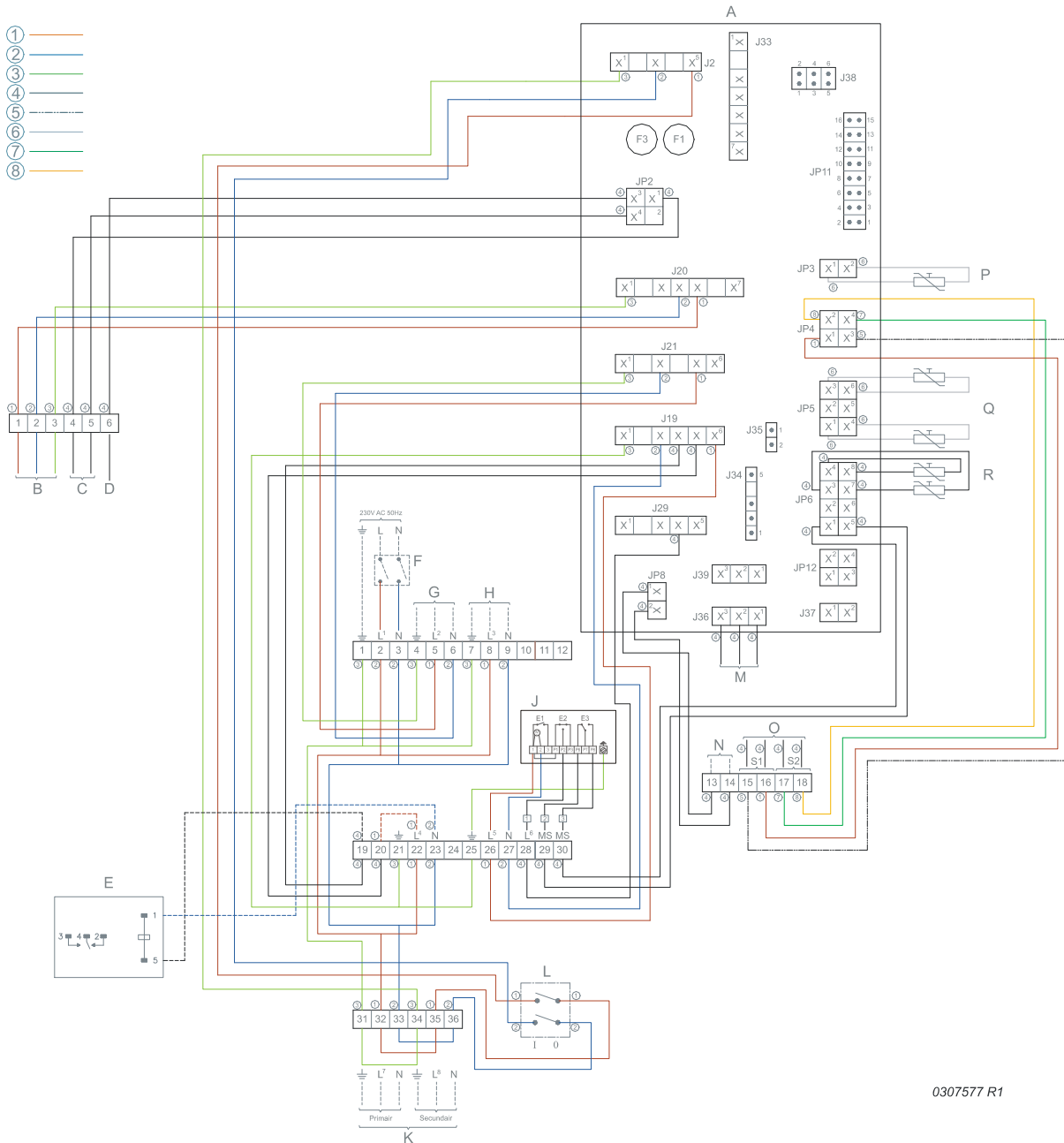

0307577 R1

1 = brown, 2 = blue, 3 = yellow/green, 4 = black, 5 = white, 6 = grey/beige, 7 = green, 8 = yellow





#### TERMINAL STRIP CONNECTIONS:

⏏	Earth
N	Neutral
L <sub>1</sub>	Live input of Controller
L <sub>2</sub>	Live input of program-controlled pump
L <sub>3</sub>	Live input of continuous pump
L <sub>4</sub>	Live input of extra error signal connection
L <sub>5</sub>	Live input of flue damper motor
L <sub>6</sub>	Live output of flue damper motor (feedback)
L <sub>7</sub>	Live input of isolating transformer (primary side)
L <sub>8</sub>	Live output of isolating transformer (secondary side)

#### COMPONENTS:

A	Controller
B	Gas control
C	Hot surface igniter
D	Flame probe
E	Extra error signal connection
F	Double-pole isolator
G	Program-controlled pump
H	Continuous pump
J	Flue damper
K	Isolating transformer
L	Controller O/I switch
M	Display
N	Extra ON mode switch
O	Connection for flue gas sensor
P	Temperature sensor (T2 - bottom of tank)
Q	Temperature sensor (T1 - top of tank)
R	Selection resistor

#### CONTROLLER CONNECTIONS:

J2	Power connection for controller
J19	Extra error signal connection and power to flue damper
J20	Gas control connection
J21	Program-controlled pump connection
J29	Connection for the feedback from the flue damper
J36	Controller display connection
JP2	Flame probe and hot surface igniter connection
JP3	Temperature sensor T2 connection
JP4	Flue gas sensor connection
JP5	Temperature sensor T1 connection
JP6	Connection for selection resistor, and feedback from microswitch
JP8	Extra ON mode switch connection
F1	Fuse
F3	Fuse

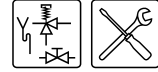

### 17.2.2 Electrical Diagram ADMR 135 LP gas

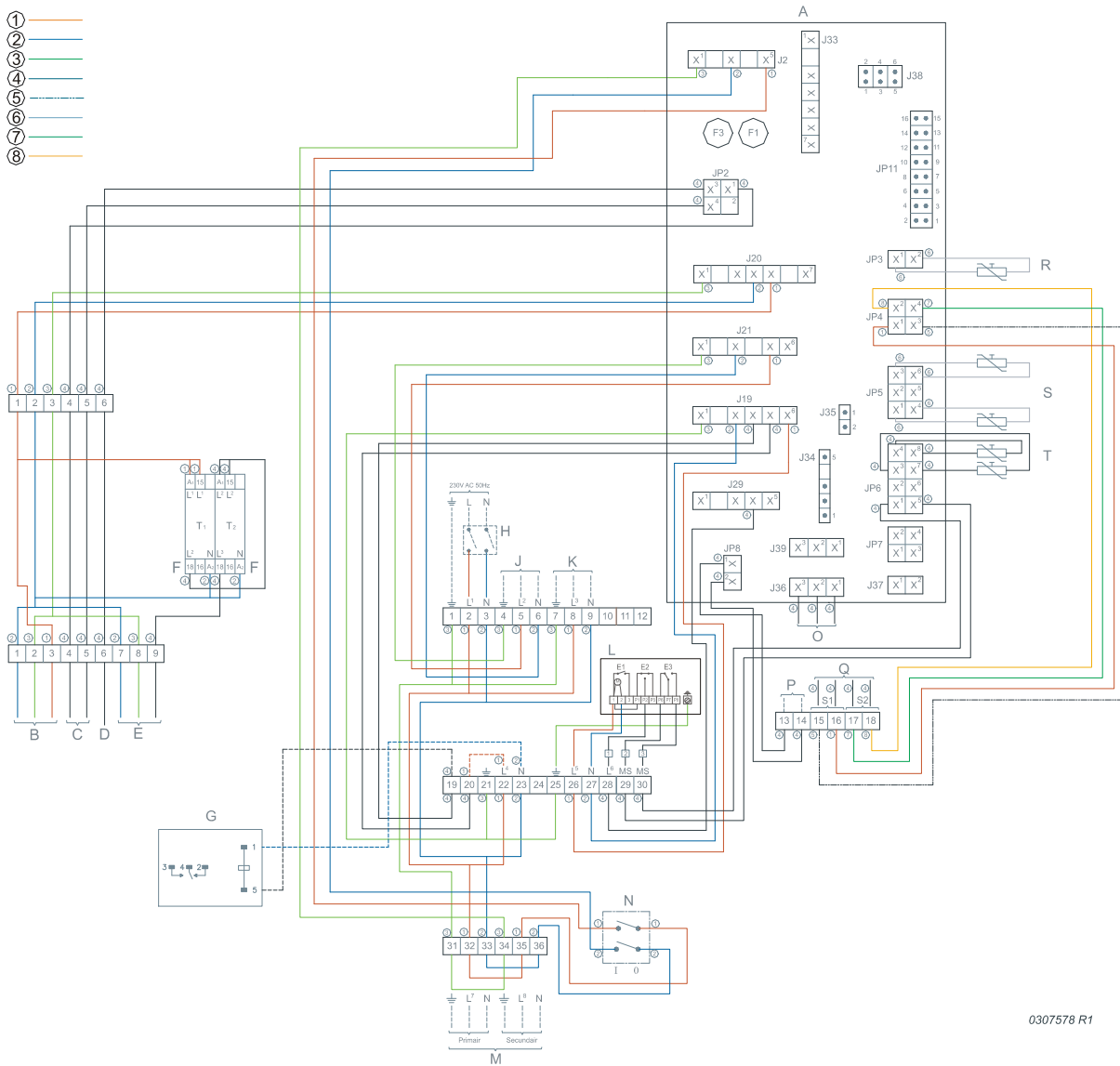

0307578 R1

1 = brown, 2 = blue, 3 = yellow/green, 4 = black, 5 = white, 6 = grey/beige, 7 = green, 8 = yellow



#### TERMINAL STRIP CONNECTIONS:

⊥	Earth
N	Neutral
L <sub>1</sub>	Live input of Controller
L <sub>2</sub>	Live input of program-controlled pump
L <sub>3</sub>	Live input of continuous pump
L <sub>4</sub>	Live input of extra error signal connection
L <sub>5</sub>	Live input of flue damper motor
L <sub>6</sub>	Live output of flue damper motor (feedback)
L <sub>7</sub>	Live input of isolating transformer (primary side)
L <sub>8</sub>	Live output of isolating transformer (secondary side)

#### COMPONENTS:

A	Controller
B	Gas control
C	Hot surface igniter
D	Flame probe
E	High-low control
F	Timer
G	Extra error signal connection
H	Double-pole isolator
J	Program-controlled pump
K	Continuous pump
L	Flue damper
M	Isolating transformer
N	Controller I/O switch
O	Display
P	Extra ON mode switch
Q	Connection for flue gas sensor
R	Temperature sensor (T2 - bottom of tank)
S	Temperature sensor (T1 - top of tank)
T	Selection resistor

#### CONTROLLER CONNECTIONS:

J2	Power connection for controller
J19	Extra error signal connection and power to flue damper
J20	Gas control connection
J21	Program-controlled pump connection
J29	Connection for the feedback from the flue damper
J36	Controller display connection
JP2	Flame probe and hot surface igniter connection
JP3	Temperature sensor T2 connection
JP4	Flue gas sensor connection
JP5	Temperature sensor T1 connection
JP6	Connection for selection resistor, and feedback from microswitch
JP8	Extra ON mode switch connection
F1	Fuse
F3	Fuse

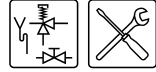

### 17.3 Week program card

You can cut the week program card out and keep it near the appliance.

Period		DAY	TIME	Tset	Pump
1.	ON			.... °C	ON / OFF
	OFF				
2.	ON			.... °C	ON / OFF
	OFF				
3.	ON			.... °C	ON / OFF
	OFF				
4.	ON			.... °C	ON / OFF
	OFF				
5.	ON			.... °C	ON / OFF
	OFF				
6.	ON			.... °C	ON / OFF
	OFF				
7.	ON			.... °C	ON / OFF
	OFF				
8.	ON			.... °C	ON / OFF
	OFF				
9.	ON			.... °C	ON / OFF
	OFF				
10.	ON			.... °C	ON / OFF
	OFF				
11.	ON			.... °C	ON / OFF
	OFF				

Period		DAY	TIME	Tset	Pump
12.	ON			.... °C	ON / OFF
	OFF				
13.	ON			.... °C	ON / OFF
	OFF				
14.	ON			.... °C	ON / OFF
	OFF				
15.	ON			.... °C	ON / OFF
	OFF				
16.	ON			.... °C	ON / OFF
	OFF				
17.	ON			.... °C	ON / OFF
	OFF				
18.	ON			.... °C	ON / OFF
	OFF				
19.	ON			.... °C	ON / OFF
	OFF				
20.	ON			.... °C	ON / OFF
	OFF				
21.	ON			.... °C	ON / OFF
	OFF				

#### Example

Period		DAY	TIME	Tset	Pump
1.	ON	MO	14:30	70 °C	ON / OFF
	OFF	MO	16:15		





# Index

## A

- ambient temperature 16
- appliance
  - displaying history 64
  - displaying selection 64
  - heating cycle 12

## B

- burner pressure 33

## C

- claims 86
- connect
  - circulation piping 24, 25
  - cold water side 23, 24
  - electrical 29, 31
  - gas 25
  - hot water side 24
  - shut pipe 23, 24
- connecting circulation pipe 24, 25
- connecting cold water side 23, 24
- connecting hot water side 24
- controls 55
- conversion to a different gas category 37

## D

- displaying error history 63
- disposal 53
- document contents 9
- draining 45

## E

- electrical connection 29
- electrical connector block 30
- environmental conditions 15
- error 50
- extra period 49
  - operating mode 49
  - settings 59

## F

- filling 43
- flame probe 13
- forms of notation 8
- frost protection 49

## G

- gas category, conversion to different 37
- gas connection 25
- general specifications 3

## H

- heating cycle 12
- humidity 16
- hysteresis setting 63

## I

- installation engineer 8
- isolator 31

## L

- language setting 60
- liability 3

## M

- mains power 31
- maintenance
  - burner 82
  - finalising 83
  - gas-side 82
  - orifice 82
  - perform 79
  - water-side 80
- mode
  - ERROR 50
  - EXTRA 49
  - OFF 49
  - ON 49
  - PROG 50
  - SERVICE REQUIRED 50

## N

- navigation buttons 48

## O

- off 49
- on 49
- ON mode 55
- on/off switch 47
- operating modes
  - EXTRA 49
  - general 49
  - OFF 49
  - ON 49
  - PROG 50

## P

- packaging 15
- PC connection 48
- prog 50
- protection 12
- pump 64

**S**

- scale 81
- scrolling 48
- service check 8, 77
- service engineer 8
- service required 50
- setting backlight time 64
- setting date 61
- setting display contrast 64
- setting display scroll speed 64
- setting service interval 64
- shunt pump 23, 24
- specifications 18
- starting up 51
- supply pressure 33
- symbol
  - installation engineer 8
  - service engineer 8
  - user 8

**T**

- target groups 8
- temperature sensor
  - T1 12
  - T2 12
- ThermoControl
  - ON/OFF switch 47
- Tnet 12
- to shut down
  - electrically isolating 53
  - longer period 53
  - short period 53
- trademarks 3

**U**

- user 8

**W**

- warranty 85
  - exclusions 86
  - general 85
  - installation and conditions of use 85
  - scope 86
- water
  - composition 16
  - setting the temperature 55
- week program 49