

Upsilon

Commercial Modular High
Efficiency Condensing Boiler

UB - 70/110/140

0310 351



Installation and Service
Manual

Version:
from sv 4.1
05-2013

Content

1	Introduction.....	4
2	Regulations	7
3	Scope of delivery.....	9
4	Description	10
5	Installation and mounting	11
5.1	Wall-mounted in line.....	12
5.2	Free-standing in line.....	13
5.3	Free-standing back to back.....	14
5.4	Connecting the boiler	15
6	Hydraulic and gas line system.....	16
6.1	Heating system	16
6.2	Expansion vessel	17
6.3	Water quality	17
6.4	Gas line	19
6.5	Condensate drain.....	20
7	Flue gas system	22
7.1	Parallel boiler connection	23
7.2	Concentric boiler connection.....	23
7.3	Connecting the flue gas outlet/air supply system.....	24
7.4	Individual flue gas outlet.....	24
7.5	Collective flue gas outlet	27
7.6	Condensate vent collective flue gas system	30
8	Electrical connections.....	31
8.1	External controls	33
8.2	Wiring diagram	34
9	Boiler control	36
9.1	Operational status	37
9.2	Operation	37
9.3	Commissioning.....	38
9.4	Setting the flow temperature with On-Off-control	40
9.5	Filling heating system.....	41
10	Basic settings	42
11	Parameters.....	44
11.1	Activate factory settings	48
12	Put out of operation	48
13	Inspection and maintenance	49
13.1	Maintenance intervals	49
13.2	Checks prior to commissioning	49
13.2.1	Pollution check.....	50
13.2.2	Control O ₂	51
13.3	Maintenance activities.....	52
13.4	Counter running hours	52
14	Error report	55
15	Warranty conditions.....	56
15.1	General warranty.....	56
15.2	Heat exchanger warranty	56
15.3	Conditions for installation and use	56
15.4	Exclusions	57
15.5	Scope of the warranty	57
15.6	Claims	57
15.7	Obligations of A.O. Smith Water Heaters.....	57
	Annex A Technical specifications.....	58
	Annex B System water additives.....	59
	Annex C Dimensions	60
	Annex D Declaration of conformity.....	65

1 Introduction

These instructions describe the functioning, installation, use and primary maintenance of A.O.Smith central heating boilers for the United Kingdom and Ireland. Where necessary the different regulations for each country are separately described.

These instructions are intended for the use of Gas Safe registered installers or registered Bord Gais installers in connection with the installation and putting into operation of A.O.Smith boilers. It is advisable to read these instructions thoroughly, well in advance of installation. Separate instructions for use are supplied with the boiler for users of A.O.Smith central heating boilers. A.O.Smith is not liable for the consequences of mistakes or shortcomings which have found their way into the installation instructions or user's manual. Further, A.O.Smith reserves the right to alter its products without prior notification.



When delivering the boiler, give the customer clear instructions concerning its use; present the customer with the user's manual.



With regard to installing flue systems and/or external controls, we refer you to the supplier involved.

Each boiler is fitted with an identification plate. Consult the details on this plate to verify whether the boiler is compliant with its intended location, e.g.: gas type, power source and exhaust classification.



figure 1.a

description components

- | | | | |
|----|--|-----|---|
| 1 | heat exchanger 1 (All UB-types) | 16 | service valves flow/return (in optional boiler connections set) |
| 2 | heat exchanger 2 (UB 110 and UB 140) | 17 | fill and drain valve (in optional boiler connections set) |
| 3 | ignition unit | 18 | safety valve (in optional boiler connections set) |
| 4 | fan unit | 19 | flue connection |
| 5 | damper | 20 | air supply |
| 6 | gas valve | 21 | collective flue pipe |
| 7 | automatic air vent | 22 | information plate |
| 8 | main switch 230V | T1 | flow sensor |
| 9 | boiler control unit | T1a | secondary flow sensor (only HEX4) |
| 10 | control unit MMI | T2 | return sensor |
| 11 | connection terminal | P1 | water pressure sensor |
| 12 | connection terminal cascade bus communication | G | gas pipe |
| 13 | syphon | A | flow pipe CH |
| 14 | circulation pump | R | return pipe CH |
| 15 | gas isolation valve (in optional boiler connections set) | C | condensate drain pipe |

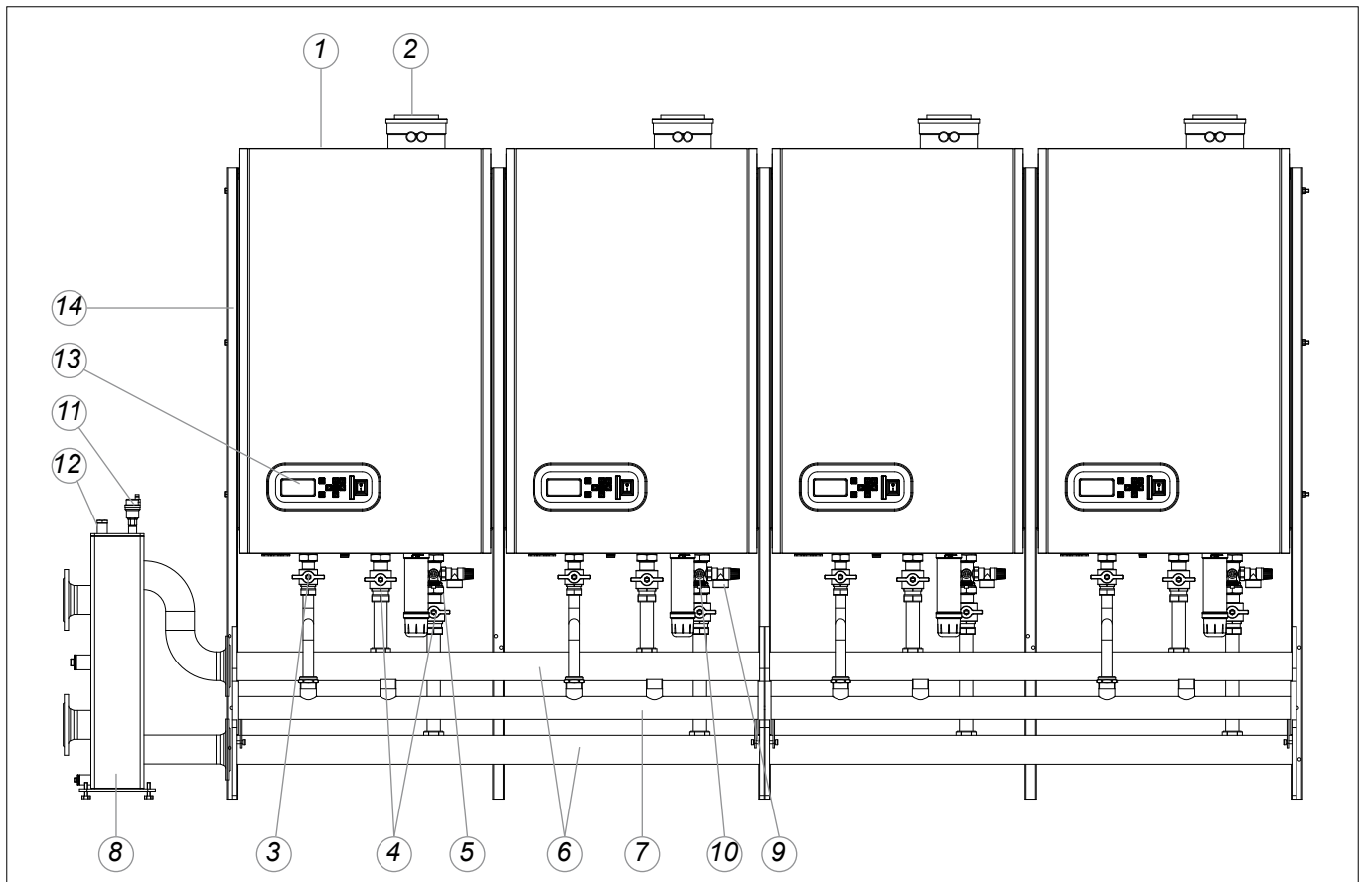

description components

figure 1.b

- | | | | |
|---|---|----|--|
| 1 | Air supply (for parallel flue connection) | 8 | Low velocity header |
| 2 | Flue/Air supply (concentric) | 9 | Safety valve |
| 3 | Gas isolation valve | 10 | Fill and drain valve |
| 4 | Service valves flow and return | 11 | Automatic air vent low velocity header |
| 5 | Non-return valve | 12 | Pocket for temperature sensor T10 |
| 6 | Flow/return header | 13 | Cascade manager |
| 7 | Gas line | 14 | Frame |

2 Regulations

The following regulations apply to the installation of A.O.Smith central heating boilers:

Legislation and Regulations.

Gas Safety (Installation and Use) Regulations. All gas appliances must by law, be installed by a competent person, eg. Members of Gas Safe Register and in accordance with the current Gas Safety (Installation and Use) Regulations. Failure to install the appliance correctly could lead to prosecution.

All Gas Safe registered installers carry a Gas Safe ID card and have a registration number. You can call Gas Safe Register directly on 0800 408 5577.

In addition to the above regulations this appliance must be installed in compliance with the current IEE Regulations, the Building Standards (Scotland Consolidation) Regulations. Regulations and byelaws of the Local Water Authority and the Current Health and Safety Regulation.

Ireland:

- Irish standard 813

The current Electricity at Work Regulation must be complied with and also be in accordance with the relevant and current editions of the British Standards.

The Upsilon boiler is a certified appliance and must not be modified or installed in any way contrary to this Installation Manual. Manufacturers instructions must not be taken, in any way, as overriding statutory obligations.

The Upsilon is a central heating boiler for individual or multiple cascade purposes. These boilers must be connected according to these instructions and all installation norms in respect of the part of the boiler to be connected.



The appliance is not to be used by children or persons with reduced physical, sensory or mental capabilities, or lack of experience and knowledge, unless they have been given supervision or instructions.



Children being supervised are not to play with the appliance.

Observe the following rules of safety:

- All work on the boiler must take place in a dry environment.
- Upsilon boilers may never be in operation without their housing, except in connection with maintenance or adjustments (see Chapter 13).
- Never allow electrical or electronic components to come into contact with water.

Carry out the following tasks in connection with maintenance, etc. to an already-installed boiler:

- Shut down all programs
- Close the gas isolation valve
- Turn off the boilers electrical isolator switch.

Take note of the following when maintenance or adjustments are needed:

- The boiler must be able to function during these activities; for this reason, the boiler's supply voltage, gas pressure and water pressure must be maintained. Ensure that there is not a source of potential danger during these activities.



Following maintenance or other activities; always check the connections of all parts through which gas flows (using leak-search spray).

The following (safety) symbols may be encountered in these installation instructions and on the boiler:



This symbol indicates that the boiler must be stored away from frost.



This symbol indicates that the packaging and/or contents can be damaged as a result of insufficient care taken during transport.



This symbol indicates that, whilst still in its packaging, the boiler must be protected from weather conditions during transport and storage.



KEY-symbol. This symbol indicates that assembly or dismantling, must be carried out.



ATTENTION symbol. This symbol indicates that extra attention must be paid in connection with a particular operation.



Useful tip or advice.

3 Scope of delivery

The boiler will be delivered ready for use. The delivery package includes the following:

- Boiler and housing:
 - Boiler pump(s);
 - Cascade control system;
 - Automatic air vent(s);
- Siphon;
- Lid \varnothing 100 air supply (with screw);
- PG cable glands;
- Suspension bracket;
- Mounting material consisting of plugs and screws;
- Installation and Service Manual;
- User manual;

Depending on the selected cascade systems, the following parts are supplied:

1. Pipe work headers for flow/return and gas
 - DN65 or DN100 flow/return pipe work headers for 2 or 3 boilers with:
 - Flanges, M12/16 bolts, nuts, spring washers and gaskets
 - 35 mm blind covers for unused boiler connections
 - DN50 or DN65 gas pipe work headers for 2 or 3 boilers with:
 - Flanges, M12 bolts, nuts, spring washers and gaskets
 - 1¼" blind covers for unused boiler connections
 - M6x8x16 close tolerance bolts for fastening gas pipeline
 - Adjustable feet M8x35
2. Boiler connection set
 - Couplings and pipe branches
 - Isolation valves
 - Supply and drainage tap with T-piece;
3. Low velocity header
 - DN65 or DN100 Low velocity header with:
 - Adjustable feet, bolts, nuts, spring washers and gaskets
 - Automatic air vent, sensor pocket for T10 and drain valve
4. Frame (if stand-alone)
 - Assembly frame (for 1 boiler in line or 2 boilers back to back)
 - I-column(s)
 - L-column(s) (for back- to- back positioning)
 - Adjustable feet, bolts, spring washers and nuts
5. Parts such as: Bus communication cable, insulation sets, common flow sensor T10, etc.

4 Description

The Upsilon is a condensing and modulating CH-boiler.

The boiler has one or two stainless steel heat exchangers with smooth pipes. A high-tec principle with durable materials suitable for room sealed open flue or over pressure cascade flue systems

The CH-boiler uses (natural) gas to supply heat. This heat is transferred in the heat exchanger to the water contained in the CH-installation. Severe cooling down of the flue-gases causes condensation. That is the reason why they are so highly efficient. The internal syphon drains off the resulting condensate, which does not have a negative impact on the heat exchanger or its functioning.

The boiler is equipped with its own controller per heat exchanger and is fitted with an integrated cascade manager. The control unit (MMI) allows central read-outs of settings. Each boiler anticipates the heat demands of the CH-installation or the hot water supply. Consequently, the boiler modulates its capacity to the installation. As a result, the boiler will be operational longer at a lower level. The cascade manager controls the boiler order and even allocation of burning hours.

Connected to an external sensor, the control can operate weather dependent. This means that the control system measures outside temperatures and water flow temperatures. Using this data, the control system works out the optimum water flow temperature required for the installation.

Standard connection facilities for external controls via OpenTherm, on/off-contact or 0-10 volt control are available, including built in time program.

Upsilon CH-boilers are high-powered wall-mounted gas boilers for instances where a lot of power is required. Cascading the Upsilon CH-boilers provides ample room to connect up to a maximum of 8 boilers and an output capacity of 1.1 MW. The Upsilon-series is structured as follows:

- UB 70	Nominal capacity (80/60°C)	60.0kW
- UB 110	Nominal capacity (80/60°C)	95.0kW
- UB 140	Nominal capacity (80/60°C)	120.0kW

Explanation of type indication: Upsilon UB 140

Upsilon	= Serie	_____	_____
UB	= Type	_____	_____
140	= Indication of input load in kW	_____	_____

In principle any combination is possible. Based on the requested capacity, A.O.Smith's online cascade configurator offers various options.

You can choose either the most efficient or the most compact solution yourself.

The capacity of the hydraulic pipes, gas line and low velocity header are adjusted to the selected overall demand.



When installing a single Upsilon boiler of cascaded Upsilon boiler, you should always use a low velocity header adjusted to the set demand. A.O.Smith supplies 2 low velocity header versions, which are suitable for a maximum demand of either 452 kW or 960kW (80/60°C) respectively.



If changes are made to the boiler construction the boiler no longer complies with the CE requirements.

5 Installation and mounting



Install the boiler in a well-ventilated boiler room in accordance to the actual regulations.

The installation location of the CH-boiler(s) has to be, and remain, frost-free. It is NOT necessary to have a purpose provided air vent providing a twin pipe or concentric room sealed flue system is used in the room or internal space in which the boiler is installed. Neither is it necessary to ventilate the compartment in which the boiler is installed, due to the extremely low surface temperature of the boiler casing during operation. Therefore the requirements of BS 6798, Clause 12, and BS5440:2 may be disregarded.

The floor has to be flat and level and have sufficient deadweight capacity for the complete (filled) installation.

The Upsilon cascade can be mounted in 3 ways:

- Wall-mounted in line All boilers alongside one another on the wall
Refer to chapter 5.1 and 5.4
- free-standing in line All boilers hanging alongside one another on a free-standing frame. *Refer to chapter 5.2 and 5.4*
- free-standing back-to-back. All boilers hanging back-to-back on a free-standing frame. *Refer to chapter 5.3 and 5.4*



General guidelines:

Pay attention to the minimum distance required between the boilers, walls and ceiling for installing and removing the housing (refer to fig. 5.a.) for commissioning and servicing and installing the flue system (refer to chapter 7).

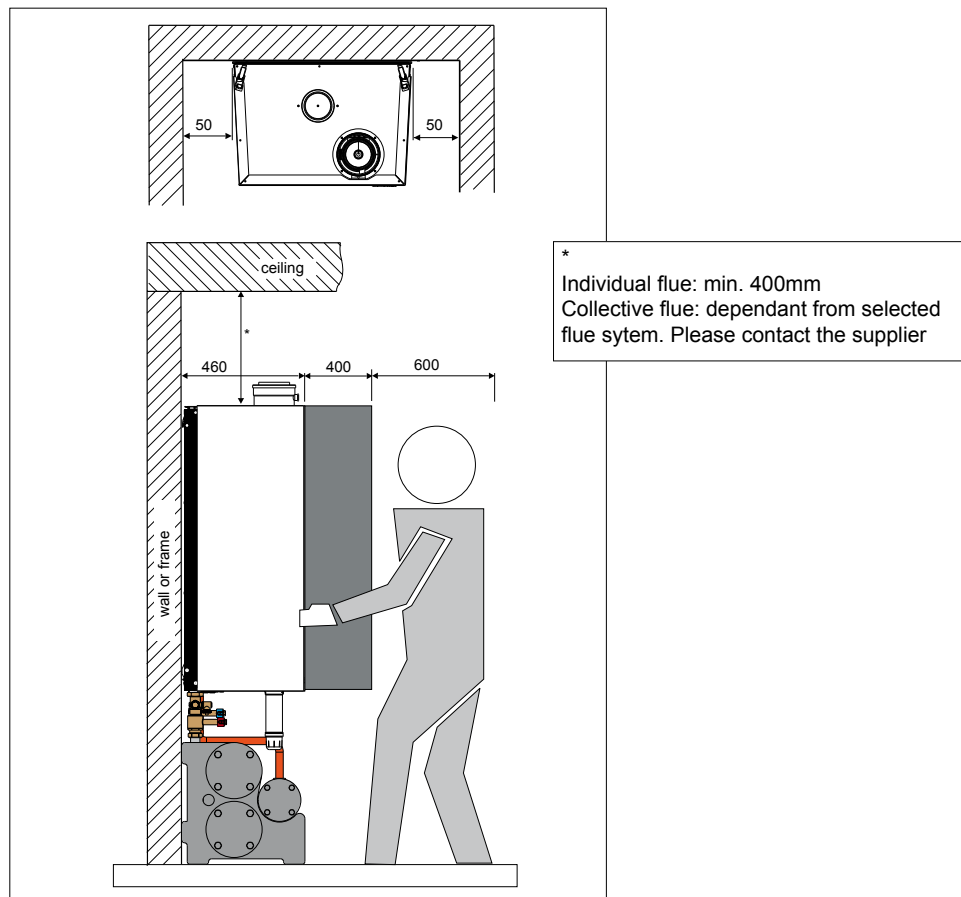

Figure 5.a

measurements in mm

5.1 Wall-mounted in line



Figure 5.1.a

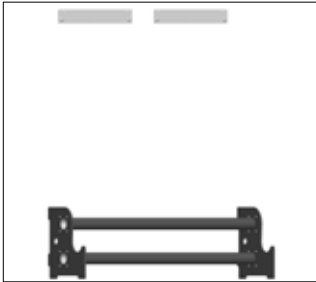

Figure 5.1.b

A. Position the pipe work header against the wall. When using several pipe work headers: couple the pipe work headers and supplied gaskets, M12 (DN65) or M16 (DN100) bolts, spring washers and nuts. Align the pipe work header(s) horizontally using the adjustable feet.

B. Determine the position of the suspension brackets based on figure 5.1.c. The boilers can be fitted on the wall using the supplied suspension brackets and mounting material (minimum of 3 screws for each boiler). The wall has to be flat and strong enough to carry the weight of all boilers including their water contents.

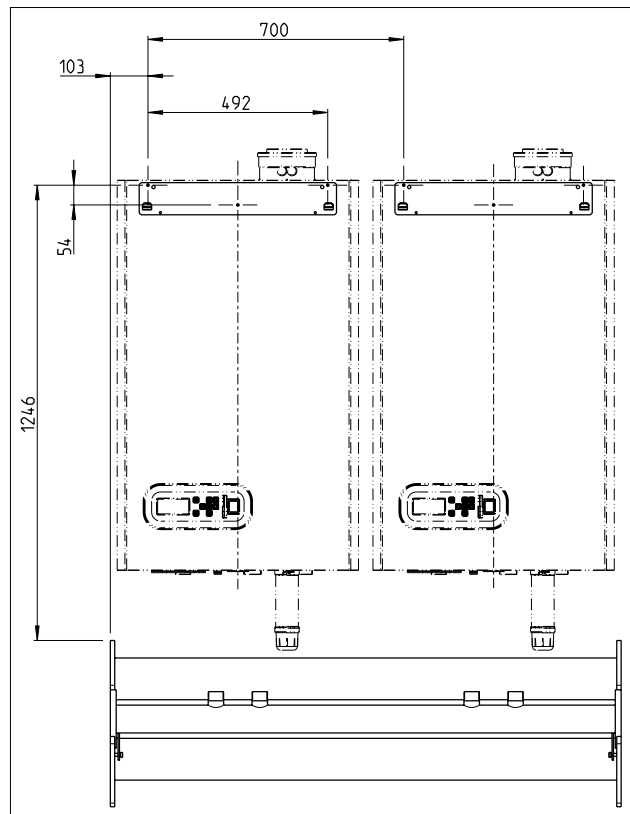

Figure 5.1.c

measurements in mm

C. Hang the boilers on the suspension brackets.

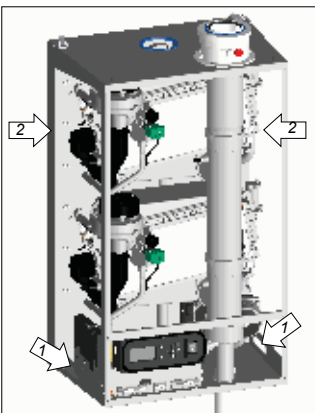

Figure 5.1.d



Lift the boiler only by the special grips on the bottom panel (1) and support the boiler by its rear panel (2). Refer to figure 5.1.d.

Lifting and carrying precautions:

- Lift only a manageable weight, or ask for help.
- When lifting the boiler, bend the knees, and keep the back straight and feet apart.
- Do not lift and twist at the same time.
- Lift and carry the boiler close to the body.
- Wear protective clothing and gloves to protect from any sharp edges.



Figure 5.1.e

D. Place the gas line in its intended recess. When using several pipe work headers: couple the gas lines using the supplied DN50/DN65 gaskets, M12 bolts, spring washers and nuts. Refer to figure 5.1.e.



Figure 5.1.f



Fasten the gas line with the 2 special close tolerance bolts M6x8x16 on each flange of the pipe work header(s). Refer to figure 5.1.f.

Continue with chapter 5.4

5.2 Free-standing in line



Figure 5.2.a

A. Position the pipe work header in the required location. When using several pipe work headers: couple the pipe work headers using the supplied gaskets, M12 (DN65) or M16 (DN100) bolts, spring washers and nuts. Align the pipe work header(s) horizontally using the adjustable feet.



Figure 5.2.b

B. Place the gas line in its intended recess. When using several pipe work headers: couple the gas lines using the supplied DN50/DN65 gaskets, M12 bolts, spring washers and nuts. Refer to figure 5.2.b.



Figure 5.2.c

⚠ Fasten the gas line with the 2 special close tolerance bolts M6x8x16 on each flange of the pipe work header(s). Refer to figure 5.2.c.



Figure 5.2.d

C. Fit the I-columns on the flange plate using 2x bolts M8x40x70mm.

Attention: Use the correct holes in the column!



When using a left flange plate: use the right-hand holes in the column.

When using a right-hand flange plate: use the left-hand holes in the column.

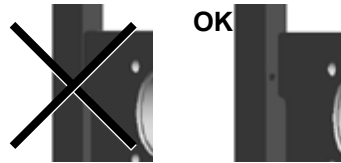

D. Fit a mounting frame on the I-column using 3-x bolt M8x50mm. Refer to figure 5.2.e.

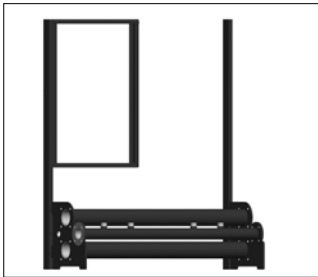
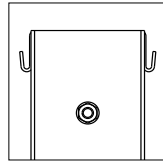

Figure 5.2.e



Attention: mounting rail at the top.



E. Fit a mounting frame on the other I-column using 3-x bolt M8x50mm. Refer to figure 5.2.f.

If boilers also have to be fitted on the other side of the I-column, then the next mounting frame also has to be fitted straight on it.



Figure 5.2.f

F. Fit the remaining I-column(s) between the mounting frames using 3x M8x50mm. Refer to figure 5.2.f.

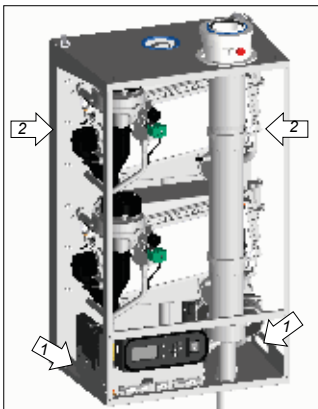

Figure 5.2.g

G. Hang the boilers on the mounting rail.



Lift the boiler only by the special grips on the bottom panel (1) and support the boiler by its rear panel (2). Refer to figure 5.2.g.

Lifting and carrying precautions:

- Lift only a manageable weight, or ask for help.
- When lifting the boiler, bend the knees, and keep the back straight and feet apart.
- Do not lift and twist at the same time.
- Lift and carry the boiler close to the body.
- Wear protective clothing and gloves to protect from any sharp edges.

Continue with chapter 5.4

5.3 Free-standing back-to-back

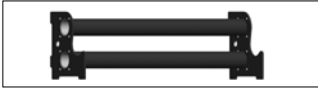

Figure 5.3.a

- A. Position the pipe work header in the required location. When using several pipe work headers: couple the pipe work headers with the supplied gaskets, M12 (DN65) or M16 (DN100) bolts, spring washers and nuts. Align the pipe work header(s) horizontally using the adjustable feet.



Figure 5.3.b

- B. Place the gas line in its intended recess. When using several pipe work headers: Couple the gas lines using the supplied DN50/DN65 gaskets, M12 bolts, spring washers and nuts. Refer to figure 5.3.b.



Figure 5.3.c

- ⚠ Attention:** Fasten the gas line with the 2 special close tolerance bolts M6x8x16 on each flange of the pipe work header(s). Refer to figure 5.3.c.



Figure 5.3.d

- C. Fit the L-columns on the flange plate using 2 x bolts M8x40x70mm.
⚠ Attention: Use the correct holes in the column!
When using a left flange plate: use the right-hand holes in the column.
When using a right-hand flange plate: use the left-hand holes in the column.

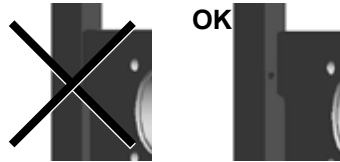

- D. Fit a mounting frame on the L-column using 3x bolt M8x50mm. Refer to figure 5.3.e.

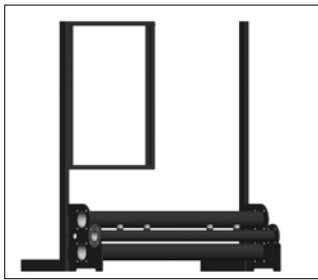
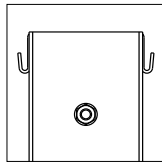

Figure 5.3.e

- ⚠ Attention:** mounting rail at the top.



- E. Fit a mounting frame on the other L-column using 3-x bolt M8x50mm. Refer to figure 5.3.f.
If boilers also have to be fitted on the other side of the L-column then the next mounting frame also has to be fitted straight on it.



Figure 5.3.f

- F. Fit the remaining L-column(s) between the mounting frames using 3x M8x50mm. Refer to figure 5.3.f.

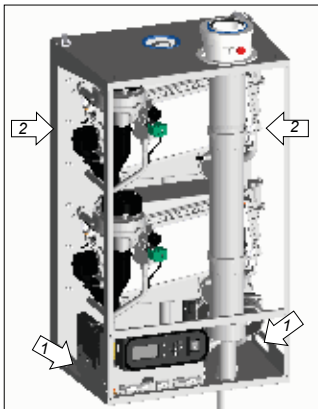

Figure 5.3.g

- G. Hang the boilers on the front and rear of the frame on the mounting rail.

- ⚠ Attention:** Lift the boiler only by the special grips on the bottom panel (1) and support the boiler by its rear panel (2). Refer to figure 5.3.g.

Lifting and carrying precautions:

- Lift only a manageable weight, or ask for help.
- When lifting the boiler, bend the knees, and keep the back straight and feet apart.
- Do not lift and twist at the same time.
- Lift and carry the boiler close to the body.
- Wear protective clothing and gloves to protect from any sharp edges.

Continue with chapter 5.4

5.4 Connecting the boiler

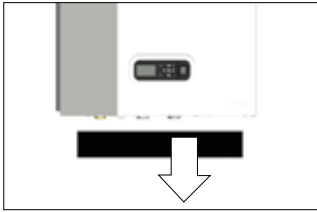

Figure 5.4.a

- A. Remove the remaining packaging part from the bottom of the boiler.



Note: this packaging part is provided with boiler parts which are needed for mounting the boiler.

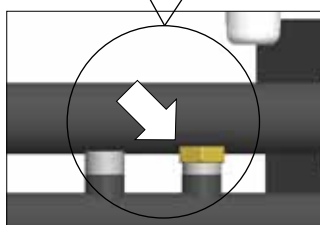

Figure 5.4.b

- B. Cap the connections that are not used on the pipe work headers:

Flow and return:	ø35mm blind compression fitting	(2 items/boiler)
Gas:	1 ¼" blind cap with gasket	(1 item/boiler)



For connections, use the supplied gaskets. Check all connections for leakage and gas-tightness.

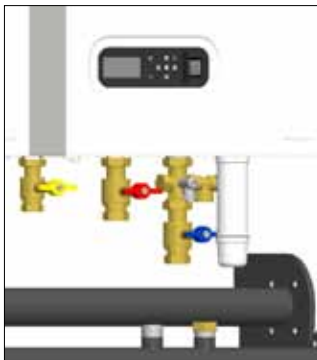

Figure 5.4.c

- C. Connect the isolations valves to the boiler:

Flow: 1½" flat coupling x 35mm compression isolation valve with red handle

Return: 1½" flat coupling x 35mm compression fitting cross union with fill/drain valve and isolation valve

Fit according to the installation design choice the supplied 3 or 4 bar overflow safety valve in the cross union.

Gas: 1¼" x 28mm gas isolation valve



Polluted test water may be released when removing the plastic caps on the boiler flow and return.



For connections, use the supplied gaskets. Check all connections for leakage and gas-tightness.

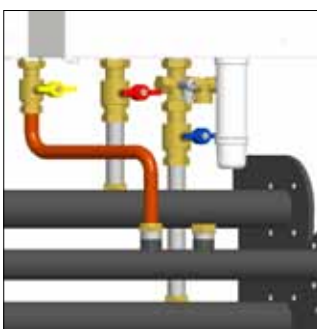

Figure 5.4.d

- D. Connect the valves to the pipe work headers:

Flow: 35mm pipe pieces with 35mm compression fittings (elbow and socket)

Return: 35mm pipe pieces with 35mm compression fittings (elbow and socket)

Gas: 28mm pipe piece with 1¼" flat and 28mm compression fitting

Back-to-back installation:

Flow: 35mm pipe pieces with 35mm compression fittings (bend and socket)

Return: 35mm pipe pieces with 35mm compression fittings (bend and socket)

Gas: 28mm pipe piece with 1¼" flat and 28mm compression fitting



For connections, use the supplied gaskets. Check all connections for leakage and gas-tightness.

- E. Fill the siphon with tap water and fit the siphon cup underneath the boiler.
The siphon cup is supplied separately and can be found behind the housing.

6 Hydraulic and gas pipe line system

6.1 Heating system

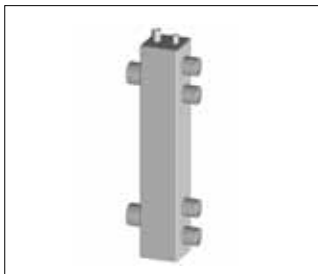

Figure 6.1.a

Install the CH-system in accordance with present legislation.

The pipe work headers are available in 2 dimensions, i.e. DN65 and DN100 and are connected to one another by the flange couplings and gaskets, M12 or M16x55 bolts, spring washers and nuts. The low velocity header and the complete installation can then be connected to it.

Low velocity header

There are 3 low velocity headers available:



Figure 6.1.b

0310335 Low velocity header for 1 or 2 XL boilers to max. 200kW (fig. 6.1.a)
Boiler connections are 4x 1 1/2", installation connections are 2x 2". The low velocity header must be suspended in the pipework. Supplied with automatic air vent, drain valve and pocket for temperature sensor T10.

0310272 Low velocity headers DN65 to 452kW (fig. 6.1.b)

0310273 Low velocity headers DN100 to 960kW

The low velocity headers comes standard with adjustable feet, automatic air vent, drain valve, pocket for temperature sensor T10, M12 or M16x55 bolts, spring washers and nuts. The low velocity header can be positioned on either the left or right hand side of the pipe work headers.



Figure 6.1.c

0310290 Temperature sensor T3/T10 (fig. 6.1.c)



Every system with 1 or more UB-boilers must be provided with a flow temperature sensor T10 and must be connected on the master boiler (address 01) to terminal 3, position 5 and 6. The flow sensor must be placed in the pocket of the low velocity header.



Figure 6.1.d

Set of bends

The low velocity header can be positioned at a 90° angle. A set of bends may be used for that purpose.

0310274 Bends set DN65 flow/return (fig. 6.1.d)

0310275 Bends set DN100 flow/return

Blanking flanges

The ends of the pipe work headers have to be fitted with blanking flanges. The blanking flanges come standard with a fully configured delivery, including bolts, spring washers and gaskets.

0310276 Blanking flange set DN65 flow/return 2 items (fig. 6.1.e)

0310277 Blanking flange set DN100 flow/return 2 items



Figure 6.1.e

Welded-on flanges

Upon request, welded-on flanges are available to connect CH-pipe lines to the secondary side of the low velocity header and to connect the gas line.

0310336 Welded-on flange set DN65 flow/return 2 items + DN50 gas 1 item (fig. 6.1.f)

0310337 Welded-on flange set DN100 flow/return 2 items + DN65 gas 1 item



Figure 6.1.f

Required components that are not supplied by A.O.Smith:

- The installation pump;
- The installation water filter;
- Gas filter;
- Regulation valve;
- The condensate discharge system.
- Air and dirt separator
- Hot water supply

6.2 Expansion vessel

The CH-installation has to be fitted with an expansion vessel. The expansion vessel used has to comply with the water contents of the installation.

It is not necessary to install an expansion vessel to each boiler. One single, central installed expansion vessel is sufficient. When using a single expansion vessel the handles of the valves on the flow and return pipes below the boiler have to be removed whilst open.

A boiler expansion vessel can be connected on the cross union inside the return pipe to each boiler, if required. The connection is fitted with a 3/4" outer thread blanking cap.

6.3 Water quality

Fill the installation with drinking water.



In most cases, a heating system can be filled with water according to national standards for water and treatment of this water is not necessary.

In order to avoid problems with the CH-installations, the quality of the filling water has to meet the specifications mentioned in table 6.3.a:

If the filling water does not meet the required specifications, you are advised to treat the water to such an extent that it does meet the required specifications.

The warranty becomes invalid, if the installation is not being flushed and/or the quality of the filling water does not meet the specifications recommended by A.O.Smith. Always contact A.O.Smith in advance, if things are not clear or you wish to discuss any deviations. Without approval, the warranty becomes invalid.

Installation:

- The use of groundwater, demi-water and distilled water is prohibited. (on the next page you will find an explanation of these definitions)
- If the drinking water quality meets the specifications mentioned in table 6.3.a, you can start flushing the installation before installing the boiler(s).
- Whilst flushing, corrosion products (magnetite), fitting products, cutting oil and other undesirable products have to be removed.
- Another possibility is to remove the pollution by installing a filter. The filter type has to fit the type and grain size of the pollution. A.O.Smith recommends filter usage.
- In this case, the whole piping system should be taken into consideration.
- The CH-installation has to be properly vented before using the system. For that purpose, we refer to the commissioning chapter.
- If a regular water top up is required (>5% on an annual basis), then there is a structural problem and an installer has to solve the problem. Adding regularly fresh water to the system also adds additional calcium and oxygen implying that magnetite and calcium residues can continue. The result may be blockages and/or leakages.
- The use of anti-freeze and other additives requires periodical quality checks of the filling water in accordance with the period laid down by the additives supplier.
- Chemical additions are to be avoided and should only be used after A.O.Smith has approved their corresponding use.
- Should you wish to achieve the required water quality by using chemical additives, then this is your own responsibility. The warranty on the product delivered by A.O.Smith expires, if the water quality does not meet A.O.Smith's specifications or the chemical additives have not been approved by A.O.Smith.

- On installation and during additions or changes at a later stage, A.O.Smith recommends to keep a record of the type of water used, its quality at the time, and if applicable, which additives and quantities were added.

Parameter	Value
Water type	Potable water Softened water
pH	6.0-8.5
Conductivity (at 20°C in µS/cm)	Max. 2500
Iron (ppm)	Max. 0.2
Hardness (°dH):	
Installation volume/capacity <20 l/kW	1-12
Installation volume/capacity ≥20 l/kW	1-7
Oxygen	No oxygen diffusion allowed during operation. Max. 5% filling water addition annually
Corrosion inhibitors	Refer to Additives Attachment
pH increasing or lowering agents	Refer to Additives Attachment
Anti-freeze additives	Refer to Additives Attachment
Other chemical additives	Refer to Additives Attachment
Solid substances	Not allowed
Residues of processing water not forming part of the drinking water	Not allowed

table 6.3.a

Water type definition:

- Potable water: Tap water compliant with the European drinking water guideline: 98/83/EG dated 3 November 1998.
- Softened water: Water with partly de-ionised calcium and magnesium.
- Demi-water: Virtually completely demineralised water (very low conductivity)
- Distilled water: Water no longer containing minerals.

6.4 Gas line

Mount the gas line in accordance with present legislation.
If required, mark the gas line in accordance with present legislation.

United Kingdom:

The gas supply must comply to the current Gas Safety, Installation & Use Regulations.

Ireland:

- Irish standard 813
- Domestic gas installations

The gas line leading to the installation has to be calculated to the maximum capacity to determine the diameter of the supply pipe.

The gas line has to be placed on the allocated openings of the flange plates of the pipe work headers flow/return and secured on all flange plates by the special M6x8x16 close tolerance bolts.

Pressure loss for a newly installed natural gas line may be 1.7 mbar max. In the case of an extension, this may be 2.5 mbar max. This value is to be measured in between the operational gas meter and the CH-boilers.

For correct functioning of the boilers, it is necessary that the gas dynamic inlet pressure must be at least 19 mbars.



With regard to new lines in particular, ensure that the gas line does not contain any residual pollution.

The Upsilon boilers can be converted from natural-gas to propane/lpg and from propane/lpg to natural-gas. When the boiler has to be converted, A.O. Smith provides special kits for this purpose. Special instructions are supplied with the kit.



The lpg-gas has to have a propane purity of at least 90%. When the butane-level is greater then 10% the warranty conditions on the heat exchangers are not valid.



Following maintenance tasks always check all gas carrying components for leakages by using leakage detection spray.

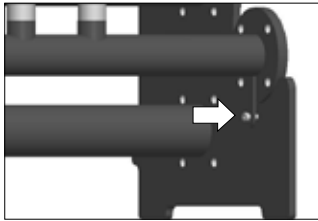

Figuur 6.4.a

6.5 Condensate drain

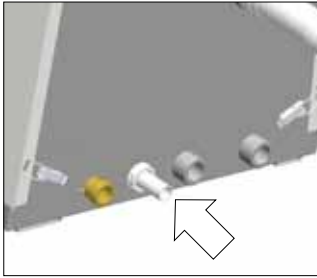

Figuur 6.5.a

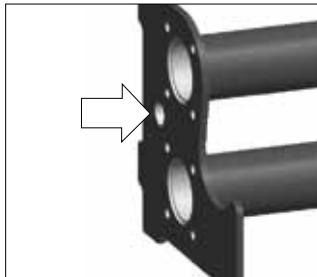

Figuur 6.5.b

All A.O.Smith wall hung gas fired condensing boilers contain a syphonic condensate trap to collect and release condensate.

The amount of condensate formed is determined by the type of boilers and the water temperature produced by the boiler.

Condensate pipework.

Press the supplied plastic ribbon tube onto the condensate drain at the bottom of the boiler (fig. 6.5.a). Connect the tube to the main condensate drain (minimum diameter=40mm) by means of an open connection to avoid sewage gasses coming into the boiler.

Fit a pipe work header for the condensate drain behind the hydraulic system. For that purpose, the flange plates have holes allowing the installation of a PVC drain of $\varnothing 40\text{mm}$ max. Use this drain to connect the individual condensate drains of each boiler.

The syphon of a flue gas system can also be connected, if required, by means of an open connection.

Routing of the pipework.

Wherever possible, the condensate pipework should be routed internally to prevent freezing.

The condensate pipework must fall at least 50mm per metre towards the outlet and take the shortest possible route

Support the pipe at least every 50 cm for near horizontal sections and 1 metre for vertical sections

External pipework

The pipework should be kept to a minimum and the route as vertical as possible. Do not exceed 3 metres outside the dwelling.

The condensate pipe must be run using suitable corrosion resistant materials (eg. plastic).

Terminate as close to the ground or drain as possible (below the grating and above the water level) while still allowing for safe dispersal of the condensate.

Connection of a condensate drainage pipe to a drain may be subject to local building controls.

Pipework subjected to extreme cold or wind chill conditions should be in a 40mm diameter pipe.

Protect all external pipework with weather resistant insulation and, if necessary, box in, to reduce the risk of freezing.

Making it safe.

Condensate pipework must not leak, freeze or block up.

Condensate traps must be filled before firing the boiler to prevent the possibility of potential harmful flue products evacuating via the condensate route.

Do not dispose condensate into a water recovery system where it is reclaimed for reuse.

Condensate can be discharged into a rainwater hopper which is part of a sewer carrying both rain water and foul water.

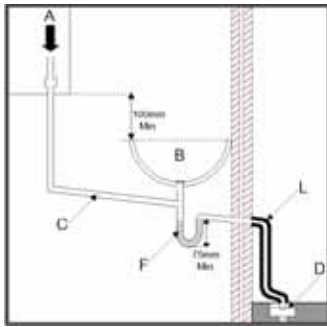

Final discharge options.

The condensate pipe can only terminate into any one of the five areas as shown in the diagrams on this page.

⚠ Draining of the condensation water to the external rain guttering is not permitted in view of the danger of freezing.

⚠ Before putting the boiler into operation fill the syphon with 600 ml of water.

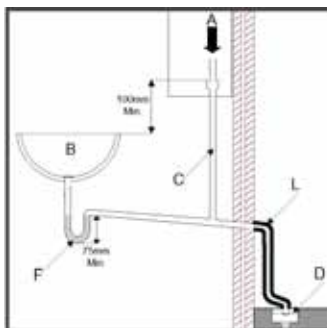
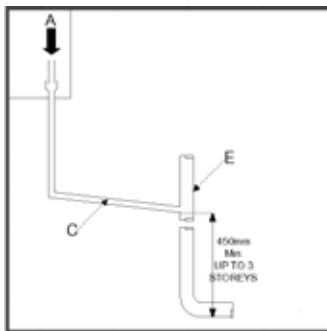
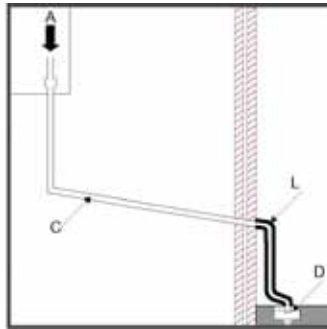

- A -Condensate from boiler syphon/trap
- B -Sink with internal overflow
- C -25mm dia. Plastic condensate pipe
- D -External drain or gully
- E -Internal soil and vent stack.
- F -Serviceable condensate trap (75mm min.)
- G -300mm x 100mm dia. sealed plastic tube.
- H -Ground level
- J -Drainage holes facing away from the building
- K -Lime stone chippings
- L -Weather resistant insulation

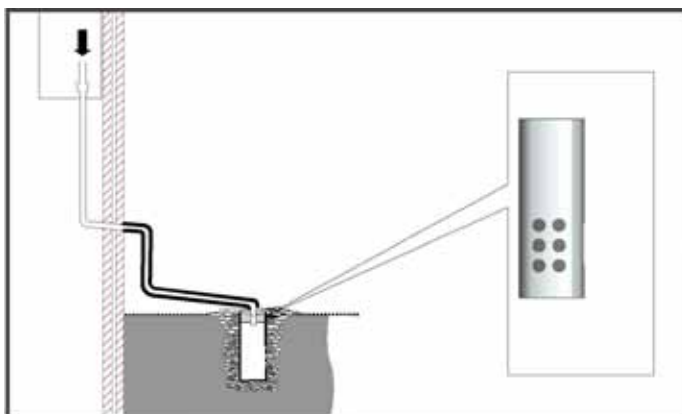

Drain requirements

figure 6.4.c

7 Flue gas system

The flue gas exhaust system and air supply system consists of:

- Flue gas pipe;
- Air supply pipe;
- Roof or wall terminal.

The flue gas exhaust system and air supply system must comply with:

United Kingdom:

The flue gas outlet and air supply installation must comply with the current regulation requirements. IG UP 10, BS 715 and BS 6644.

Ireland:

- Irish standard is 813 section 9.10.1



Furthermore:

- **Boiler Class indicated on the boiler's type plate (Flue category)**
- Locally applicable rules.
- The supplier's installation instructions



When in doubt or if you have any questions, always contact A.O.Smith.

The boiler can be fitted with a parallel connected flue gas outlet and air supply system (the connection diameter for both channels is $\varnothing 100\text{mm}$) or a concentric flue gas outlet and air supply system. In that case, the connection diameter is $\varnothing 100/150\text{mm}$. Refer to chapter 7.1 or 7.2.

7.1 Parallel boiler connection

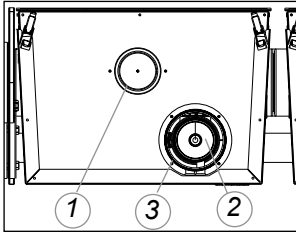

Figure 7.1.a

The boiler comes as standard with a parallel connection for the flue gas outlet and air supply system.

The air supply opening (1) has a diameter of $\varnothing 100\text{mm}$.

The air supply channel can be connected to it, or, if it involves an “open device” (Drainage category B), an air filter can be connected (recommended).

The air supply (3) of the concentric part is closed by a lid $\varnothing 150\text{mm}$.

The flue gas outlet connection (2) has a diameter of $\varnothing 100\text{mm}$.

7.2 Concentric boiler connection

Carry out the following tasks to convert the boiler to a concentric connection.

- Remove the lid $\varnothing 150$ (3) from the air supply connection of the concentric connection component (2).
- Fit the lid $\varnothing 100$ on the air supply opening (1) and secure it with the screw (all parts are delivered separately in the foam wrapping underneath the boiler)

The air supply opening has a diameter of $\varnothing 150\text{mm}$.

The flue gas outlet connection has a diameter of $\varnothing 100\text{mm}$.

The flue gas outlet-/air supply system is then connected to the concentric connection component.

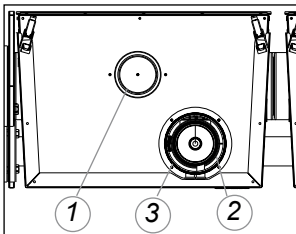

Figure 7.2.a

7.3 Connecting the flue gas outlet-/air supply system

Upsilon-boilers can be used both in an "open" and in "closed" system.

Open: The required combustion air is taken from the immediate environment (boiler room). For this purpose, please comply with the applicable boiler room ventilation regulations BS 6644.



When using boiler category B23 and B33 as an 'open boiler', the protection degree of the boiler will be IPX0D instead of IPX4D.

A.O.Smith recommends the application of an air filter on the air intake of the boiler (available as an accessory with art.nr. 0310288). If no filter is placed there must be a device (eg. grid) on the air intake of the boiler to be constructed or fitted such a way that an object with a diameter Ø 16 mm cannot be pushed in.

Closed: The required combustion air is sucked in from the outside through a channel. This improves installation possibilities within a building. In general, outside air is cleaner than air from the boiler room.

The following flue gas outlet systems can be used for the Upsilon-boiler:

- Individual flue gas outlet
- Collective flue gas outlet under-pressure
- Collective flue gas outlet over-pressure

7.4 Individual flue gas outlet

Opting for an individual flue gas outlet is determined by:

- Favourable position of boilers with regard to outlet area (wall or roof)
- Limited space above the boilers
- Limited number of boilers

You may opt for:

- Roof terminal (pitched or flat roof)
- Wall terminal



When the boiler is operational, it produces a white plume of condensation. This condensation plume is harmless but may cause some inconvenience, particularly in the case of wall terminal. As a result, roof terminals are preferred.



In a closed installation, roof terminals should be at the same height preventing flue gas from being sucked in by the other boiler (recirculation). Outlets in recesses and near erected walls may also bring about flue gas recirculation. Recirculation has to be prevented at all times.

A.O.Smith supplies the following roof and wall ducts:

0304264 Roof terminal Ø100 - 150

0302505 Wall terminal Ø100 - 150

Accessory options:

0306017 Lead roof tile ø150 for angled roof

0302509 Roof connection plate ø150 for flat roof

We suggest you design a simple flue gas system and air supply system. For further information about the available components of the flue gas and air supply system we recommend you consult the A.O.Smith flue literature.

The A.O.Smith flue gas system is meant, and designed, solely for the use on A.O.Smith central heating boilers adjusted to Nat gas or LPG. The maximum flue gas temperatures are below 70°C (full load 80/60°C)

The proper operation may be adversely influenced by changes of or adjustments to the correct set up.

Possible warranty claims will not be honoured if incorrect changes result in non compliance with the installation manual or local rules and regulations.

The flue gas system should be built up using only A.O.Smith program products. Combinations with other brands or systems are, without written permission from A.O.Smith, not permitted.

The terminal should be located where dispersal of combustion products is not unimpeded and with due regard for the damage or discolouration that might occur to parts of the building in the vicinity (see fig 7.4.a).

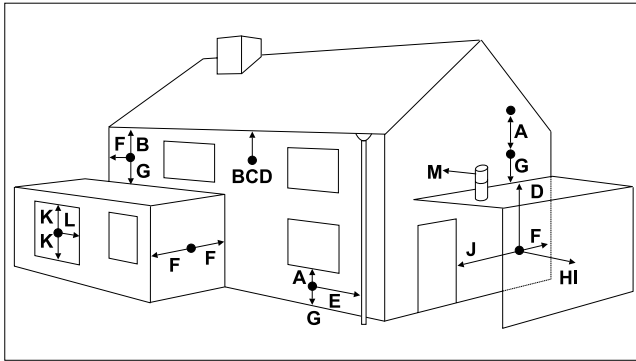

figure 7.4.a

terminal position for fan assisted boiler		minimum distance
A	directly below an open window or other opening (e.g. air brick)	mm 300
B	below gutters, soil pipes or drain pipes	mm 75
C	below eaves	mm 200
D	below balconies or car port roof	mm 200
E	from vertical drain pipes and soil pipes	mm 75
F	from internal or external corners	mm 300
G	above ground or below balcony level	mm 300
H	from a surface facing a terminal	mm 600
I	from a terminal facing a terminal	mm 1200
J	from an opening in the car port (e.g. door window) into dwelling	mm 1200
K	vertically from a terminal on the same wall	mm 1500
L	horizontally from a terminal on the same wall	mm 300
M	horizontally from a vertical terminal to a wall	mm 300

Dimensions

table 7.4.a

In certain weather conditions condensation may also accumulate on the outside of the air inlet pipe. Such conditions must be considered and where necessary insulation of the inlet pipe may be required.

In cold and/or humid weather water vapour may condense on leaving the flue terminal. The effect of such 'pluming' must be considered.

The terminal must not be located in a place where it is likely to cause a nuisance. For protection of combustibles, refer to IS 813 section 9.10.1. where the terminal is less than 2m (6.6ft) above a pavement or platform to which people have access (including) any balcony or flat roof. The terminal must be protected by a guard of durable material. Contact A.O. Smith for a suitable guard.



Where a terminal is fitted below a window which is hinged at the top, and where the hinge axis is horizontal, and the window opens outwards, the terminal shall be 1m below the bottom of the window opening.



If the boiler is to be located under stairs, a smoke alarm meeting the requirements of I.S. 409 or equivalent must be fitted.



The flue must be terminated in a place not likely to cause a nuisance.

For horizontal sections, the outlet system should always be fitted on an incline (50 mm/m) sloping down towards the appliance so that no condensation water is able to accumulate in the outlet system. The chances of icicles forming on the roof outlet is minimised by causing the condensation water to run back towards the appliance. In the case of horizontal outlets the inlet system should be fitted on an incline sloping down towards the outside to prevent rainwater from coming in.

The appliance produces a white wisp of condensation (pluming). This wisp of condensation is harmless, but can be unattractive, particularly in the case of outlets in outside walls.

At this time there are 2 different ways of connecting the flue gas/air intake system, parallel or concentric. See chapter 7.1 and 7.2 how to convert the boiler connection to the desired option.

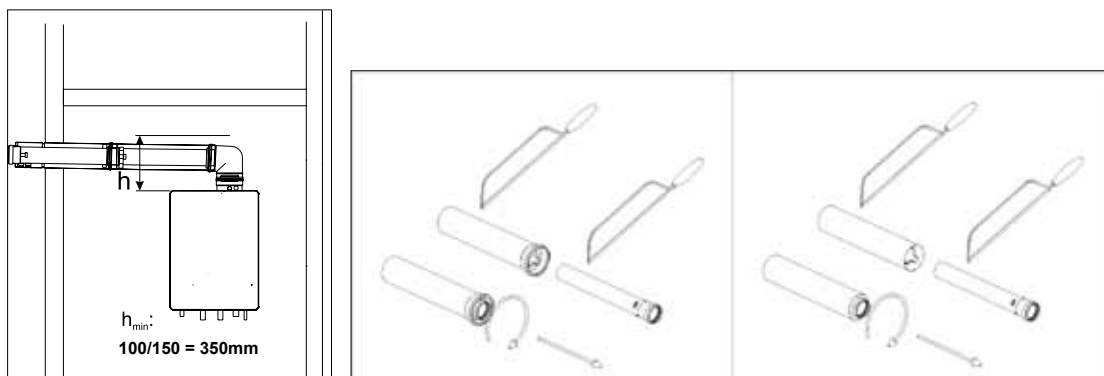

Dismantlement and shorten pipes

figure 7.4.b

Cutting the concentric pipe goes as follows:

- Take out the inner tube by turning it until it releases from its security position;
- Cut just as much from the air intake part as from the flue gas part;
- Take off the burrs from the cutting edge to prevent cutting the seals;
- Click the pipes back together again.

Use special grease to simplify the fitting

When mounting the flue gas system, pay attention to the flow direction. An arrow on the product points this out. It is not permitted to mount a system upside down and will lead to complaints.

Refer to table 7.4.b for maximum applicable pipe length.

Example:

An UB 70 with a concentric flue gas system $\phi 100/150\text{mm}$ has according to the table a maximum flue straight length of 25m. In the system that is going to be put in there are 2 x 45° bends, so the maximum flue gas length is $25 - (2 \times -1.1) = 22.8$ meters.

		Parallel flue system	
		$\phi 100\text{mm}$	A in m
UB 70		Maximum straight length 100	63
		87° bend resistance length	-1,8
		45° bend resistance length	-0,9
		Maximum straight length 100	35
UB 110		87° bend resistance length	-1,8
		45° bend resistance length	-0,9
		Maximum straight length 100	12
UB 140		87° bend resistance length	-1,8
		45° bend resistance length	-0,9
		Concentric flue system	
		$\phi 100/150\text{mm}$	B in m
UB 70		Maximum straight length 100/150	25
		87° bend resistance length	-2,6
		45° bend resistance length	-1,1
		Maximum straight length 100/150	15
UB 110		87° bend resistance length	-2,6
		45° bend resistance length	-1,1
		Maximum straight length 100/150	8
UB 140		87° bend resistance length	-2,6
		45° bend resistance length	-1,1

Maximum flue length for individual flue gas outlet

table 7.4.b

7.5 Collective flue gas outlet

Opting for a collective flue gas outlet is determined by:

- The position of the boilers with regard to their outlet area
- Sufficient space above the boilers
- Large number of boilers

You may opt for:

- Collective flue gas outlet under-pressure
- Collective flue gas outlet over-pressure

In many situations, flue gases cannot be vented individually because the installation is indoors. For such situations, we recommend collective venting by means of under-pressure or over-pressure using a flue gas outlet system. The air supply may also be supplied collectively, but if the boiler room is suitable for that purpose (refer to chapter 6.3) it may also be obtained from this area ('open device' Boiler category B).

⚠ In the case of collective venting of flue gases, the flue gas-venting outlet always has to end up in the open area (outlet area 1).

A.O.Smith can supply a collective flue gas outlet system for the Upsilon boiler. Refer to the following chapters with regard to the various possibilities and maximum pipe lengths that can be used.

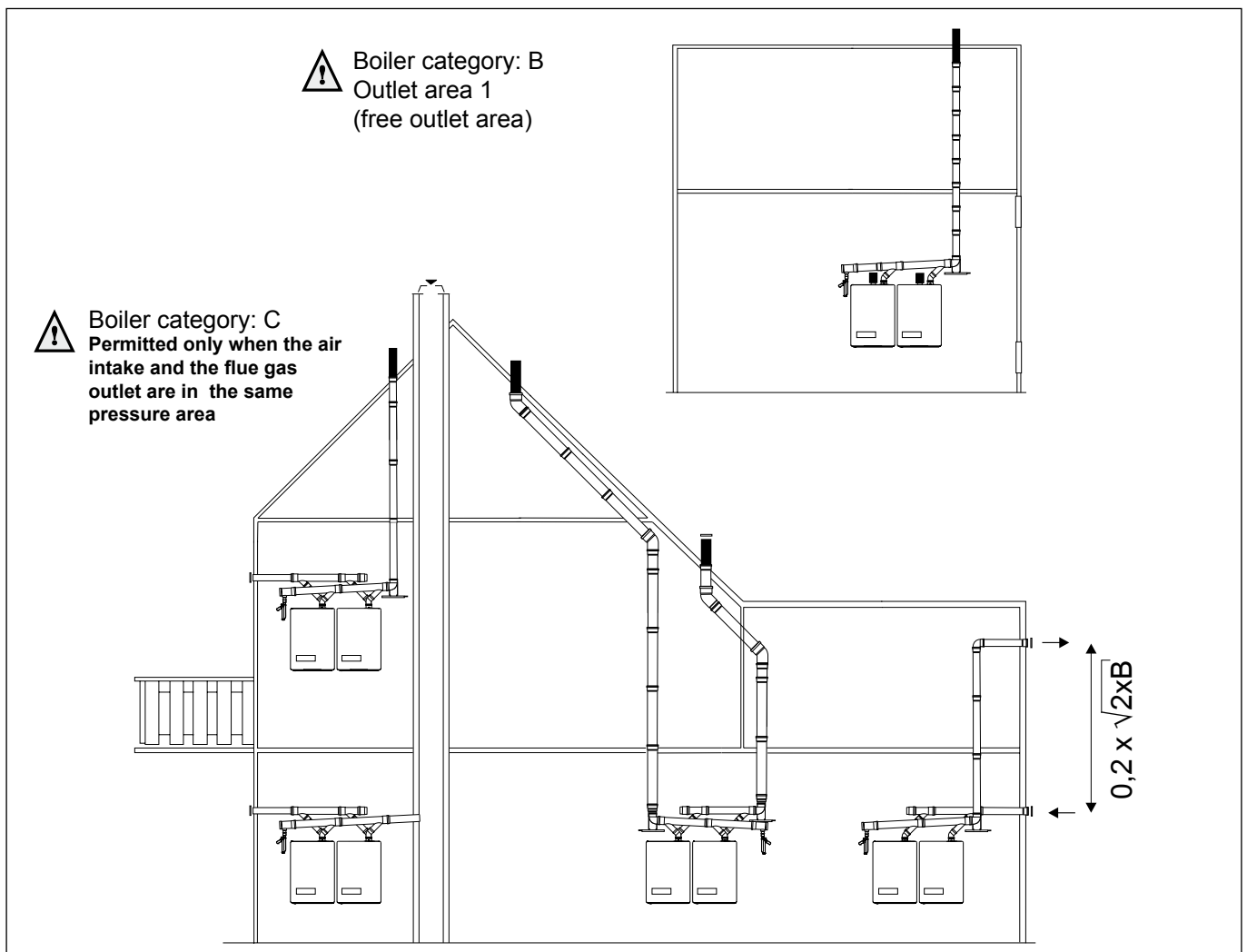

Flue outlet possibilities collective flue gas outlet

figure 7.5.a

7.5.1 Collective flue gas outlet under-pressure

Diameter and venting lengths of the flue gas outlet/air supply:

- Open system, with under-pressure (calculated with thermal draft) under atmospheric circumstances.

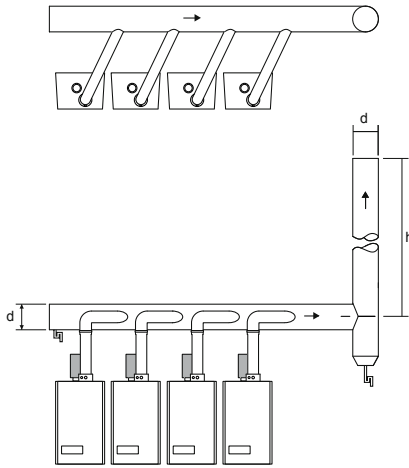

NOTE!
1. IPX0D at flue category B₂₃ and B₃₃

Table 7.5.1.a

Dimensions cascade flue Upsilon Open system, underpressure							
Output (P) kW at 80/60°C	Type UB			d = minimum diameter Ø in mm			
	70	110	140	h = 2 - 5	h = 5 - 9	h = 9 - 13	h = 13 - 17
152	1	1		210	200	190	190
180	1		1	210	200	190	190
212		1	1	210	200	190	190
240			2	210	200	190	190
272	1	1	1	300	270	260	250
300	1		2	300	270	260	250
332		1	2	300	270	260	250
360			3	300	270	260	250
392	1	1	2	360	330	310	300
424		2	2	360	330	310	300
452		1	3	360	330	310	300
480			4	360	330	310	300
512	1	1	3	440	380	360	340
544		2	3	440	380	360	340
572		1	4	440	380	360	340
600			5	440	380	360	340
632	1	1	4	470	420	400	380
660	1		5	470	420	400	380
692		1	5	470	420	400	380
720			6	470	420	400	380
752	1	1	5	550	470	430	410
784		2	5	550	470	430	410
812		1	6	550	470	430	410
840			7	550	470	430	410
872	1	1	6	600	510	470	440
900	1		7	600	510	470	440
932		1	7	600	510	470	440
960			8	600	510	470	440

Assumptions: Trega-cap on flue outlet, cross-cap on air intake.

In case of open outlet or diffuser pressures will be better.

Tinside, Toutside= + 20C, O2= 4,7%, Trg=50C.

Diameter and venting lengths of the flue gas outlet/air supply:

- Closed system, with under-pressure (calculated with thermal draft) under atmospheric circumstances.

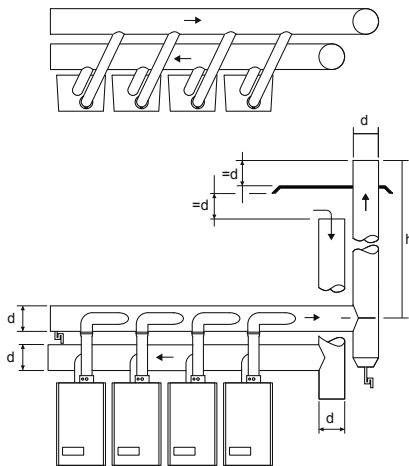

Table 7.5.1.b

Dimensions cascade flue Upsilon Closed system, underpressure, parallel							
Output (P) kW at 80/60°C	Type UB			d = minimum diameter Ø in mm			
	70	110	140	h = 2 - 5	h = 5 - 9	h = 9 - 13	h = 13 - 17
152	1	1		240	220	220	220
180	1		1	240	220	220	220
212		1	1	240	220	220	220
240			2	240	220	220	220
272	1	1	1	330	300	290	270
300	1		2	330	300	290	270
332		1	2	330	300	290	270
360			3	330	300	290	270
392	1	1	2	390	370	350	330
424		2	2	390	370	350	330
452		1	3	390	370	350	330
480			4	390	370	350	330
512	1	1	3	460	410	390	380
544		2	3	460	410	390	380
572		1	4	460	410	390	380
600			5	460	410	390	380
632	1	1	4	500	460	440	420
660	1		5	500	460	440	420
692		1	5	500	460	440	420
720			6	500	460	440	420
752	1	1	5	550	500	470	460
784		2	5	550	500	470	460
812		1	6	550	500	470	460
840			7	550	500	470	460
872	1	1	6	600	540	510	490
900	1		7	600	540	510	490
932		1	7	600	540	510	490
960			8	600	540	510	490

Assumptions: Trega-cap on flue outlet, cross-cap on air intake.

In case of open outlet or diffuser pressures will be better.

Tinside, Toutside= + 20C, O2= 4,7%, Trg=50C.

7.5.2 Collective flue gas outlet over-pressure



An installation with a collective flue gas outlet over-pressure in combination with individually controlled boilers (e.g. 0-10 V control), where no bus cable 0310289 is connected, is NOT allowed.

Diameter and venting lengths of the flue gas outlet/air supply:

- Open system with over-pressure.

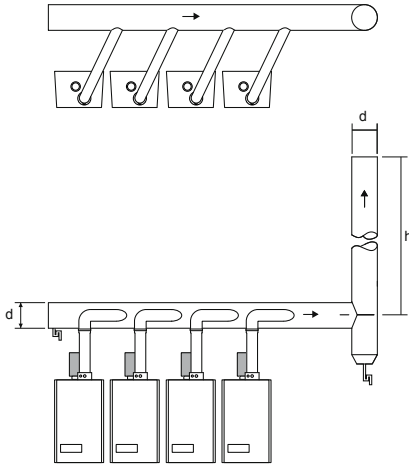

NOTE!

1. IPX0D at flue category B₂₃ and B₃₃
2. Only with bus cable 0310289 connected!
3. Adjust parameter 102 to 2

Output (P) kW at 80/60°C	Dimensions cascade flue Upsilon Open system, overpressure, parallel						
	Type UB			d = minimum diameter Ø in mm			
	70	110	140	h = 2 - 5	h = 6 - 10	h = 11 - 15	h = 16 - 20
152	1	1		100	100	110	110
180	1		1	120	120	130	130
212		1	1	120	130	130	150
240			2	120	130	150	150
272	1	1	1	150	150	180	180
300	1		2	150	180	180	180
332		1	2	180	180	180	180
360			3	180	180	180	180
392	1	1	2	180	180	180	200
424		2	2	200	200	200	220
452		1	3	200	220	220	220
480			4	200	220	220	220
512	1	1	3	200	220	220	220
544		2	3	220	230	230	230
572		1	4	230	230	250	250
600			5	230	230	250	250
632	1	1	4	230	230	250	250
660	1		5	250	250	250	250
692		1	5	260	260	260	260
720			6	280	280	280	280
752	1	1	5	280	280	280	280
784		2	5	280	280	280	280
812		1	6	280	280	280	280
840			7	280	280	280	280
872	1	1	6	280	280	280	280
900	1		7	280	280	280	300
932		1	7	300	300	300	300
960			8	300	300	300	300

Table 7.5.2.a

Pa = 50Pa

Diameter and venting lengths of the flue gas outlet/air supply:

- Closed system with over-pressure.

Please contact A.O.Smith.

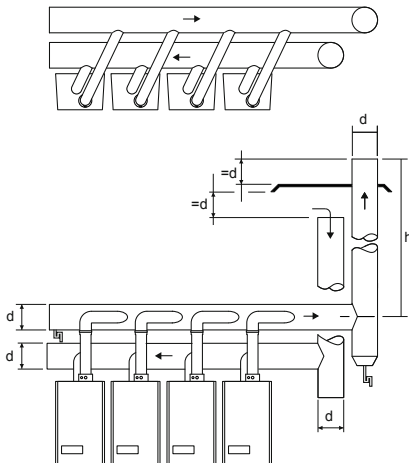

7.6 Condensate vent collective flue gas outlet system

Flue gases condensate inside the outlet system. Anticipate approx. 1 litre of condensate per m³ of natural gas spent on heating. The resulting condensate has to be drained.

Therefore, collective flue gas outlet systems have to be fitted with a condensate drainage facility. Using a plastic siphon, the drainage is connected to the sewage system by means of an open connection. The diameter of the condensate drainage is 40 mm and may be made of PVC.

The condensate drainage of the flue gas vent system may be combined with the boilers' condensate pipe work headers.



Draining condensate water on the rainwater drainage is not allowed due to the risk of freezing.

8 Electrical connections

The appliance complies with the CE Machinery Directive 89/392/EEC. The EC Low Voltage Directive 72/23/EEC and the EC EMC Directive 89/336/EEC.

- A 230V -50Hz mains electrical supply is required fused externally at 6,3A.
- A deviation on the grid of 230V (+10% or -15%) and 50Hz

The installation must continue to comply with:

United Kingdom:

- the national rules for electrical installations , IEE regulations.

Ireland:

- the ECTI national rules for electrical installations

The following additional regulations also apply:

- The boiler's wiring is not allowed to be changed;
- All connections have to be made to the terminal block.

The boiler has 4 terminals for all electrical connections.

1. High voltage supply (230V)
2. Voltage free switches (230V relays)
3. Low voltage sensors
4. Communication bus for cascaded Upsilon boilers

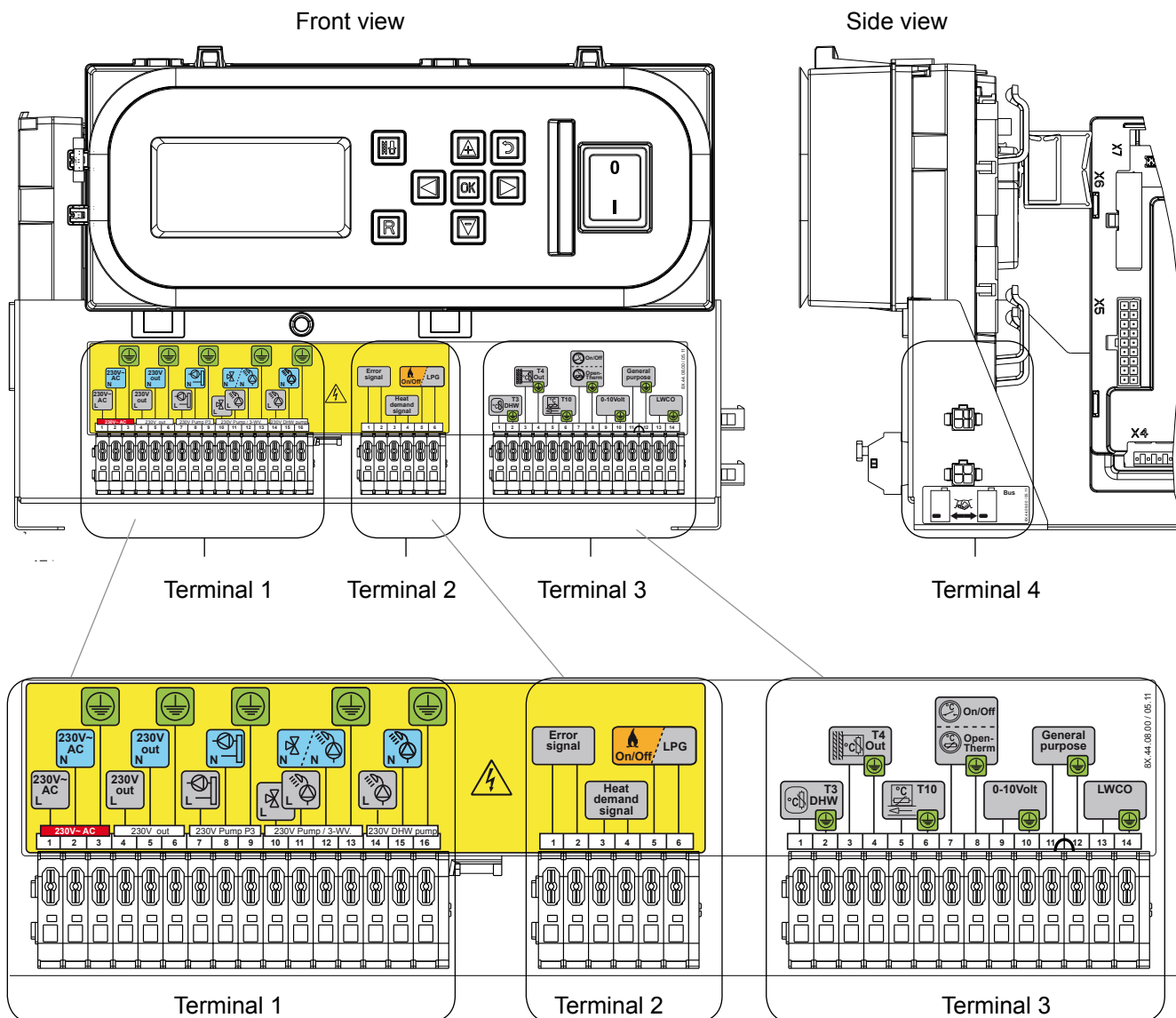

figure 7.a

1. High voltage supply: 16 Connections

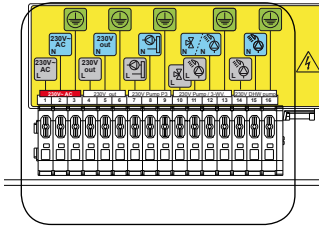

figure 8.b

Position	Connection			Application	PG	Max. V/A
1, 2, 3	Live	Neutral	Earth	Power for boiler. Power cable not supplied	13,5*	230V
4, 5, 6	Live	Neutral	Earth	Output	13,5	230V 4A
7, 8, 9	Live	Neutral	Earth	System pump P3	13,5	
10	Live			Three-way valve to CH	13,5	
11	Live			Three-way valve to DHW or DHW pump P2		
12		Neutral		Three-way valve or DHW pump P2		
13			Earth	Three-way valve or DHW pump P2	13,5	
14	Live			DHW load pump P4		
15		Neutral		DHW load pump P4		
16			Earth	DHW load pump P4		

2. High voltage switches: 6 Connections

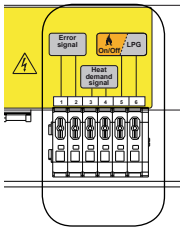

figure 8.c

Position	Connection		Application	PG	Max. V/A
1, 2	1	2	Relay output fault signal	13,5	230V 5A
3, 4	3	4	Relay output heat demand	13,5	230V 5A
5, 6	5	6	Relay output external heat source / 2nd propane gas valve	13,5	230V 5A

3. Low voltage sensors: 16 Connections

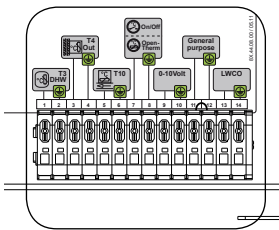

figure 8.d

Position	Connection		Application	Tulles
1, 2	1	2	Hot water sensor T3	IP67
3, 4	3	4	Outdoor sensor T4 (advice) n.a. at 0-10V	IP67
5, 6	5	6	Common flow sensor T10** (must be connected)	IP67
7, 8	7	8	On-Off contact / Open Therm contact (auto detect)	IP67
9, 10	9	10	0 -10 Volt input (temperature or load)	IP67
11, 12	11	12	Blocking contact (bridge mounted)	IP67
13, 14	13	14	Low water pressure switch off contact NO (function not active)	IP67

* PG glands for cable duct already assembled in the factory. For a few connections, some PG glands are supplied separately.

The maximum cable diameter for the terminals is 2.5mm²
Connect the cable by pushing down the control on the terminal strip using a flat screwdriver (refer to fig. 8.e).

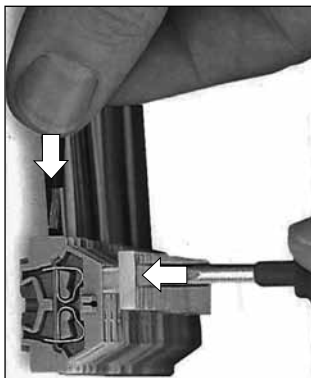

figure 8.e

4. Bus communication: 4-pole connector

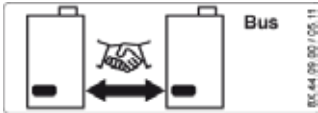

figure 8.f

Position	Connection	Application	PG
		Bus communication cable	IP67

The 0310289 bus communication cable mutually connects the cascaded boilers by 4-pole connectors on the side of the connection terminals (2 boilers: 1 cable, 3 boilers: 2 cables etc.) and is fitted with 2 IP67 tulle. A maximum of 8 boilers can be connected to the system.

8.1 External controls



NOTE:

- T10 must be connected
- T4 is advised to connect.

The Upsilon boiler provides in many possibilities to operate the boilers from external controls.



Only 1 type of control can be connected. Connections of the external control must be done in the master boiler (address 01) on terminal 3 and appropriate connections.

Below you will find a description of the possibilities and parameter adjustments to take account of.

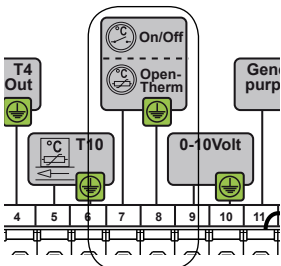

Figure 8.1.a

1. On-Off contact

An On-Off contact is a volt-free switch to create a heat demand with closed contact.

The On-Off control must be connected to terminal 3, position 7 and 8. This is also the connection for an OpenTherm-control, but it is self-detecting. No specific adjustments are necessary. See chapter 9.4 to adjust the flow temperature.

2. OpenTherm-control

An OpenTherm-control is a digital controller which is communicating with the boiler according the OpenTherm-protocol. The controller calculates continuously the desired flow water temperature and sends this to the boiler(s).

The OpenTherm-control must be connected to terminal 3, position 7 and 8. This is also the connection for an On-Off contact, but it is self-detecting.

After connecting an OpenTherm-control P230 will be visible (Setting level, Param. Chapter, Cascade Param.) where the maximum setpoint CH can be adjusted.

For control option 1 and 2 counts that the boiler controls its own output (modulating) to achieve the desired temperature. When this is achieved the boiler modulates back to maintain the desired temperature and prevents over shoot.

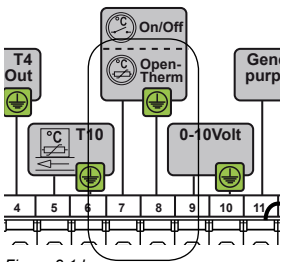

Figure 8.1.b



If an OpenTherm controller is used, it must be ensured that for certain error messages the heat demand is not omitted. This can result in complete loss of heat production.

OpenTherm error messages

The coding of the transmitted Error Messages on a OpenTherm controller is displayed as follows:

(E) EB (E = Error Code = B and boiler number)

example: Error Code Ex02SC02 on boiler 6 will appear as (0) 26

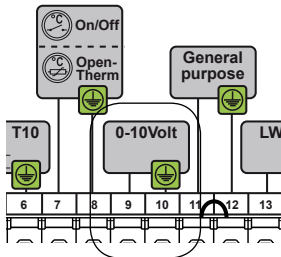

Figure 8.1.c

3. 0-10 Volt-control

At a heat demand of the 0-10 Volt controller a signal is sent out and varies from 0-10 Volt. This signal is translated by the Upsilon boiler to a set value (desired flow water temperature or load) which is sent via the data bus to the boiler(s). Depending on the Voltage the set value becomes higher or lower.

The 0-10 Volt-controller must be connected to terminal 3, position 9 and 10.

The choice for temperature or load control can be done by a parameter setting.

Go to Setting level and Param. Chapter, than to Cascade Param. and select P101.

When P101 is adjusted to 1 the **load control** is set. On that moment P205 until P210 in chapter Cascade Param. is released and can be adjusted according to specific requests. When P101 is adjusted to 2 the **temperature control** is set. On that moment P215 until P220 in chapter Cascade Param. is released and can be adjusted according to specific requests.

See chapter 11 for the adjustment possibilities.

ADVICE: Choose for temperature control for a more balanced boiler control

Behaviour of connected external controls

- When using an OpenTherm or 0-10Volt control and a clock program is selected, the clock program of the Upsilon will be ignored.
- When an on/off control is connected and the thermostat is switched on manually before the pre-setted switch-on time, the clock program will be ignored and will run on the set day temperature. When switching off manually the clock program will be followed.

8.2 Wiring diagram

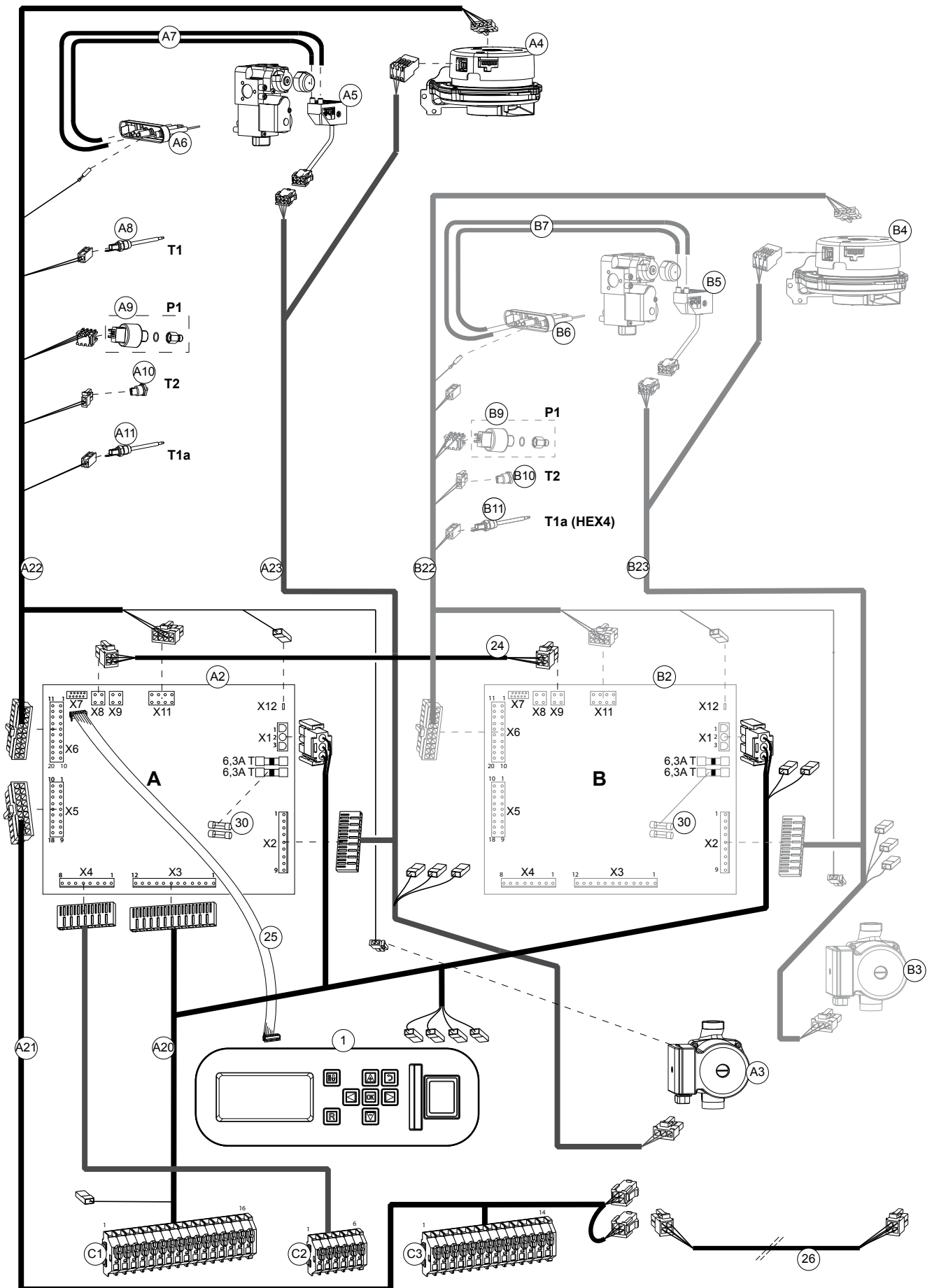

figure 8.1.a

Connections		
Item	Art.nr.	Description
Main components		
1		Control unit with screen
Burner A		
A2		Control unit
A3		Circulation pump
A4		Fan
A5		Ignition unit on gas block
A6		Ignition electrode
A7		Ignition cables
A8		Flow sensor T1
A9		Water pressure sensor P1
A10		Return sensor T2
A11		Flow sensor T1a
Burner B		
B2		Control unit
B3		Circulation pump
B4		Fan
B5		Ignition unit on gas block
B6		Ignition electrode
B7		Ignition cables
B8		Flow sensor T1
B9		Water pressure sensor P1
B10		Return sensor T2
B11		Flow sensor T1a (only HEX4)

Item	Art.nr.	Description	Conn.	Conn.	Cont.
0310356(S) Cable loom XL complete					
A20		Cable loom conn.terminal 230V+VF	Conn. C1		
				1 Main switch L	
				2 Main switch N	
				3 Earth	
				4 X1-A en X1-B, X4, 3, 1, L'	
				5 X1-A en X1-B, 2, N'	
				6 Earth "leeg"	
				7 C1 3, 9	
				8 X4 2	
				9 Main switch N'	
				10 C1 6, 13	
				11 X3 8	
				12 X3 6	
				13 X3 7	
				14 C1 9, 16	
				15 X3 2	
				16 X3 1	
				17 C1 13	
				18 X1-A en X1-B, Earth 1	
			Conn. C2		
				1 X4 3	
				2 X4 4	
				3 X4 5	
				4 X4 6	
				5 X4 7	
				6 X4 8	
A21		Cable loom conn.terminal LV	Conn. C3		
				1 X5 1	
				2 C3 4	
				3 X5 2	
				4 C3 2, 6	
				5 X5 5	
				6 C3 4, 8	
				7 X5 12	
				8 C3 6, 10	
				9 X5 16	
				10 C3 8, 12	
				11 X5 11	
				12 C3 10, 14	
				13 X5 14	
				14 C3 12	
				15 X5 15	
			X5		
				1 C3 1	
				2 C3 3	
				5 C3 5	
				8 Bus1 1	
				9 Bus1 2	
				11 C3 11	
				12 C3 7	
				14 C3 13	
				15 C3 14	
				16 C3 9	
				17 Bus1 3	
				18 Bus1 4	

Item	Art.nr.	Description	Conn.	Conn.	Cont.
A22		Cable loom LV burner A	X6		
				1 T1 1	
				2 T2 1	
				3 T1a 1	
				5 P1 1	
				6 P1 3	
				7 Fan pwm 4	
				8 Fan pwm 2	
				9 X6 19	
				11 T1 2	
				12 T2 2	
				13 T1a 2	
				15 P1 2	
				17 Fan pwm 5	
				18 Fan pwm 1	
				19 X6 9	
			X11		
				3 Pump pwm 1	
				7 Pump pwm 2	
			X12		
				Ionisation	
B22		Cable loom LV burner B	See A22		
A23		Cable loom 230V burner A	X2		
				1 Fan 230V 3	
				2 Fan 230V 2	Earth
				3 Fan 230V 1	
				4 Ignition and Gasvalve 1	
				4 Ignition and Gasvalve 4	
				2 Ignition and Gasvalve 2	Earth
				3 Pump 230V 3	Earth
				5 Pump 230V 2	
				6 Pump 230V 1	
				7 Ignition and Gasvalve 3	
				8 Ignition and Gasvalve 6	
B23		Cable loom 230V burner B	See A23		
24		Cable loom bus Burner A-B	X8-A	X8-B	
				1 X9 1	
				2 X9 2	
				3 X9 3	
				4 X9 4	
25 0310383(S) Flat cable MMI					
26 0310289 Communication bus cable Upsilon					

9 Boiler control

The boiler has a control unit. This control takes care of most of the manual settings but also provides numerous settings to adjust the control exactly to the installation and user requirements.

Display

The LCD screen is backlit. The light is activated by pushing one of the buttons.







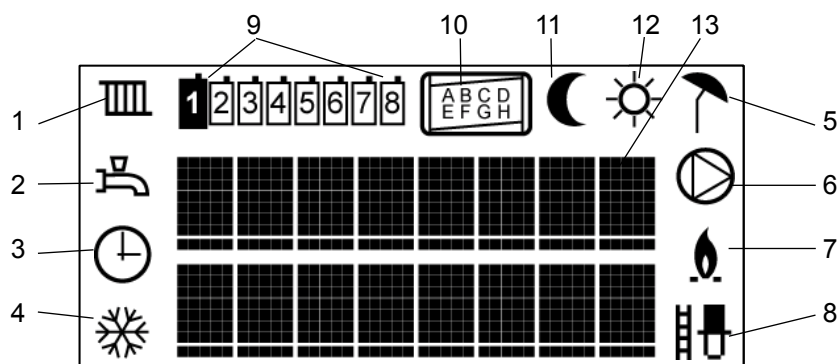

There are 3 light colours available. The various colours indicate the following:

Blue	Basic level
Green	Setting level
Red	Problem display (flashing)

Having pressed a button, the screen light stays on for 2 minutes (blue screen) or 20 minutes (green screen).

Screen explanation



-  1. CH-program active
-  2. DHW-program active
-  3. Clock program active
-  4. Pump continuously active or pumps active when frost protection is active
-  5. Boiler off at outside temperature > T-day (when day temperature is active)
or > T-night (when night temperature is active)
-  6. System pump on
-  7. Burner on. Starts flashing during ignition, continuous when burner is on
-  8. Chimney sweep function (100% power for emission measurement)

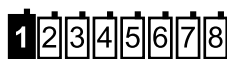

- 9. Boiler address:
1 = Cascade Master
2.8 = Cascade Slaves



- 10. Identification burner inside boiler



- 11. Night temperature active



- 12. Day temperature active

- 13. 2 text lines with 8 characters each

Boiler symbols are not visible in case of a single boiler or when no bus communication cable is connected (Message code M024sc08).

9.1 Operational status

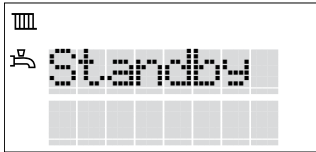

- Standby	Standby. Boiler is ready for operation.
- Vent.Phase	Ventilation stage
- Ignition phase	Ignition stage
- Burner lit CH	Burner active for heating
- Burner lit DHW	Burner active for hot water
- CH T > Tset	Burner off on account of too high flow temperature CH
- Overrun CH	Overrun time pump over CH
- Overrun DHW	Overrun time pump over DHW
- Service	Boiler needs maintenance. Contact installer
- Frost	Burner active for frost protection

9.2 Operation

The keyboard consists of a logical key allocation for menu control, confirmation, and correction and emission measurement.

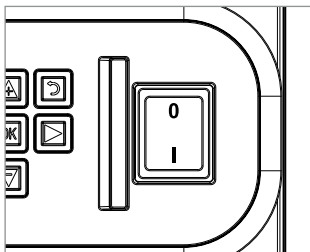
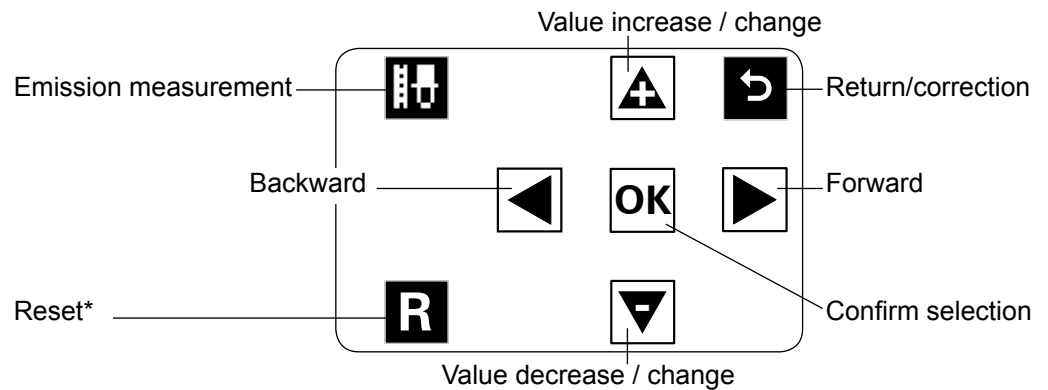

* Reset only functions in case of an Error or Message. If reset is rapidly pressed over a short period of time, the device will block completely. Only loss of power (power switch) will restart the device completely. Recommendation: First identify the fault by finding the fault code in the fault-code list in the problem-shooting chapter and solve the problem.

The main switch is located on the right hand side of the keyboard. This switch controls the 230V power supply (L and N).

9.3 Commissioning

Turn the electrical supply on (heating system does not have to be filled);

During start-up, a blue screen is displayed:

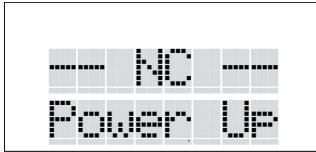

NC Power Up (= start-up screen)

Please wait (under certain circumstances)

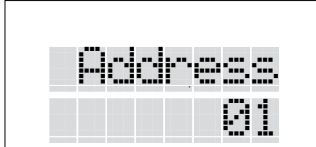

Then you see: Address 01 (= allocation of boiler address)



In the case of a cascade installation: Select the correct address and press OK

Select for the first boiler 01 (=Master), for the next 02, 03 etc (=Slave)

The address can be changed by pushing the + button (increase value) and the – button (decrease value). Once the + or – buttons has been pushed, the value starts flashing.

In the case of a single boiler: Confirm address 01 by OK

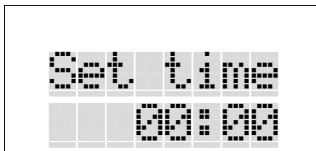

The display shows: Time Set 00:00 (= setting actual time)

Setting time and day is only required on the Master-boiler. The Slave-boiler will take the time and day settings automatically.

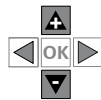

First set the hours using + and -.

Press the "right arrow" button to move to the minutes.

Set the minutes using + and -.

Confirm by OK

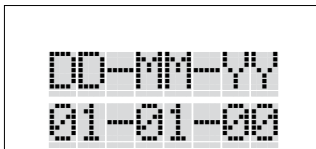

The display shows: DD-MM-YY 01-01-00 (= setting actual date)

Change the settings using the + and – button. Jump from DD to MM and YY using the arrow button.

After confirmation by OK and after the automatic de-aeration programm has ended, you will see the standard read-out "Good" showing the date and the time after the de-aerating program.

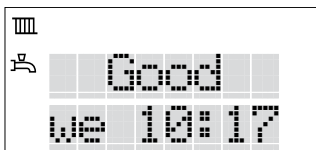

Standard read-out: Good we 10:17

Good indicates that the boiler operates normally (burner on or off)

wo 10:17 indicates the actual day and time.

Following a restart (after loss of power):

Following a brief loss of power, the control will start-up as described above, but all settings are retained.

In the case of a loss of power lasting more than 2 hours the time and date has to be setted again. All other settings are retained.

If the water pressure is below 1.0 bar, the screen will show: FILL. Please refer to the chapter Filling CH-system.

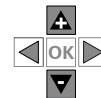

The standard read-out offers 3 information screens.

Switching to different screen scan can be found using the + or - button

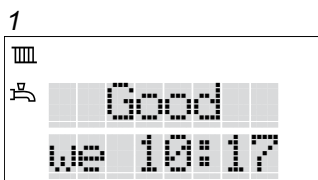

1. "Good"- read-out Good with actual day and time (see above)

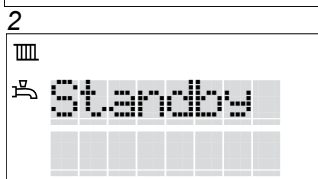

2. Operational status Refer to chapter 9.1 for explanation of texts

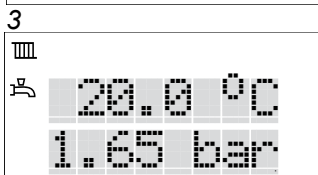

3. Technical read-out Actual water flow temperature. (T1 in °C) and water pressure (P in bar).

For Upsilon boilers in cascade

For Upsilon boilers in cascade, the bus communication cables between the boilers must be connected (see section electrical connections).

The master-boiler (address 01) should be set to how many boilers are actually connected.

From the standard display with illuminated display (blue):

1. Press 2 seconds the arrow keys simultaneously (green display);
2. Use the right arrow button until: Param Mode;
3. Press the OK button; *Cascade param. is shown*;
4. Press the OK button again;
5. Push the right arrow key until P114;
6. Press the OK button;
7. Press the + key until the total number of boilers in cascade;
8. Press the OK button;
9. Press the return key until standard read-out

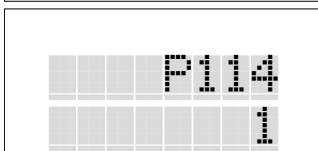
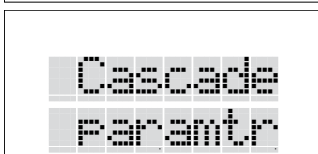
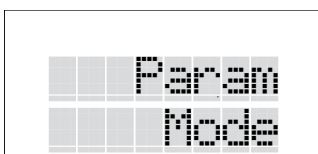

Switching on the Heating, DHW and Pump program

By switching on the functions (, and/or) the boiler is turned on.

Proceed as follows:

From the standard display with illuminated display:

1. Press the right arrow button:
The display shows: Basic settings;
2. Press the OK button;
3. Press the right arrow button:
The display shows: CH prog off;
4. Press the + button:
The display shows: CH prog on;
5. Press the OK button;
6. Repeat the procedure from point 3.
In this way the functions DHW and Pump can be switched on.
7. Press the return button to go back to the standard display.

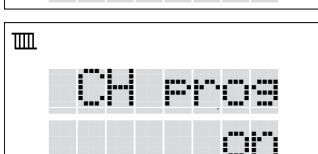
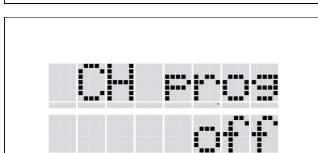
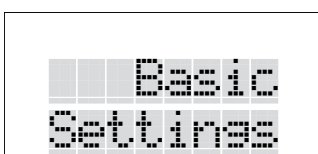

Depending from the programs that are switched on the corresponding symbols will be shown.

9.4 Setting the maximum flow water temperature with On/Off-control

P101 = 0

Setting the maximum flow water temperature with connected outdoor sensor T4 (starting with illuminated display):

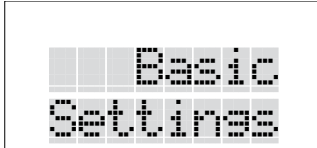

1. Press the right arrow button:
The display shows: Basic Settings;

2. Press the OK button;

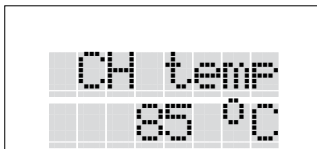

3. Press the right arrow button until CH temp:
The display shows: CH temp 85°C;

4. Press the + or - button to adjust the desired flow temperature and press the OK button.

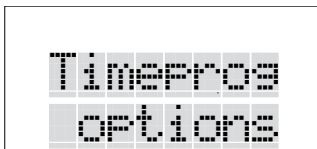

Setting the maximum flow water temperature without outdoor sensor T4 (starting with illuminated display):

1. Press the right arrow button until Timeprog-options;

2. Press the OK button;

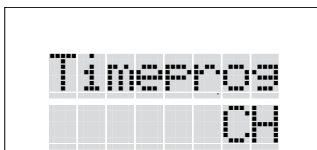

3. Press the right arrow button until Timeprog CH;

4. Press the OK button;

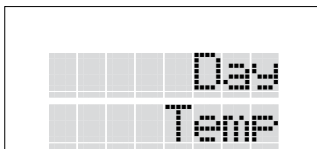

5. Press the right arrow button until Day Temp;

6. Press the OK button;
The display shows: T_day

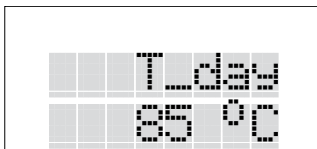

7. Press the + or - button to adjust the desired flow temperature and press the OK button.

9.5 Filling the heating system

When all boilers have been electrically commissioned as described above, then the heating system can be filled. Each boiler is fitted with a filling and drain valve. The filling hose from the water tap is then connected to it.



Fill the heating system only with drinking water. Refer to the Water Quality chapter for quality requirements of the filling water.

Water pressure

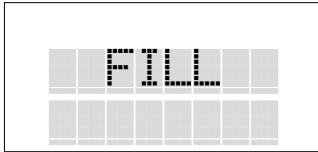
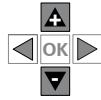

Screen display			Description	Action
Good Read-out	Operation status	Technical read-out		
FILLdd 00:00	FILL Bx12sc03	xx.x°C P0,0	Water pressure is 0 bar, boiler off	Top up water
FILL dd 00:00	FILL Bx12sc03	xx.x°C P≥0,7	Water pressure above 0.7 bar. The boiler is off. The automatic venting program starts	Top up water until approx. 1,7 bar
Block. dd 00:00	Vent Prog.	xx.x°C P≥1,2	Automatic venting program, afterwards (approx. 13 min.) boiler is on standby	Top up water until approx. 1,7 bar
Good dd 00:00	(variable)	xx.x°C P>1,0 <4,0	Water pressure is good. Boiler standby or in normal operation	None
Block. dd 00:00		xx.x°C P≥4,0	Water pressure too high, boiler off due to blocking	Drain water until approx. 1,7 bar
Good dd 00:00	(variable)	xx.x°C P<3,7	Water pressure is good. Boiler operates normally again	None
Message/ Block. dd 00:00	FILL Message Mx24sc14	xx.x°C P<1 >0,7	Water pressure too low. Boiler is limited to 50% load	Top up water until approx. 1,7 bar

Venting program

When, on filling the system, the water pressure rises above 0.7 bar, the venting program will start automatically. The program lasts approx. 13 minutes and in doing so, turns the pump on and off and, if fitted, the three-way valve every 80 seconds to remove the remaining air from the boiler. All venting points still have to be vented when filling the installation. The boiler will be on standby after the venting program.



The automatic venting program only vents the boiler and not the rest of the installation.

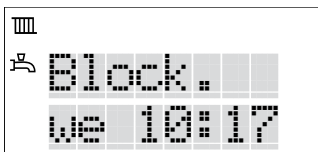

Read-out 1 (Good status) displays Block. with actual day and time on the screen.

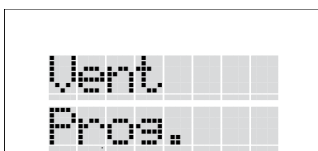

Read-out 2 (operational status) displays Vent Prog on the screen. [From Good press the – button 1x: Vent Prog is now displayed]

Interrupting the venting program (not recommended) is only possible from the setting level by pressing OK during the venting program.

For boiler checks please refer to the chapter Checks prior to commissioning. For any checks or setting changes, refer to the Basic Settings chapter.

10 Basic settings

Menu structure

There are 2 setting levels

1. Basic level (manager/user) Blue screen
2. Setting level (Installer): Green screen



With the illumination switched off, first press on one of the buttons to switch the illumination on and then continue with the setting. Having pressed the last button, the blue illumination will switch off after 2 min.

Menu structure at Basic level

Good				
Operational status	Basic setting	Timeprog. options	Param Mode	Info
Tech. Read-out	OK	OK	OK	OK
▶ CH prog	▶ Set Date and time	▶ Boiler param	▶ Cascade	
▶ DHW prog	▶ Timeprog. CH	▶	▶ Other	
▶ Pump prg.	▶ Timepr. DHW			
▶ Timepr. CH		▶		
▶ Timepr. DHW				
▶ CH temp				
▶ DHW temp				
▶ Units				
▶ Language				
▶ Restore Defaults				
		▶		

◀▶ With the arrow buttons you can go through the different chapters.

OK Press OK to select or to confirm a change.

▲ ▼ With the + and - button you can increase or decrease a selected value.

◀▶ Back to previous screen or standard read out. Press this 'return-button'.

Remark: Depending which parameter settings are set, some options will not be displayed.

Refer to the Parameters chapter for all parameters and related settings.

Clock program (from standard switched off in Basic settings)

The switch times in the pre-set clockprograms are detailed in the table on the right. Each clock program can be adjusted to each individual situation. Conditions are:

- Maximum 4 switch points per day;
- Settings for day and night are determined by the settings: Time pr. options/Time prog. CH/Day Temp. and Night temp.;
- The setting OFF switches the heating off during the whole set period. The frost protection is active;
- Setting - - - turns the switch point OFF;
- Switch times can be set in steps of 30 minutes.

Advice:

Keep in mind when setting the switching periods for domestic hot water that it is sufficiently long to ensure that hot water is always available during actual use. In most cases, the pre-set program 1 of the clock program suffices.

Behaviour of connected external controls

- When using an OpenTherm or 0-10Volt control and a clock program is selected, the clock program of the Upsilon will be ignored.
- When an on/off control is connected and the thermostat is switched on manually before the pre-setted switch-on time, the clock programm will be ignored and will run on the set day temperature. When switching off manually the clock program will be followed.

Pre-set clock programs							
Day	Switch point	CH pre-set 1		CH pre-set 2		DHW pre-set 1*	
		Time	Setting	Time	Setting	Time	Setting
<small>4 switch points per day, adjustable per 30 min.</small>							
mo	1	7:00	day	8:00	day	3:00	on
	2	18:00	night	12:00	night		
	3			17:00	day		
	4			19:00	night		
tu	1	7:00	day	8:00	day		
	2	18:00	night	12:00	night		
	3			17:00	day		
	4			19:00	night		
we	1	7:00	day	8:00	day		
	2	18:00	night	12:00	night		
	3			17:00	day		
	4			19:00	night		
th	1	7:00	day	8:00	day		
	2	18:00	night	12:00	night		
	3			17:00	day		
	4			22:00	night		
fr	1	7:00	day	8:00	day		
	2	18:00	night	12:00	night		
	3			17:00	day		
	4			19:00	night		
sa	1			8:00	day		
	2			12:00	night		
	3			17:00	day		
	4			19:00	night		
su	1						
	2						
	3						
	4						

* The clock program for domestic hot water is set on continuous demand to prevent there being no hot water available at starting up. The program can be adjusted to each individual situation.

Menu structure at Setting level

With the illumination switched off, first press on one of the buttons to switch the illumination on and then continue with the setting. Having pressed the last button, the green illumination will switch off after 2 min.

From the standard read-out, keep both arrow buttons pushed down simultaneously for 2 sec. The screen colour will change from blue to green.

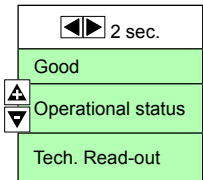
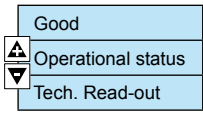

◀▶ With the arrow buttons you can go through the different chapters.
 OK Press OK to select or to confirm a change.
 ▲▼ With the + and - button you can increase or decrease a selected value.
 ↶ Back to previous screen or standard read out: Press this 'return-button'.

	Basic setting	Timeprog. options	Param Mode	Service Mode	Error	Info
	OK	OK	OK	OK	OK	OK
▶ CH prog	▶ Set Date and time	▶ Cascade param	▶ Throttle	▶ Error Burner A	▶ Cascade	
▶ DHW prog	▶ Timeprog. CH	▶ Boiler param	▶ Airflush	OK	▶ Boiler	
▶ Pump prg	▶ Timeprog. DHW	▶ Burner A Param	▶ Pump speed	▶ Error 01	▶ Burners	
▶ Timepr. CH	↶	▶ Burner B Param	▶ 3-way valve	▶ Error 02	▶ Other	
▶ Timepr. DHW		↶	▶ Pump P2	▶ ...		↶
▶ CH temp			▶ Pump P3	▶ Error 10		
▶ DHW temp			▶ Pump P4	▶ Error Burner B		
▶ Units			▶ LPG	↶		
▶ Language			▶ Fault			
▶ Restore Defaults			▶ Heat demand			
↶			▶ Boiler address			
			▶ Reset Counters			
			↶			

Remark: Depending which parameter settings are set, some options will not be displayed.

Refer to the Parameters chapter for all parameters and related settings.

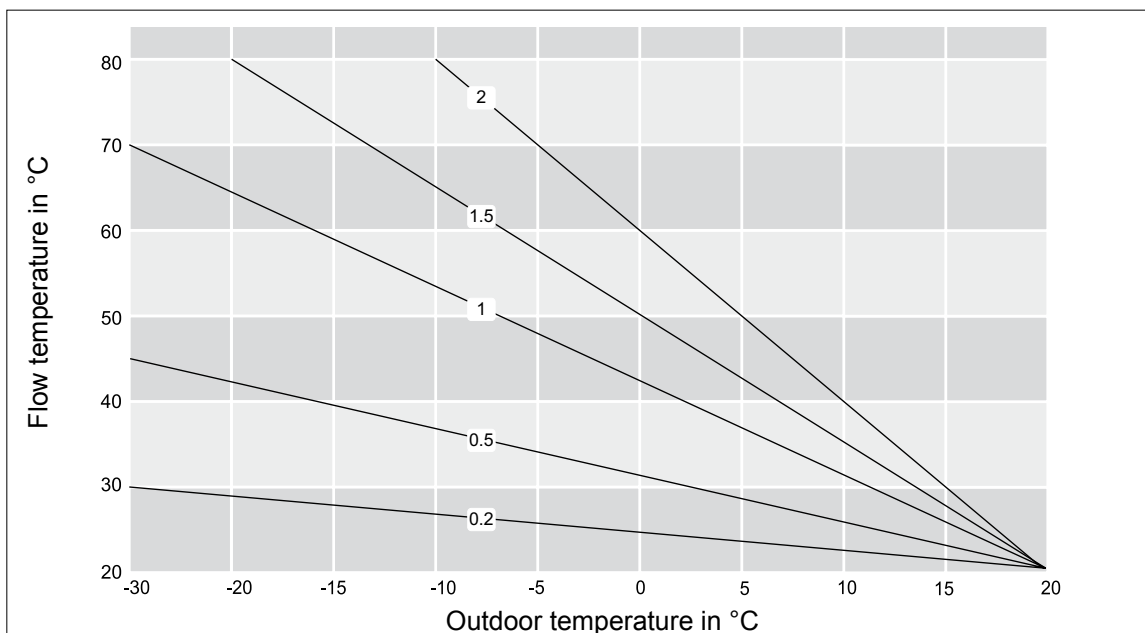

Heating line (K-factor)

Grafic 11.a

11 Parameters

For operation and menu overview, refer to chapter Boiler control and Basic settings.

Basic settings		Basic settings	
PARA	factory setting	Description	Range
CH prog	off	CH-program	on/off
DHW prog	off	DHW-program	on/off
Pump prg	off	Pump program (frost protection)	on/off
Timerpr CH	off	Clock program CH	on/off
Timerp DHW	off	Clock program DHW	on/off
CH temp	90	Adjusted maximum flow temperature in °C (only active with connected outdoor sensor & P101=0)	10-90
DHW temp	65	Adjusted maximum DHW temperature in °C (only visible when DHW is activated)	10-80
Units	SI	Selection possibility units SI=Europe, Imp(erial)= USA	SI/Imp
Language	GB	Language selection	GB, NL, I, D, F, PL, TR, DK, E
Restore defaults		Reset of the factory settings (dependant of selected level)	

Timeprog options		Clock program options	
PARA	factory setting	Description	Range
Set date and time			
Set Time	00:00	Actual time setting in hours and minutes	
Set Date	DD-MM-YY	Actual date setting day-month-year	
Daylight saving	Europe	Zone for daylight saving	Off-Eur-USA
	12/24hrs	0-24h	12-hour (AM/PM) or 24-hour display
Date format	DD-MM-YY	Reproduction of date display (DD-MM-YY, MM-DD-YY, YY-MM-DD)	AM/PM-24h.
Time prog CH (only visible when NOT OpenTherm or 0-10V)			
Day temp	T-day 20	Day temperature according heating line in °C (if outdoor sensor is NOT connected: max flow temp.)	10-30 (10-90)
Night temp	T-night 15	Night temperature according heating line (Eco) in °C	10-30
Select Preset	Preset 1	Choice for the preselected time programm CH	1 or 2
Adjust Timeprog	mo1 off 03:00	See table time programs CH It is possible to select 4 switch moments (steps of 30 min.) per day. Choice: day temperature, night temperature, off, - - - Copy function to next day: after switch moment 4.	
Store Preset		Store of the adjusted time program for CH	
Timepr DHW (only visible when NOT OpenTherm)			
Select Preset	Preset 1	Choice for the preselected time programm DHW	1 or 2
Adjust Timeprog	mo1 off 03:00	See table time programs DHW It is possible to select 4 switch moments (steps of 30 min.) per day. Choice: on, off, - - - Copy function to next day: after switch moment 4.	
Store Preset		Store of the adjusted time program for DW	

Param Mode	Parameter chapter			
PARA	factory setting	Description		Range
Cascade param.		Cascade parameters		
P100	0	Domestic hot water facility 0: no DHW 1: Solo boiler with 3-way valve 2: n.a. 3: Solo boiler with cylinder loading pump P4 and 3-way valve 4: n.a. 5: After low loss header: DHW after LLH with cylinder pump P2 and P3=off 6: After low loss header: DHW after LLH with cylinder pump P2 and P3=on at heat demand CH 7: After low loss header: DHW loading system after LLH with cylinder loading pump P2, P4 and P3=off 8: After low loss header: DHW loading system after LLH with cylinder loading pump P2, P4 and P3=on at heat demand CH	NOTE: Option 6 and 8 not for Low Temperature systems, unless separately controlled	0-8
P101	0	Heating 0: 0+10V not active 1: 0+10V= load control (see further P205 until 210) 2: 0+10V= temperature control (see further P215 until 220) 3: Showroom position	ADVICE for using 0-10V: Choose option 2 for a balanced behaviour of boiler control.	0-3
P104	0	Outside sensor T4 0: autodetect 1: connected		0-1
P105	0	Common flow sensor T10 0: autodetect 1: connected		0-1
P106	30	Min. Setpoint T10		0-60
P107	0	Min.Setpoint function T10 0: off 1: minimum value setpoint at heat demand CH 2: continuously minimum value setpoint		0-2
P109	0	Correction outside sensor		-5 - 5
P111	20	CH-set gradient-reference		0-60
P112	1,0	CH-set gradient in °C/10sec in steps of 0,1°C		0-10
P114	1	Number of boilers in cascade (To be set manually!)		1-8
P121	1	Relay function Propane/External heating source 0: Only propane 1: On/Off external heating source		0-1
P125	1	DHW priority 0:No 1: Yes		0-1
P157	0	OpenTherm error bit selection 0: Only errors 1: Errors and blockings 2: Errors, blockings and messages		0-2
P158	0	Error relay selection 0: Only errors 1: Errors and blockings 2: Errors, blockings and messages		0-2
P170	90	Switch on moment relay external heating source When demand is higher then adjusted value the external heating source will be switched on		0-100%
P171	85	Switch off moment relay external heating source When demand is lower then adjusted value the external heating source will be switched off		0-100%
P203	2	Overrun time secondary pump P3 in minutes At P101 = 1 (Load control):		0-60
P205	2	0-10V, load voltage to have minimum heat demand (P208 power) (If P101=1)		0-10
P206	9,5	0-10V, load voltage to have maximum heat demand (P207 power) (If P101=1)		0-10
P207	100%	0-10V, load maximum power (dynamic range) (If P101=1)		0-100
P208	0%	0-10V, load maximum power (dynamic range; 0% is minimum power) (If P101=1)		0-100
P209	1	0-10V, load heat demand when input voltage> (If P101=1)		0-5
P210	0,5	0-10V, load no heat demand when input voltage< (If P101=1)		0-5
		At P101 = 2 (Temperature control):		
P215	2	0-10V, load voltage to have minimum heat demand (If P101=2)		0-10
P216	9,5	0-10V, load voltage to have maximum heat demand (If P101=2)		0-10
P217	1	0-10V, load heat demand when input voltage> (If P101=2)		0-5
P218	0,5	0-10V, load no heat demand when input voltage< (If P101=2)		0-5
P219	30	0-10V, temperature setpoint at minimum input voltage (If P101=2)		10-90
P220	85	0-10V, temperature setpoint at maximum input voltage (If P101=2)		10-90
P252	2	Slope heating line (K-factor)		0,1 - 9,9
P256	2	Hysteresis Summer/Winter in °C (if T4 was detected)		0-10
P266	2	Switch on delay at heat demand in minutes		0-10
P267	168	Boiler sequence for boilers in cascade in hours		1-255
P283	1	Frost protection 0: T10 and P3 not active 1: T10 and P3 active		0-1
P284	-5	Switch on temperature frost protection in °C		-40 - 20

Boiler param		Boiler parameters	
P100	0	Domestic hot water facility (visible when boiler address is 2 - 8) 0: no DHW 1: Solo boiler with 3-way valve 2: n.a. 3: Solo boiler with cylinder loading pump P4 and 3-way valve 4: n.a.	0-4
P102	0	Cascade flue gas system 0: Flue gas system individual or collective under pressure 1: N.a. 2: Flue gas system collective over pressure 3 N.a.	0-3
P108	0	Kind of gas 0: natural gas 1: propane gas	0-1
P122	0	DHW temperature sensor T3 0: autodetect 1: connected	0-1
P123	30	Switching time 3-way valve in seconds	0-255
P125	1	DHW priority 0: No 1: Yes	0-1
P132	1	Pump continuously 1: Unit pump P1 2 Unit pump P1 and installation pump P3	1-2
P154	100%	Maximum load CH	0-100
P155	100%	Maximum load DHW	0-100
P160	100%	Maximum pump capacity (only with modulating circulation pump)	30-100
P179	1	Overrun time cylinder pump P2/P4 in minutes (if P100 > 1)	0-60
P181	5	Minimum cool down DHW temperature in °C (if P100 > 0)	0-15
P182	1	Load adjustment due to temperature fall DHW in °C/10sec. (if P100 > 0)	0-10
P183	65	DHW Anti legionella temperature (if P100<>0 and P122=1) in °C	10-80
P184	7	DHW Anti legionella service timer (if P100<>0 and P122=1) in days	1-30
P185	3:00	DHW Anti legionella time of day (if P100<>0 and P122=1)	0:00-23:50
P190	80	Flow temperature T10 at DHW in °C (using cylinder thermostat) (if P100 > 0)	10-90
P801	0%	Local altitude compensation and flue length	0-15%

BurnerA param		Burner A parameters	
		When the boiler has 2 heat exchangers Burner B will follow with the same parameters	
P953	HEX4: 65% HEX2: 80%	Minimum pwm-level pump (only with modulating pump).	43-100%

Service chapt.		Service chapters	
		Choose burner AB, A or B after selecting one of the functions using arrow buttons. Exchanger symbol will show: AB, A or B	AB-A-B
Throttle	0	Manually burner control. Press OK, then + and - button to increase/decrease the value (0=off, 1%=low load untill 100%=full load)	0-100
Airflush	0	Manually fan control Press OK, then + and - button to increase/decrease the value	0-100
Pumpspeed.	43	Minimum pump speed (only with modulating circulation pump)	43-100%
3-way valve / P2	CH	Manually control of the 3-way valve for DHW. Only for boilers with DHW via 3-way valve	CH-DHW (at P2: on-off)
Pump P3	off	Manually control of the system pump P3. (Only when pump is off) When 'On' pump symbol will be displayed	on-off
Pump P4	off	Manually control of the DHW pump P4	on-off
LPG	off	Manually control of LPG valve (Volt-free)	on-off
Fault	off	Manually control of fault relay for external error signal (Volt-free)	on-off
Heat demand	off	Manually control of heat demand relay for external display heat demand (Volt-free)	on-off
Boiler on-off	off	Manually control of external heating source. On-off contact for control external heating source (not visible in case of LPG)	on-off
Boiler address		Adjusting/changing boiler address	01-08
Reset Counters		Reset of counters after maintenance interval	

Error	Errors	A-B
Error burner A	The last 10 errors with data will be stored. Choose burner A or B using arrow buttons. Exchanger symbol will show: A or B	
Error 01	Select other error number (02-10) with arrow buttons Every error contains the following info (Press + button for forward, - button for backward)	
	Code Exxscxx	
	Date	
	Time	
	Operational status	
	T1 flow temperature	
	T2 return temperature	
	T1a secondary flow temperature	
	P1 water pressure	
	P2 cylinder pump	
	P3 system pump	
	P4 cylinder load pump	
	Damper on/off (no function)	
	Fan on/off	
	Gas valve open/closed	
	Ignition on/off	

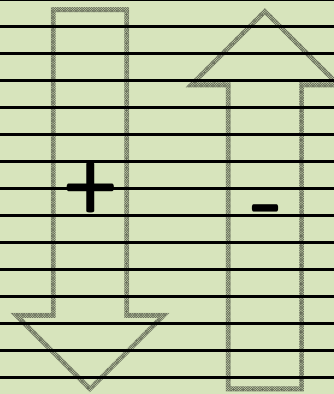

Info	Information		
Cascade	Information of cascade system		
T3	xx.x°C	DHW temperature T3 in external cylinder in °C (if connected and P100 is selected for DHW)	
T4	xx.x°C	Outdoor temperature T4 in °C (if connected)	
T10	xx.x°C	Temperature T10 sensor in low velocity header in °C	
OT sp	x.x°C	OpenTherm setpoint room temperature in °C (visible when OT is selected)	
Req Load	xx%	Requested load of the cascade system in %	
Req Temp	xx.x°C	Actual requested flow temperature according gradient line of the cascade system in °C	
Req Temp	xx.x°C	End value of the requested flow temperature of the cascade system in °C	
Error	off	Status relay external error signal	on-off
P3	off	Status system pump P3	on-off
P4	off	Status cylinder loading pump P4	on-off
Heatdmd.	off	Heat demand yes/no	on-off
LPG / Extra B	off	Status relay external heating source	on-off

Boiler	Information of the boiler		
T1-ave	xx.x°C	Actual average flow temperature of the boiler in °C	
T2-ave	xx.x°C	Actual average return temperature of the boiler in °C	
T3	xx.x°C	DHW temperature T3 in external cylinder in °C (if connected and P100 is selected for DHW)	
Req Load	xx%	Requested load of the boiler in %	
Req Temp	xx.x°C	Requester flow temperature of the boiler in °C	
3WV	closed	Status 3-way valve	open-closed
P2	off	Status DHW pump P2	on-off
P4	off	Status cylinder loading pump P4	on-off

BurnerA	Information of burner/heat exchanger A		A-B
	Select burner A or burner B using + and - button. Symbol heat exchanger will show: A or B		
T1	xx.x°C	Actual flow temperature	
T1a	xx.x°C	Actual flow temperature secondary sensor	
T2	xx.x°C	Actual return temperature	
Req Load	xx%	Requested load in %	
Flame	x.xx uA	Actual ionisation in µA	
Water Pr	x.xx bar	Actual water pressure	
FanSpeed	xx	Actual fan speed in revolutions per minute	
Fan PWM	x.x%	Actual fan capacity in %	
Fan	off	Status fan	on-off
Gas	off	Status gas valve	on-off
Ign.	off	Status ignition	on-off
P1 PWM	x.x%	Actual pump speed in % (only with modulating circulation pump)	
P1	off	Status pump	on-off

Others	Select burner A or burner B using + and - button. Symbol heat exchanger will show: A or B		A-B
Stand-by	xx h	Number of hours stand by	
Burn ON	xx h	Number of running hours with burner on	
Service	xx h	Number of running hours to go for maintenance interval	
Ignition	xx	Number of times ignition	
Faults	xx	Number of times in error	
Safety	02017005		
Regul.	01017016		
MMI	03017017		
OEM par.	00017xxx	xxx: 020 = UB70, 080 = UB110, 140 = UB140	

11.1 Activate factory settings

Do the following to reactivate factory settings (any changed settings will be lost):

Activating the factory settings from user level only:

From the standard blue screen display:

1. Select using the right arrow button: Basic settings;
2. Press the OK button;
3. Press the right arrow button until: Restore Defaults
4. Press OK
Screen displays: Restore OK
5. Press OK again
Screen displays: Restore Defaults
This has now restored the factory settings.

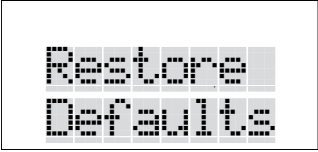

Restore
Defaults



Confirm
Restore



Activating the factory settings from installer level:

From the standard blue screen display:

1. Press down the arrow buttons simultaneously for 2 seconds;
2. Continue with the same instructions from point 1 to 5 described above.

The procedure can take about 20 seconds and shows a blank screen followed by the text Please Wait.

12 Put out of operation

In some cases it might be necessary to put the complete boiler out of operation. The boiler is put out of operation by switching off the three functions ( ,  and/or ).

Proceed as follows:

From the standard blue screen display:

1. Press the right arrow button:
Screen displays: Basic setting;
2. Press OK;
Screen displays: CH prog on;
3. Press the - button:
Screen displays: CH prog off;
4. Press OK;
5. Repeat procedure from point 3 onward.
This switches off the functions DHW prog and Pump prog respectively.
6. Press the return button to return to the standard display.

A.O.Smith recommends leaving the power switch switched on to ensure that the boiler pump(s) and three-way valve (if fitted) are automatically activated to prevent them from sticking. The frost protection remains active. Leave gas valve open.



If frost, during the period when the boiler is out of operation, is likely, then you are advised to remove the power from the boiler and drain the boiler(s) and installation. In this case: close also the gas valve.

13 Inspection and maintenance



Boiler maintenance is only to be carried out by qualified staff with calibrated equipment.
When replacing spare parts only original A.O.Smith Service parts are to be used.
Please contact A.O. Smith.

13.1 Maintenance intervals

Maintenance has to be carried out after 16,000 operational hours max. or every 4 years, whatever comes first.

Depending on the intensive use of the device, maintenance intervals will have to be decreased accordingly. For other situations, maintenance intervals may also have to be decreased. In such cases, please contact A.O.Smith for additional advice.

Inspection and maintenance tasks have to be carried out in accordance with the maintenance instructions at all times. Some tasks are described in these maintenance instructions. For complete inspection and maintenance instructions, please contact A.O. Smith.



When carrying out maintenance on the boiler, the gas tap has to be closed and secured against opening.

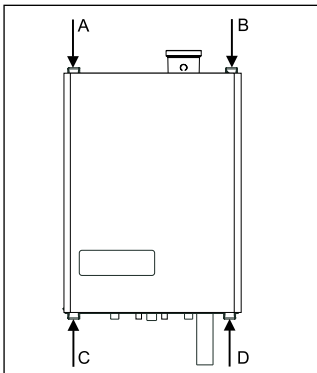

Removing housing

figure 13.1.a

The housing has to be removed in order to carry out maintenance jobs on the boiler. The housing has been secured by 4 quick-lock nuts. First, remove the screws from the quick-locks, open the quick-locks, lift up the housing from below and move it away to the front.

13.2 Checks prior to commissioning

Changing settings such as burner pressure and setting the amount of air is not necessary. Only in the case of failures or replacement of the gas unit, venturi and/or ventilator, does one have to check and adjust the zero-pressure control and O₂ percentage accordingly (Refer to Help reference).



Following maintenance tasks always check all gas-conducting components on leakages by use of leakage detection spray.

13.2.1 Emission check



In order to be able to check on the boiler's emission during its years of operation, it is recommended to measure the maximum air displacement of the boiler on commissioning. This value may be different for each boiler type.

This measuring is only worthwhile if the value is known on commissioning.

The following tasks have to be carried out to enable measuring this value:

- Press down the arrow buttons simultaneously for 2 seconds.
The screen turns green;
- Press the right arrow button until you see Service chapter.;
- Press OK;
- Press the right arrow button until Airflush is displayed;
- Press OK;
The screen displays Airflush off;

Only for UB 110 and UB 140:

- Press the right arrow button to select burner A.
The exchanger symbol displays the selected burner (AB, A or B)
- Open the top test nipple (fig. 13.2.1.a);
- Connect the hose of the digital pressure meter to the top test nipple of the gas unit

OUT: 0-pressure adjustment
MIN: Gas pressure

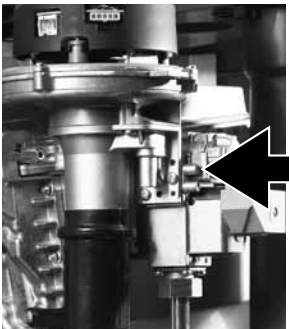

Measuring point air flow figure 13.2.1.a



Measuring is only allowed using the top test nipple (refer to arrow).

- Press on the + button until the maximum value (100%).
The ventilator will start running up to its max. revolutions per minute RPM (burner stays on)
- Measure the under-pressure and record the value.
During the next boiler check, the under-pressure value may have decreased by 20% max. compared to the value on commissioning. If this value has decreased less than 20% the boiler does not require any maintenance.
- Press the – button until *off* is displayed (keep pushed down)

This ends the procedure for burner A.

Only for UB 110 and UB 140:

- Press the return button 1x
- Press the right arrow button to select burner B.
The exchanger symbol displays the selected burner (AB, A or B)

Repeat the procedure for burner B.

- Press the return button to return to the original read-out.

13.2.2 Check O₂



The O₂ percentage is set by the factory. It has to be checked during inspection, maintenance and faults.

It can be checked as follows:

- Ensure that the boiler is at maximum load and can dump the heat generated;
- Press down the arrow buttons simultaneously for 2 seconds.
The screen turns green;
- Press the right arrow button until you see Service chapter.;
- Press OK;
The screen displays Throttle;
- Press OK;
The screen displays Throttle off;

Only for UB 110 and UB 140:

- Press the right arrow button to select burner A.
The exchanger symbol displays the selected burner (AB, A or B)
- Calibrate the O₂ meter ;
- Position the lance of the O₂ meter into the flue outlet test point (refer to fig. 13.2.2.a);
- Press on the + button until the maximum value (in kW) has been reached;
The boiler will be burning at the rated full capacity (value on display in %)
- Leave measuring O₂ to the measuring equipment.

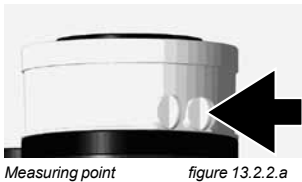

Measuring point figure 13.2.2.a

- **O₂ percentage at full load =**
 - **CO₂ percentage at full load =**
- | | Natural gas | Propane |
|--|---------------------|----------------------|
| | 4,7% (-1,2%, +0,8%) | 5,1% (-1,2%, +0,7%) |
| | 9,0% (-0,4%, +0,6%) | 10,3% (-0,4%, +0,8%) |
- If required, you may turn the setting screw to set the correct O₂ percentage.
(refer to fig. 13.2.2.b).

Finally, the O₂ percentage at low load must be checked:

- Press on the - button until the value 1 has been reached.
The boiler will be burning at low capacity (value on display in %).
- Leave measuring O₂ to the measuring equipment and check if the measured O₂ percentage on low load is between following values:

- **O₂ percentage at low load between**
 - **CO₂ percentage at low load between**
- | | Natural gas | Propane |
|--|--------------------|----------------|
| | 5,0% and 7,0% | 5,1% and 7,0% |
| | 7,7% and 8,8% | 9,1% and 10,3% |

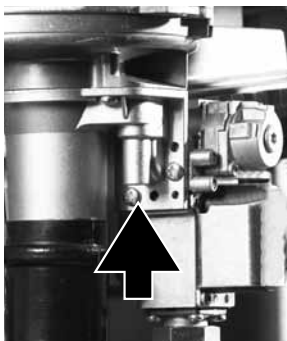

adjusting screw figure 13.2.2.b

Contact A.O. Smith when the measured values is outside this range.

End of measuring:

- Press the – button until *off* is displayed (keep pushed down).

This ends the procedure for burner A.

Only for UB 110 and UB 140:

- Press the return button 1x
- Press the right arrow button to select burner B.
The exchanger symbol displays the selected burner (AB, A or B)

Repeat the procedure for burner B.

- Press the return button to return to the original read-out.

13.3 Maintenance activities

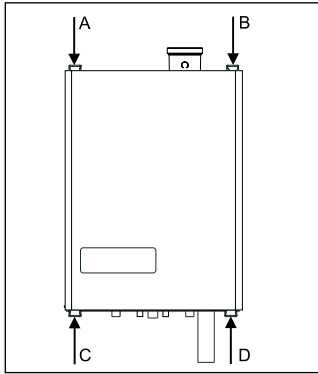

Removing housing

figure 13.3.a

The following actions have to be taken in order to be able to carry out maintenance:

- Switch the device off using the mains switch,
- close the gas tap;

Refer to figure 13.3.a:

- Unscrew the 4 screws of quick-locks A, B, C and D
- Open the 4 quick-locks A, B, C and D and remove the housing (= air box) from the front.

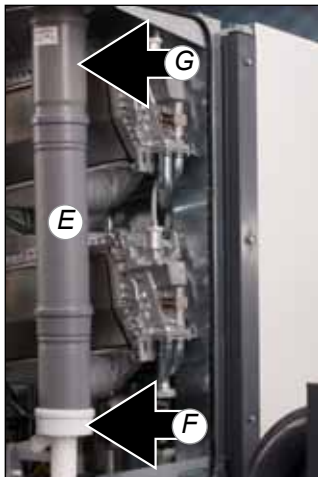

Removing flue pipe

figure 13.3.b

Dismantle the internal flue gas pipe as follows (refer to fig. 13.3.b):

- Unplug the flue gas sensor if fitted;
- Press the 2 clips of the siphon adapter (F) and push that part of the flue gas vent pipe (E) down. Leave the siphon adapter (F) hanging on the bottom plate
- Slide the slider (G) in the upper part of the flue gas pipe upward.
- Pull the flue gas pipe (E) forward (both exchangers simultaneously).

Ventilation unit and burner cassette (refer to fig. 13.3.c and d)

- Remove the plug connections of the gas valve (1) and ventilator (2);
- Unscrew the coupling (3) of the gas unit;
- Replace the gas valve gasket with a new one;
- Unscrew the front cross-slotted screw (4) of the air suction damper (5);
- Loosen the left (9) and right (10) clamp bar a quarter of a turn and pull it out in a forward direction. In doing so, pay attention to the turning direction (red check cams);
- Pull the complete ventilator unit and heat exchanger's gas valve forward;

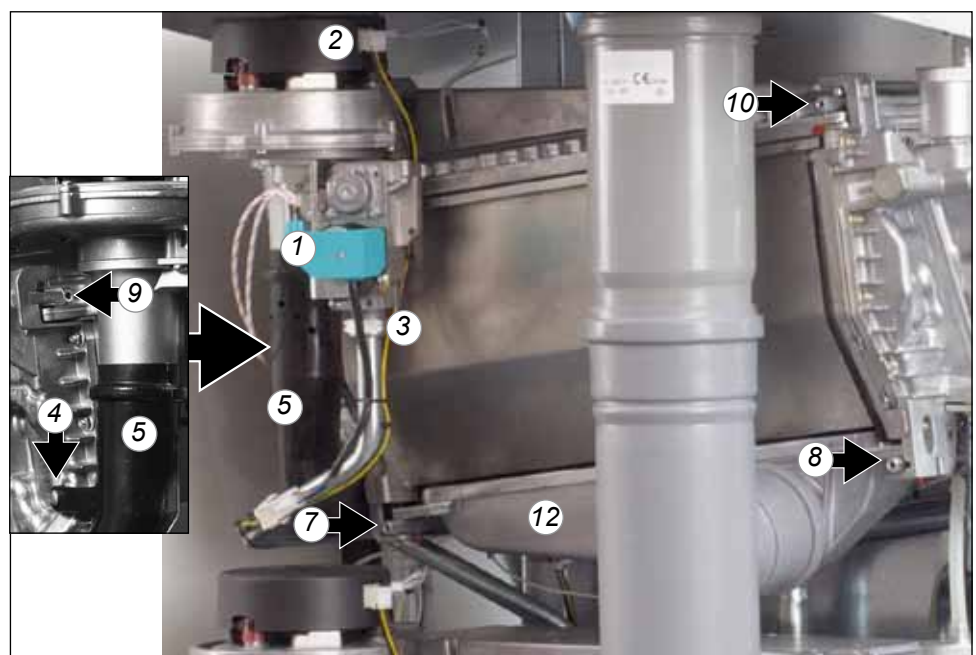

figure 13.3.c

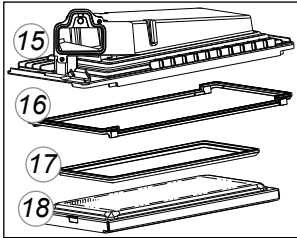
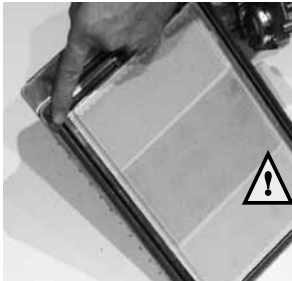

figure 13.3.d

- Remove the burner cassette (18) from the ventilator unit;
- Check the burner cassette for wear and tear, pollution and any breakages. Clean the burner cassette with a soft brush and vacuum cleaner. In the case of breakages, always replace the complete burner cassette (18);
- Replace the gasket (17) between the burner (18) and upper casing (15) ;
- Replace the gasket (16) between the upper casing (15) and exchanger:



Position gasket

figure 13.3.e

Checking the non return valve in the upper casing, venturi and fan

1. Loosen with a 8mm wrench the top bolt of the fan flange
2. Unscrew the bottom bolt completely from the fan flange using a 8mm socket / crank wrench
3. Remove the fan with gas valve from the upper casing and replace the black seal in the upper casing by a new one.
4. **The following operations must be performed carefully in relation to the vulnerability of the non return valve.**
Remove the non return valve completely from the upper casing. Check the non return valve if the entire circumference closes / seals completely. If the valve seals fully, replace the non return valve back into the upper casing (transparent part inside). Replace the non return valve if the valve does not seal properly.

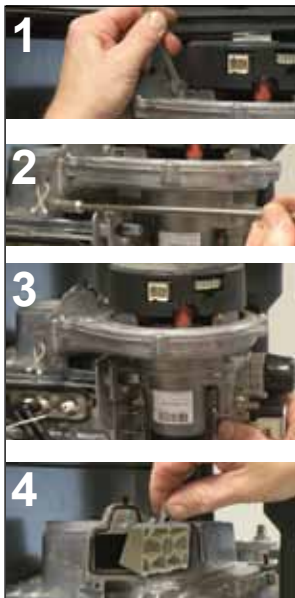

Checking non return valve

figure 13.3.f

- Check the venturi and gas distribution plate for pollution and clean them, if necessary, with a soft brush and a vacuum cleaner. If the header is extremely dusty, then it is likely that the fan is also dirty. To clean it, the ventilator has to be dismantled from the upper casing and the venturi. Clean the fan with a soft brush and vacuum cleaner. At the same time, replace the gasket and ensure that the new gasket is properly fitted when installing the ventilator parts.

Heat exchanger

- Check the heat exchanger for pollution. Clean it, if necessary, with a soft brush and vacuum cleaner. Prevent any dirt from dropping down.
Rinsing the exchanger with water from the top is not allowed.

Assembly is done in reverse order.

Ensure during assembly that the clamping bars are properly positioned. They have to be in a vertical position.

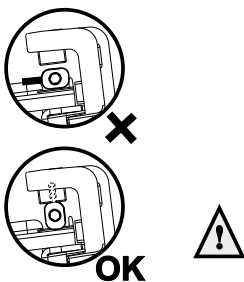

figure 13.3.g

Ignition electrode

Replace the ignition electrode when necessary, but certainly every 4 years.

This can be checked by reading out the ionisation current. The minimum ionisation current has to be greater than 2,0 μA at full capacity.

To read out the ionisation current follow the instructions:

From the standard blue screen display:

1. Press down the arrow buttons simultaneously for 2 seconds;
2. Continue with point 3.

From the setting level with a green screen:

3. Select using the right arrow button: Info;
4. Press the OK button;
5. Press the right arrow button until: Burners
6. Press the OK button;
7. Press the right arrow button until: Flame.

The ionisation current is shown here in μA . With the + and - button the value of burner A and B can be shown (heat exchanger symbol turns from A to B).

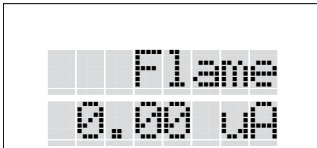

If the sight glass is damaged, the complete ignition electrode has to be replaced.

Replace as follows:

- Remove the plug connections of ignition electrode;
- Push the clips on either side of the electrode to the outside and remove the electrode;
- Remove and replace the gasket;

Assembly is done in reverse order.

Condensate container (refer to fig. 13.3.c and e)



Take precautions to prevent condensate falling on electronics and other boiler parts during dismantling to avoid damage of these parts.

- Remove the short clamping bars (7 and 8) by loosening them a quarter of a turn. In doing so, pay attention to the turning direction (red check cams).
- Pull the clamping bars forward and away from underneath the condensate container.
- Carefully push the condensate container (12) down and remove it from the front;
- Replace the condensate container gasket by a new one.
- Clean the polluted condensate container with water and a hard brush.
- Check the condensate container for any leakages.

Assembly is done in reverse order.

Ensure proper all around sealing of the gasket when installing the condensate container.

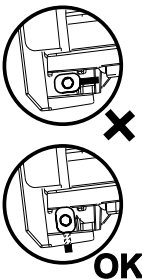

figure 13.3.h



Ensure during assembly that the clamping bars are properly positioned. They have to be in a vertical position.



During maintenance always replace the gaskets of dismantled parts.

Syphon (refer to fig. 13.3.f)



Place a collector (i.e. a bucket) under the syphon to collect the dirty and aggressive condensate water. Wear protective clothing like latex gloves and safety glasses.

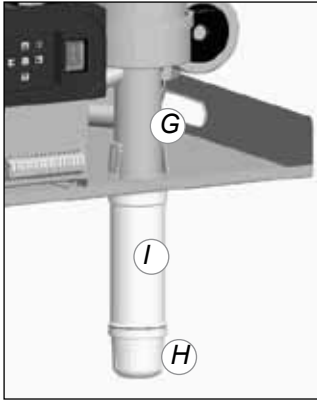

Syphon

figure 13.3.e

- Dismantle the syphon by unscrewing the syphon cup (H).
Check the syphon cup (H), syphon adapter (G) and syphon pipe (I) for pollution.
- Clean these parts by rinsing them with water.
- Re-grease the O-rings with acid-free O-ring grease to facilitate easy assembly.
- If the syphon shows any leakage, the whole syphon has to be replaced:

Take the device back into operation and conduct a flue gas analysis (refer to chapter Check O₂).

13.4 Counter running hours

From factory a fixed number of running hours is set for service interval. The number of running hours can not be changed. After expiring of the number of running hours the message "Service" is displayed on the screen.

If the maintenance activities, as described hereinbefore, have been carried out, the counter has to be reset.

To reset the counter, the following procedure has to be followed (starting from a blue screen):

- Press down the arrow buttons simultaneously for 2 seconds.
The screen turns green;

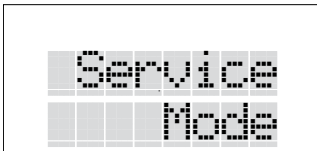

- Press the right arrow button until you see Service chapter.;

- Press OK;

- Press the right arrow button until you see Reset Counters;

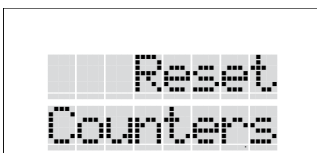

- Press OK;

The screen displays Confirm Reset;

- Press OK to confirm the reset function;

The screen displays Confirm Reset;

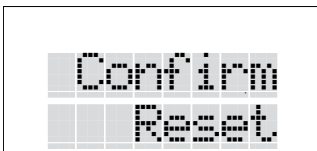

The counter is reset to the same number of hours as set from factory. The message "SERVICE" is no longer displayed.

14 Error report

On the display, errors found are shown in the form of a message or blocking on a blue screen or an error on a red screen.

- Blocking *This is a temporary error that will sort itself out, or it will block the boiler after several attempts (error)(Except: Bx01sc01 = reset)*
- Error *Error implies a blocking of the boiler and can only be solved by a reset and/or intervention of a service engineer.*
- Message *Implies a message such as low water pressure, but the device will remain operational.
Point of attention requiring short-term intervention.*

OpenTherm error messages

The coding of the transmitted Error Messages on a OpenTherm controller is displayed as follows:

(E) EB (E = Error Code = B and boiler number)
example: Error Code Ex02SC02 on boiler 6 will appear as (0) 26

The code consists of a Main Code and a Subcode

Main code Blocking = B
Main code Error = E
Main code Message = M
Followed by a character 0 = boiler
1 = burner A
2 = burner B

Subcode always starts with sc



Block.
B000sc00

Bx01sc01 Fan does not run on correct speed (Reset necessary). Fan defective.
Bx03sc01* Flow sensor T1 open
Bx03sc02* Flow temperature T1 too high
Bx03sc03* Flow sensor T1a open
Bx03sc04* Flow temperature T1a too high
Bx05sc01* Return sensor T2 open
Bx05sc02* Return temperature T2 too high
Bx08sc01* General purpose contact open
Bx12sc01* Water pressure sensor open
Bx12sc02* Water pressure sensor closed
Bx12sc03* Water pressure lower than 0.7bar. Top up
Bx12sc04* Water pressure too high. Decrease pressure
Bx12sc05* No pressure increase on pump start
Bx13sc01* ΔT between T1 and T2 too high
Bx15sc01* Communication error between controls



Error
E000sc00

Ex01sc01* Fan does not run on correct speed. Fan defective.
Ex02sc01* No flame after 4 start attempts
Ex02sc02* Insufficient ionisation
Ex04sc01* Flow temperature T1 too high
Ex04sc02* Flow sensor T1 closed
Ex04sc03* Flow temperature T1a too high
Ex04sc04* Flow sensor T1a closed
Ex06sc01* Return temperature T2 too high
Ex06sc02* Return sensor T2 closed
Ex18sc01* Unwanted flame forming
Ex14sc01* ΔT not fast enough
Ex14sc02* ΔT between T1 and T2 > 35°C



Message
M000sc00

M024sc01 DHW sensor T3 open (when P122=1)
M024sc02 DHW sensor T3 closed (when P122=1)
M024sc03 Outside sensor T4 open
M024sc04 Outside sensor T4 closed
M024sc05 Common flow sensor T10 open
M024sc06 Common flow sensor T10 closed
M024sc08 Bus communication: Possibly no bus communication cable connected
Mx24sc09 Temperature increase (Gradient) not fast enough after burner start
Mx24sc10 ΔT between T1 and T2 > 35°C when gas valve opened

* When this code is shown with an M instead of a B or E then a reset with the reset button is possible.

15 Warranty conditions

To register your warranty, visit the website www.aosmithinternational.com/content/product-registration and fill in the Product Registration Form. Registering the boiler gives the owner of the boiler supplied by A.O. Smith Water Heaters the right to the warranty set out below, which defines the commitments of A.O. Smith Water Heaters to the owner.

15.1 General warranty

If within 2½ (two and a half) years after the original production date of a central heating boiler supplied by A.O. Smith Water Heaters, following verification, and at the sole discretion of A.O. Smith Water Heaters, an assembly or part (with exclusion of the heat exchanger) proves to be defective or fails to function correctly due to manufacturing and/or material defects, then A.O. Smith Water Heaters shall repair or replace this assembly or part.

15.2 Heat exchanger warranty

If within 5½ (five and a half) years after the original production date of a central heating boiler supplied by A.O. Smith Water Heaters, following verification, and at the sole discretion of A.O. Smith Water Heaters, the stainless steel heat exchanger proves to be leaking due to rust or corrosion occurring on the water side, then A.O. Smith Water Heaters shall offer to replace the defective heat exchanger with an entirely new heat exchanger. The warranty period given on the replacement heat exchanger shall be equal to the remaining warranty period of the original central heating boiler that was supplied.

15.3 Conditions for installation and use

The warranty set out in articles 1 and 2 will apply solely under the following conditions:

- a. The central heating boiler is installed under strict adherence to A.O. Smith Water Heaters installation instructions for the specific model, and the relevant government and local authority installation and building codes, rules and regulations in force at the time of installation.
- b. The central heating boiler is exposed to regular use. Regular use means that the central heating boiler is used for room heating installation and/or production of sanitary hot water, for which the number of burning hours is not exceeding 4000 hours per year. These are installations where the flow temperature is not exceeding 90°C.
- c. The central heating boiler remains installed at the original site of installation.
- d. The water used in the central heating boiler system complies with the specification as described in the installation instructions.
- e. The central heating boiler is safeguarded by means of periodic service and maintenance by an approved service engineer.
- f. The water pressure and/or heat load do not exceed the maximum values stated on the rating plate of the central heating boiler.
- g. The central heating boiler is installed in a non-corrosive atmosphere or environment.
- h. For a combi type central heating boiler (meant for both central heating and sanitary hot water) only drinking water may be used on the sanitary side. A.O. Smith Water Heaters is not responsible for damage to storage tank, plate heat exchanger or heat exchanger in case of use of water that does not comply with the drinking water guidelines with regard to hardness and chloride concentration.
- i. Replaceable user parts such as gaskets, seals, glass fuses, O-rings and ignition and flames sensing pens are excluded for warranty.

15.4 Exclusions

The warranty set out in articles 1 and 2 will not apply in the event of:

- a. damage to the central heating boiler caused by an external factor;
- b. misuse, neglect (including frost damage), modification, incorrect and/or unauthorized use of the central heating boiler and any attempt to repair leaks;
- c. non approved contaminants or other substances having been allowed to enter the heating system loop of the central heating boiler (see installation instructions);
- d. any attempts at repair to a defective central heating boiler other than by an approved service engineer.
- e. use of non original A.O. Smith Water Heaters parts for spare parts or as a repair part.

15.5 Scope of the warranty

The obligations of A.O. Smith Water Heaters pursuant to the specified warranty are limited to free delivery from the warehouse of the replacement assemblies, parts or central heating boiler, respectively. Shipping, labor, installation and any other costs associated with the replacement will not be accepted by A.O. Smith Water Heaters. Replaced parts can only be claimed at A.O. Smith Water Heaters if they are returned to A.O. Smith Water Heaters in its original service-/spare part packaging.

15.6 Claims

A claim on grounds of the specified warranty must be submitted to the dealer from whom the central heating boiler was purchased, or to another authorized dealer for A.O. Smith Water Products Company products. Inspection of the central heating boiler as referred to in articles 1 and 2 shall take place in one of the laboratories of A.O. Smith Water Heaters.

15.7 Obligations of A.O. Smith Water Heaters

A.O. Smith Water Heaters grants no other warranty or guarantee over its central heating boilers nor the (assemblies or parts of) central heating boilers supplied for replacement, other than the warranty expressly set out in these warranty conditions. Under the terms of the supplied warranty, A.O. Smith Water Heaters is not liable for damage to persons or property caused by (assemblies or parts of) a (replacement) central heating boiler that it has supplied.

Annex A Technical specifications

Technical specifications Natural gas G20

Boiler type	Upsilon			
	UB 70	UB 110	UB 140	
Type heat exchanger	HEX4	HEX4 HEX2	HEX4 HEX4	
Input Hs CH	kW	68,5	107,9	136,4
Qn Input Hi CH	kW	61,8	97,3	123
Efficiency class according BED		★★★★	★★★★	★★★★
Rendement volgens EN677 / EN15417 (36/30°C deellast, onderw.)	%	110,2	110,3	110,2
Efficiency according EN677 / EN15417 (36/30°C part load, Hi)	%	109,8	109,2	108,9
Efficiency according EN677 / EN15417 (80/60°C full load, Hi)	%	97,3	97,6	97,6
Modulation range CH (capacity 80/60°C)	kW	8,8 - 60,1	14,8 - 95,0	17,6 - 120,0
Modulation range CH (capacity 50/30°C)	kW	9,9 - 65,0	16,8 - 102,3	19,8 - 130,0
Flue gas pressure	Pa	175	195	195
Nox class EN483, EN15420		5	5	5
O ₂	%	4,7 (-1,2%, +0,8%)		
CO ₂	%	9 (-0,4%, +0,6%)		
Flue gas non-return valve present		yes	yes	yes
Flue gas temp. CH (80/60°C on full load)	°C	76	73	77
Flue gas temp. CH (50/30°C on low load)	°C	30	30	30
Gas consumption G20 CH (at 1013 mbar/15°C)	m ³ /h	6,53	10,29	13,01
Gas category		II2H3P		
Boiler flue category		B23 B33 C13 C33 C43 C53 C63 C83 C93		
Electr. power consumption max.	W	161	250	322
Electr. power consumption part load	W	44	86	88
Electr. power consumption stand by	W	2,5	3,7	3,7
Current	V/Hz	230/50	230/50	230/50
Degree of protection acc. EN 60529		IPX4D (IPX0D for B ₂₃ & B ₃₃)		
Weight (empty)	kg	65	83	87
Mounting weight	kg	54	72	76
Width	mm	660	660	660
Height	mm	1065	1065	1065
Depth	mm	460	460	460
Mounting height (excl. flue connection)	mm	1715	1715	1715
Water content CH	l	7	12	14
Overrun time pump CH	min	3	3	3
P _{MS} Water pressure min./max.	bar	0,7 / 4	0,7 / 4	0,7 / 4
Flow temperature max.	°C	85	85	85
Type pump Grundfoss UPM	HEX4	GEO 25-85	GEO 25-85	GEO 25-85
	HEX2	-	2 25-60	GEO 25-85
CE product identification number (PIN)		0063CM3648		

* EN15417 = Specific requirements for condensing boilers with a nominal heat input exceeding 70 kW up to 1000 kW

Technical specifications Propane gas G31

Boiler type	UB 70	UB 110	UB 140	
Type heat exchanger	HEX4	HEX4 HEX2	HEX4 HEX4	
O ₂	%	5,1% (-1,2%, +0,7%)		
CO ₂	%	10,3% (-0,4%, +0,8%)		
Restriction plate diameter	mm	5,7	5,7 (HEX4) 5,2 (HEX2)	5,7
Pre-pressure	mbar	see data plate propane		
Load(H _i)	kW	61,8	94,9	123
Gas consumption G31 (1015mbar, 15°C)	kg/h	4,80	7,37	9,54
	m ³ /h	2,52	3,87	5,01
Modulation range (80/60°C)	kW	19,5-60,1	35,1-95,0	39,0-120,0
Modulation range (50/30°C)	kW	22,0-65,0	39,7-102,3	44,0-130,0



NOTE:

The Upsilon boilers can be run on propane/lpg. The lpg-gas has to have a propane purity of at least 90%. When the butane-level is greater then 10% the warranty conditions on the heat exchangers are not valid.

Annex B System water additives

When the filling water requirements as referred to in chapter Water Quality have been met, certain additives are allowed for the below mentioned applications and related dosage. Warranty on A.O.Smith delivered installation products expires, if these additives and concentrations are not used in accordance with this annex.

Additive type	Supplier and specifications	Max. concentration	Application
Corrosion inhibitors	Sentinel X100 Corrosion resistant protection agent of CH systems Kiwa certified	1-2 l/100 litres CH water content	Aqueous solution of organic and inorganic agents preventing corrosion and scale forming
	Fernox F1 Protector Corrosion resistant protection agent of CH systems Kiwa certified KIWA-ATA K62581, Belgaqua certified Cat III	500 ml can or 265 ml Express / 100 litres CH water content	Preventing corrosion and scale forming
Anti-freeze	Kalsbeek Monopropyleneglycol / propane-1,2-diol + inhibitors AKWA-Colpro KIWA-ATA Nr. 2104/1	50% w/w	Anti-freeze
	Tyfocor L Monopropyleneglycol / propane-1,2-diol + inhibitors	50% w/w	Anti-freeze
	Sentinel X500 Monopropyleneglycol + inhibitors Kiwa certified	20-50% w/w	Anti-freeze
	Fernox Alphi 11 Monopropyleneglycol + inhibitors Kiwa certified KIWA-ATA K62581, Belgaqua certified Cat III	25-50% w/w	Anti-freeze in combination with F1 Protector
System cleaners	Sentinel X300 Solution of phosphate, organic heterocyclic compounds, polymers and organic bases Kiwa certified	1 litre / 100 litres	For new CH installations Removes oils/grease and flow control agents
	Sentinel X400 Solution of synthetic organic polymers	1-2 litres / 100 litres	For cleaning existing CH-installations Removes sediments.
	Sentinel X800 Jetflo Aqueous emulsion of dispersants, moistening agents and inhibitors	1-2 litres / 100 litres	For cleaning new and existing CH-installations Removes iron and lime-related sediments.

Annex C Dimensions

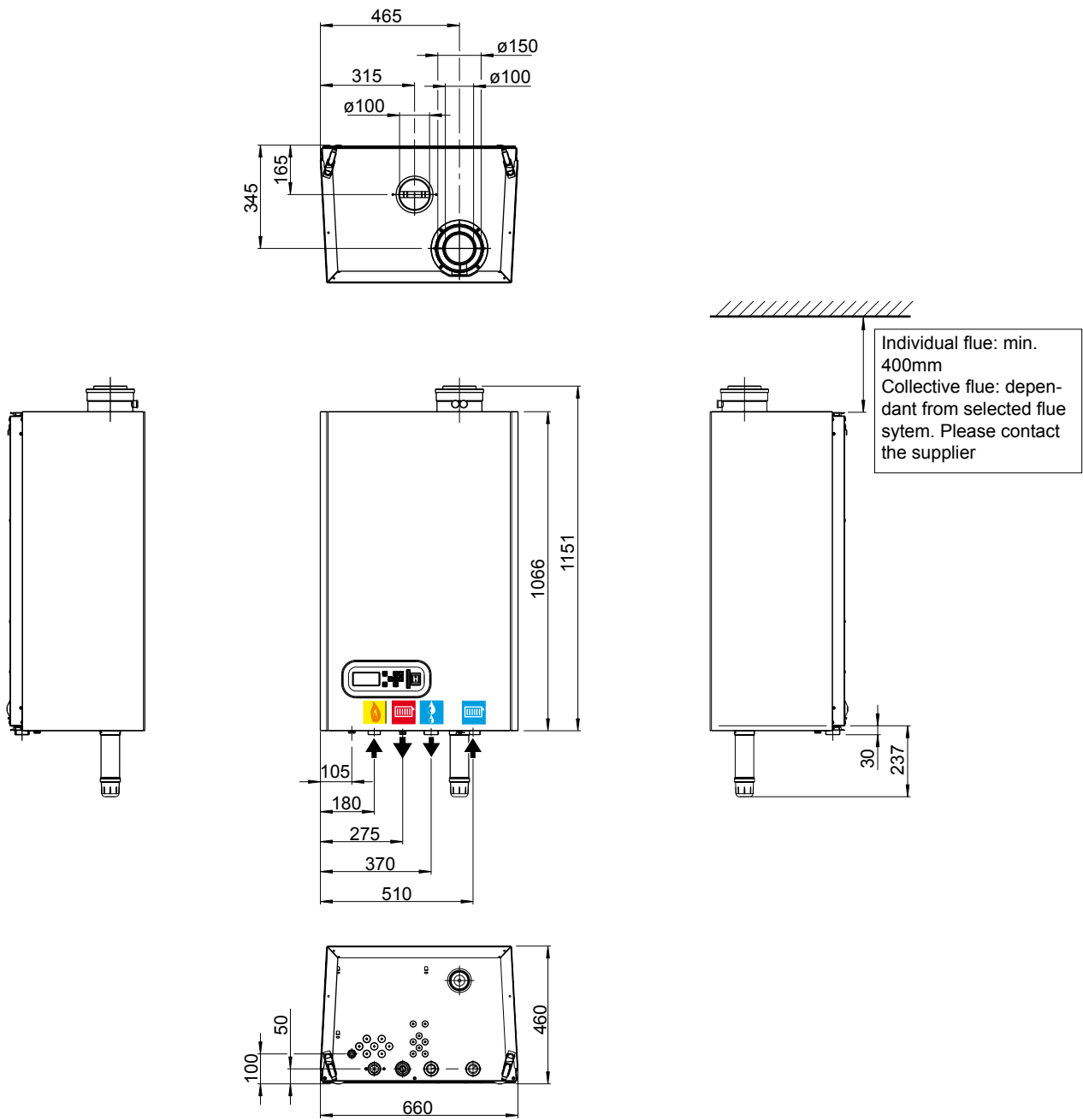





Boiler type		Upsilon		
		UB 70	UB 110	UB 140
Concentric flue system	mm	100 / 150	100 / 150	100 / 150
Parallel flue system	mm	2x 100	2x 100	2x 100
 Gas pipe - g		1 1/4"	1 1/4"	1 1/4"
 Flow pipe CH - a		1 1/2"	1 1/2"	1 1/2"
 Return pipe CH - r		1 1/2"	1 1/2"	1 1/2"
 Condensate drain pipe - c	mm	26	26	26

Table connection dimaeters

Table C.a

2 Upsilon boilers free-standing in line

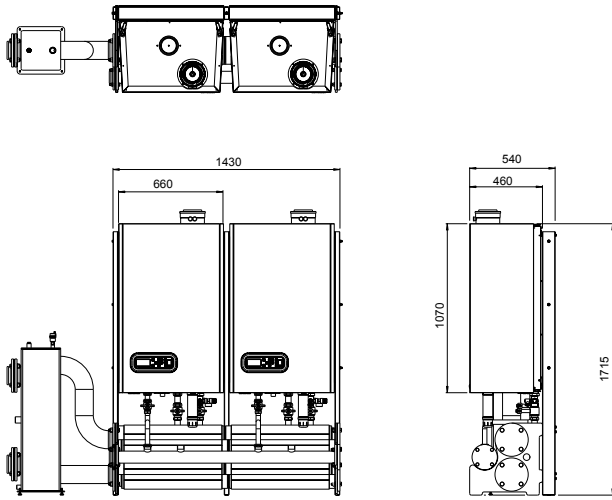

3 Upsilon boilers free-standing back-to-back

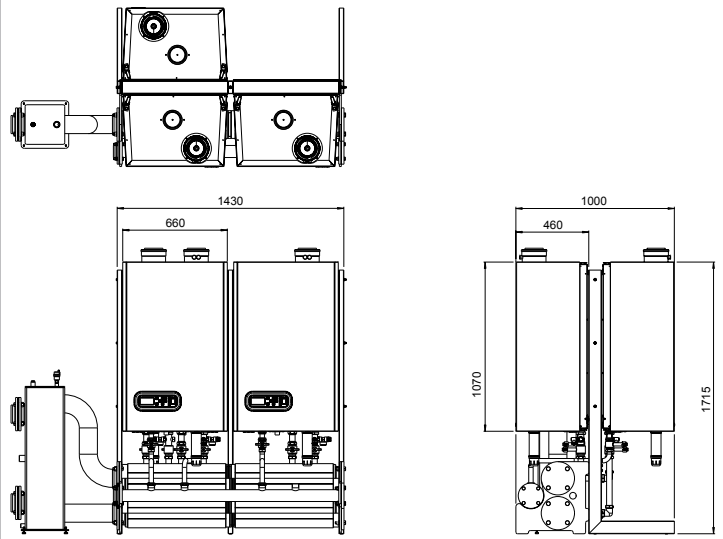

4 Upsilon boilers free-standing in line

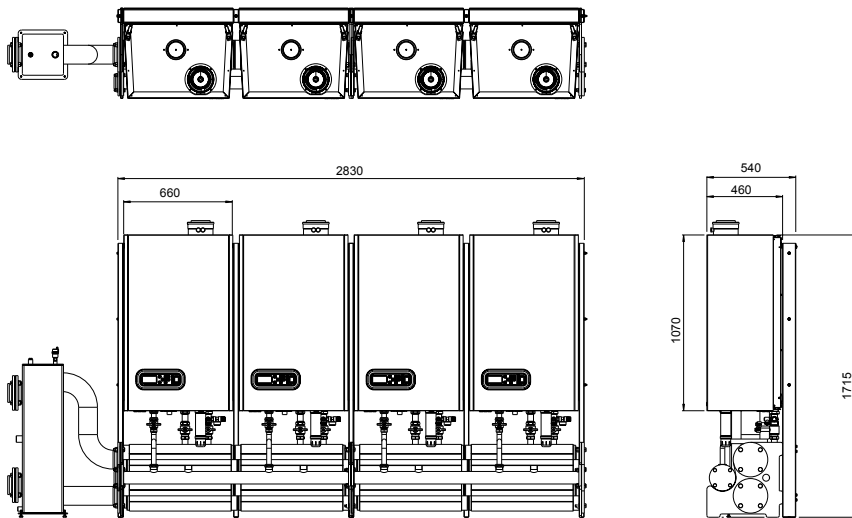

8 Upsilon boilers free-standing in line

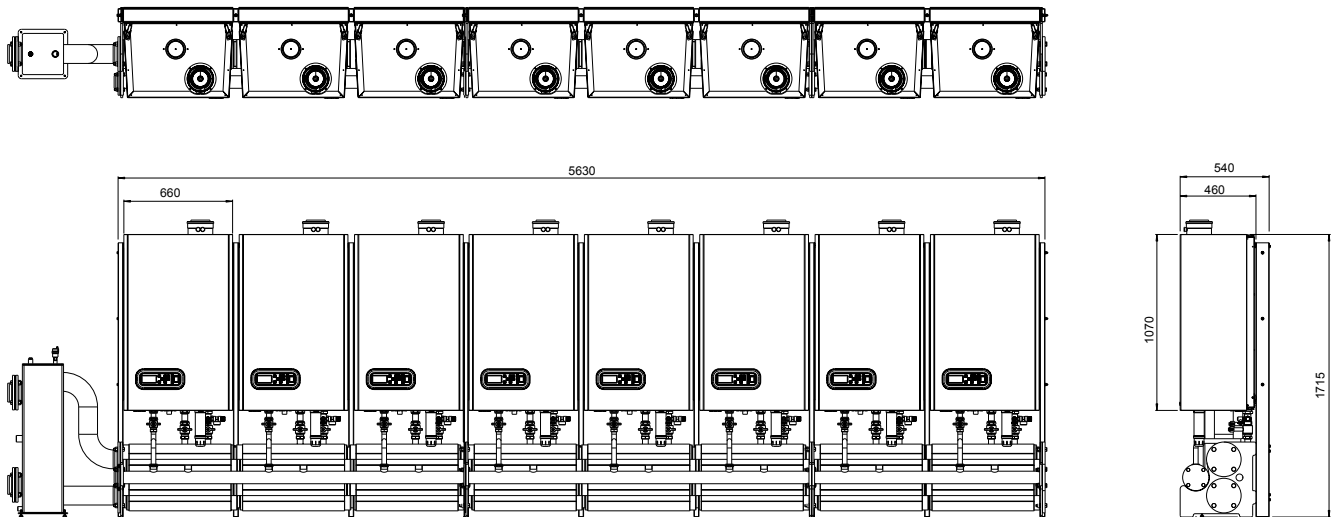

Dimensions flue connections

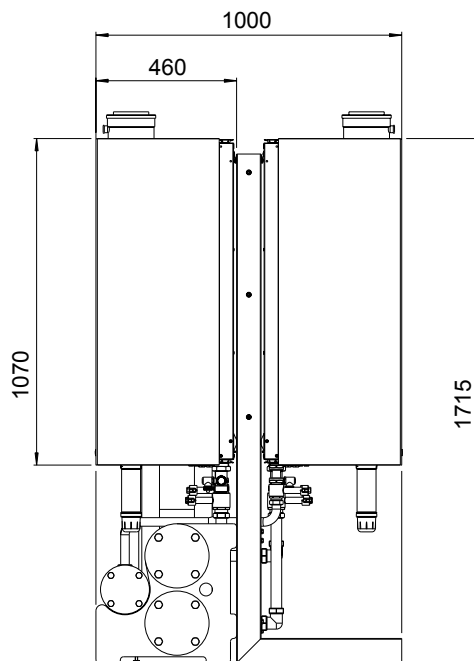
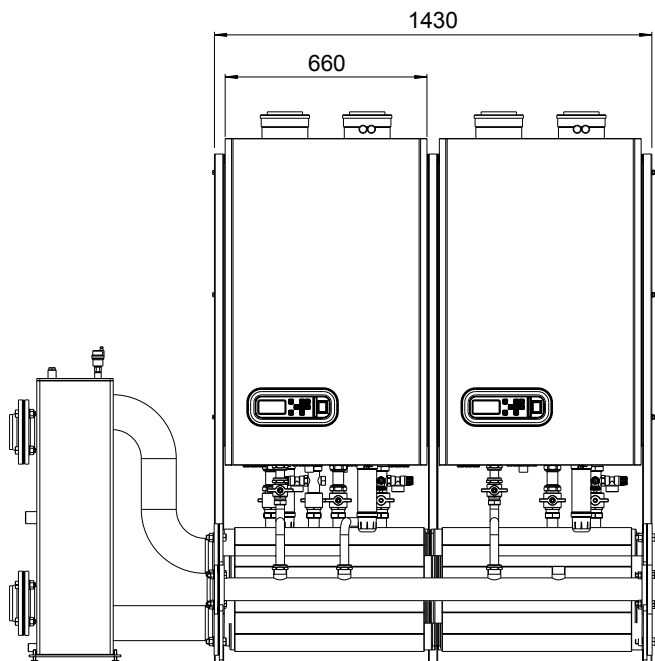
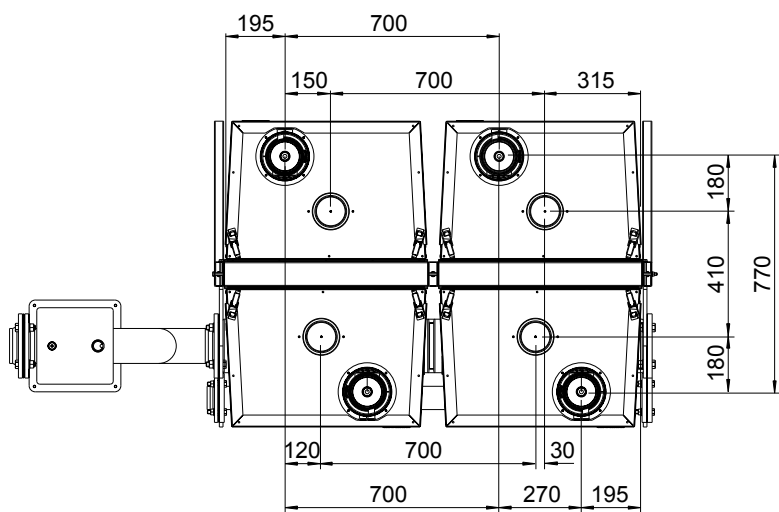

Dimensions low velocity header DN65 until 452kW

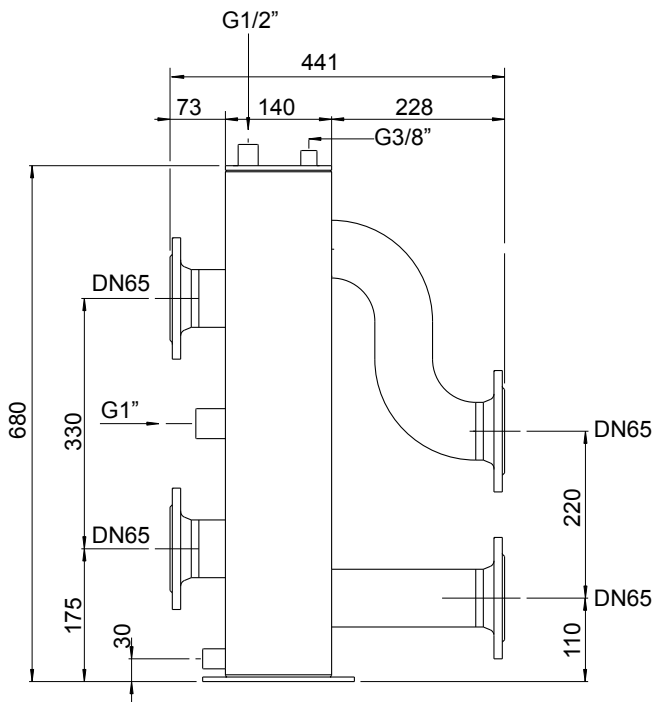

Dimensions main header

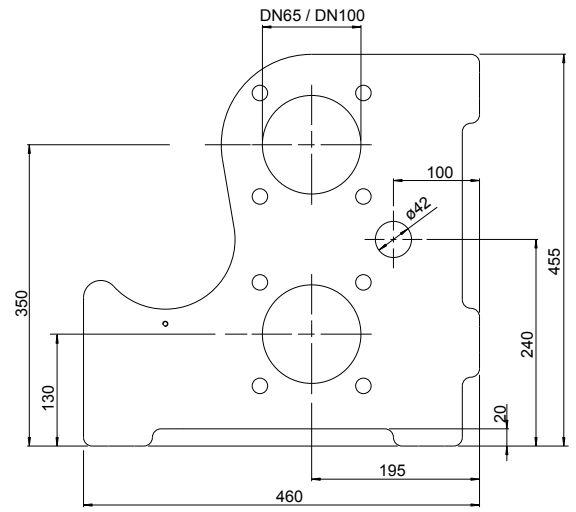

L 2/4 places = 1398mm (DN65/DN100)
 L 3/6 places = 2098mm (DN65/DN100)

Dimensions low velocity header DN100 until 960kW

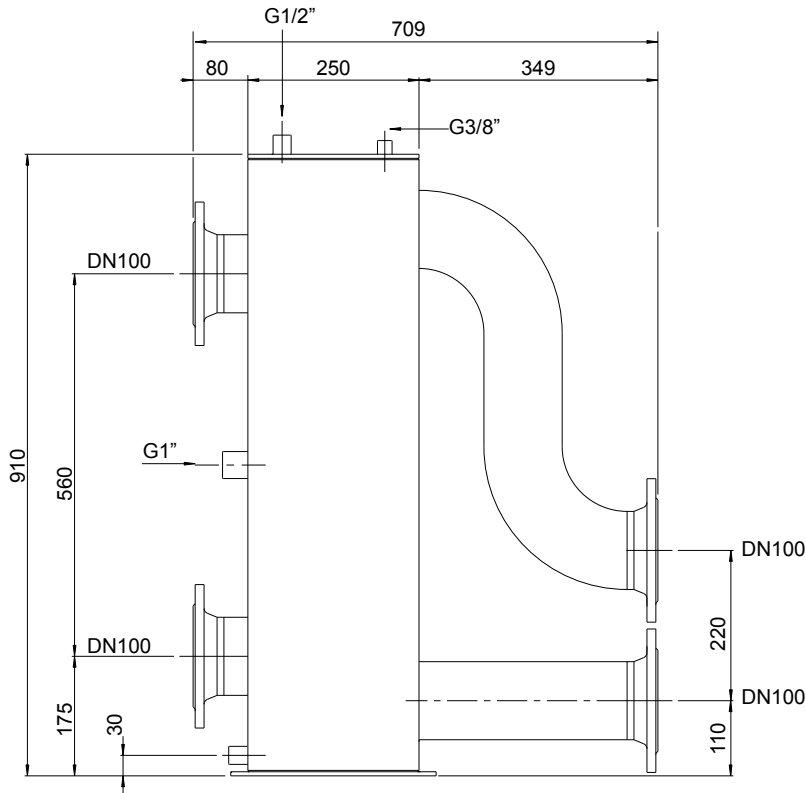

Dimensions bend DN65 and DN100

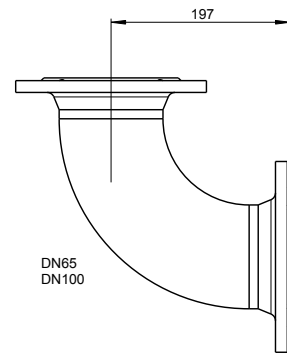



Upsilon 1 boiler, wall hung

Upsilon 2 boilers, wall hung, max.200kW

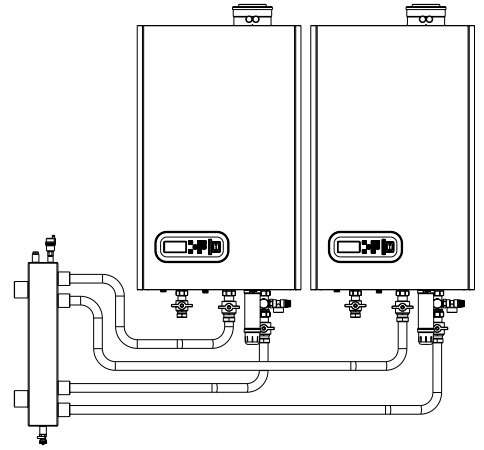
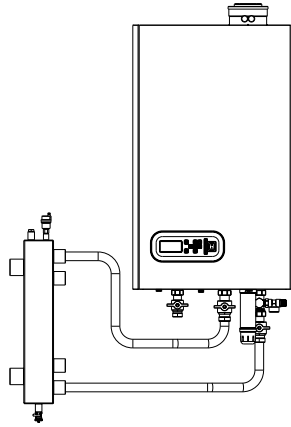
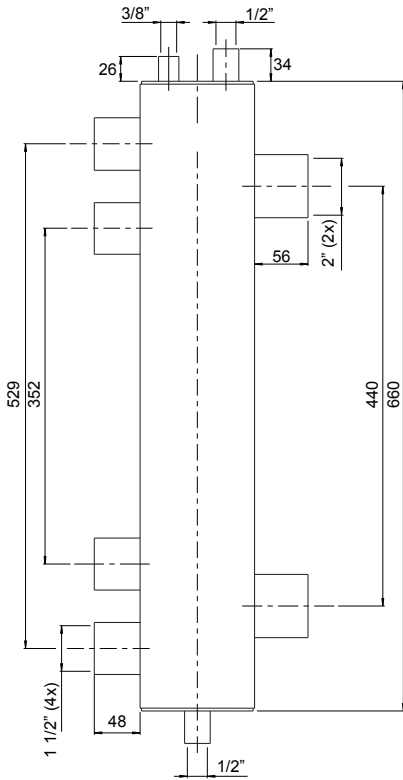

Upsilon 1 boiler, free-standing

Upsilon 2 boilers, free-standing, max. 200kW

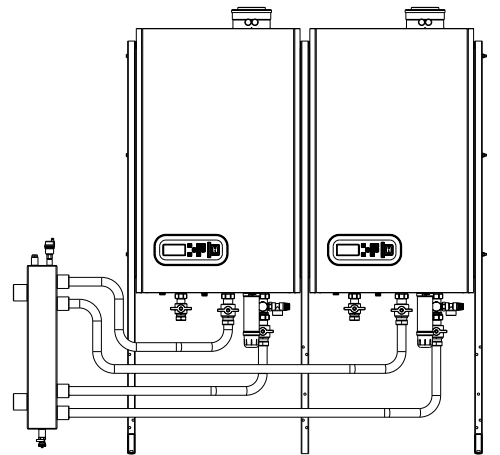
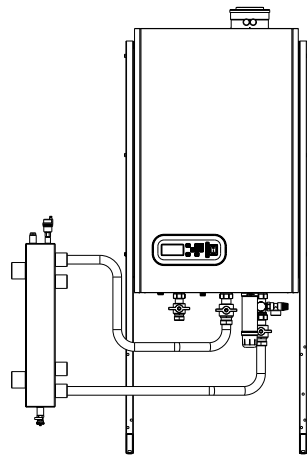

Number of Upsilon-boilers (UB 70, UB 110, UB 140)

Necessary articles:

	wall hung		free standing	
	1	2	1	2
0310265 L-shape frame for back to back alignment			2	2
0310266 I-shape frame for line alignment				1
0310267 Boiler frame			1	2
0310335 Low velocity header for 1 or 2 boilers (max. 200kW)	1	1	1	1
0310286 Boiler connection set for single boiler	1	2	1	2
0310289 Bus communication cable		1		1
0310290 Common flow sensor 10kOhm T3/T10	1	1	1	1

Supply of connection pipes, fittings and brackets by third party.

CE DECLARATION OF CONFORMITY

Hereby declares A.O. Smith Water Products Company B.V. that,
the condensing boiler types: Upsilon UB 70
UB 110
UB 140

are in conformity with the provisions of the following EC Directives, including all amendments, and with national legislation implementing these directives:

<u>Directive</u>		<u>Used standards</u>
Gas Appliance Directive	2009/142/EC	EN483: 2005 EN15420: 2010 EN15417; 2007 EN60335-2-12: 2006 EN60335-1 (partly): 2002
Efficiency Directive	92/42/EEC	EN677: 1998 EN15417: 2007
Low Voltage Directive	2006/95/EG	EN60335-2-102: 2006 EN60335-1 (partly): 2002
EMC Directive	2004/108//EG	EN61000-3-2: 2000 EN61000-3-3: 2001 EN55014-2: 1997 EN55014-1: 2000
Report number		179648

and that the products are in conformity with EC type-examination certificate number E0430, as stated by KIWA-Gastec Certification BV, Apeldoorn, The Netherlands.

Date : 28-06-2012

Signature :

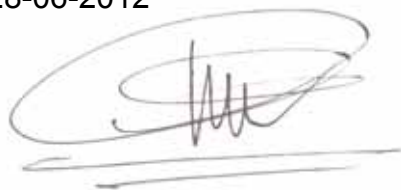

Full name : T. van der Hamsvoort
(General Manager)

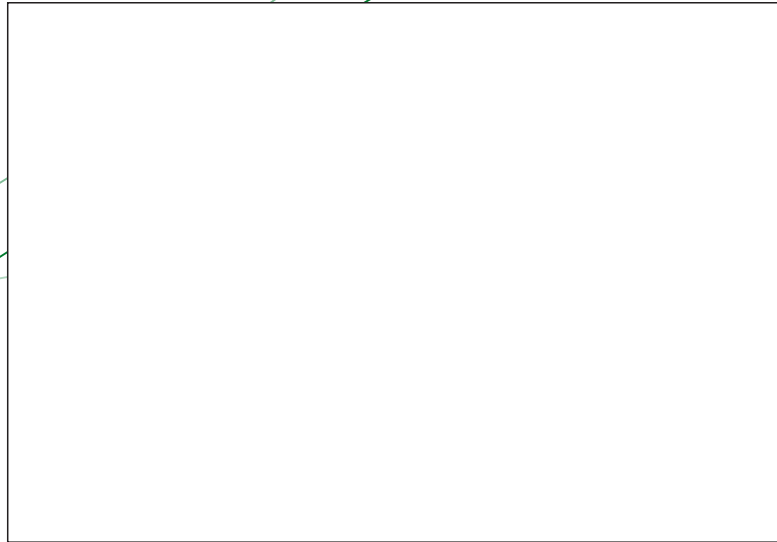

your installer